



Transportation Pooled Fund Program



Texas A&M Transportation Institute

Report No. 405160-32
Report Date: August 2012

REBAR LOCATOR FOR PINNED PRECAST BARRIER APPLICATION

by

Chiara Silvestri, Ph.D.
Associate Research Scientist

and

William F. Williams, P.E.
Associate Research Engineer

Contract No.: T4541-BF

Sponsored by
Roadside Safety Research Program Pooled Fund
Study No. TPF-5(114)

TEXAS A&M TRANSPORTATION INSTITUTE PROVING GROUND

Mailing Address:
Roadside Safety & Physical Security
Texas A&M University System
3135 TAMU
College Station, TX 77843-3135

Located at:
Texas A&M Riverside Campus
Building 7091
3100 State Highway 47
Bryan, TX 77807

DISCLAIMER

The contents of this report reflect the views of the authors who are solely responsible for the facts and accuracy of the data, and the opinions, findings and conclusions presented herein. The contents do not necessarily reflect the official views or policies of the Washington State Department of Transportation, the Roadside Pooled Fund Program, The Texas A&M University System, or Texas A&M Transportation Institute. This report does not constitute a standard, specification, or regulation. In addition, the above listed agencies assume no liability for its contents or use thereof. The names of specific products or manufacturers listed herein do not imply endorsement of those products or manufacturers. Results reported in this study refer to testing completed by Company representatives in a laboratory-controlled environment. The authors do not assume any responsibility if testing of the same specimens with the same devices but performed in a different environment would result in different outcomes.



Chiara Silvestri,
Associate Research Scientist

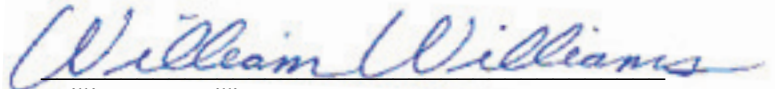

William F. Williams,
Associate Research Engineer

1. Report No.		2. Government Accession No.		3. Recipient's Catalog No.	
4. Title and Subtitle REBAR LOCATOR FOR PINNED PRECAST BARRIER APPLICATION				5. Report Date August 2012	
				6. Performing Organization Code	
7. Author(s) Chiara Silvestri and William F. Williams				8. Performing Organization Report No. Report No. 405160-32	
9. Performing Organization Name and Address Texas A&M Transportation Institute Proving Ground The Texas A&M University System College Station, Texas 77843-3135				10. Work Unit No. (TRAIS)	
				11. Contract or Grant No. T4541 BF	
12. Sponsoring Agency Name and Address Washington State Department of Transportation Transportation Building, MS 47372 Olympia, Washington 98504-7372				13. Type of Report and Period Covered Test Report March 2011 – August 2012	
				14. Sponsoring Agency Code	
15. Supplementary Notes Research Study Title: Task Order #32 – Rebar Locator for Pinned Precast Barrier Application Name of Contacting Representative: Paul Fossier					
16. Abstract The recently approved TL-3 F-shaped precast Louisiana concrete barrier detail has a slotted hole design that allows for shifting of the pin to avoid transverse reinforcement. To avoid rebar in the longitudinal direction, contractors would be required to physically shift the barrier transversely. Contractors often complain that it is often difficult to avoid conflicts with the reinforcing steel. Non Destructive Testing (NDT) methods are popular for routine inspection of bridge members. With the ability of new highly technical systems, some of these NDT techniques can be used for reinforcing steel rebar location in concrete bridge decks without destruction of the members being tested. Use of these techniques has the ability to minimize traffic restrictions related to field data collection and to improve design and asset management. These advanced inspection techniques can be expensive due to the need of having professionally trained technicians to perform the testing and to acquire and analyze the inspection results. Examples of NDT techniques that can be used for rebar location are Ground-Penetrating Radar (GPR) and magnetic devices such as covermeters. The objective of this study was to determine the current NDT methods available for detecting locations of the reinforcing steel in bridge decks. Using NDT methods contractors can accurately locate the placement of the concrete barrier rails in reference to reinforcing steel during construction. Each method was researched to determine advantages and disadvantages. Different devices were studied for comparison of accuracy in detecting rebar location and concrete coverage, ease of use, and training required to operate.					
17. Key Words Rebar locator, concrete coverage, concrete reinforcement, ground penetrating radar, cover meter.			18. Distribution Statement Copyrighted. Not to be copied or reprinted without consent from Washington DOT.		
19. Security Classif.(of this report) Unclassified		20. Security Classif.(of this page) Unclassified		21. No. of Pages 288	22. Price

SI* (MODERN METRIC) CONVERSION FACTORS

APPROXIMATE CONVERSIONS TO SI UNITS

Symbol	When You Know	Multiply By	To Find	Symbol
LENGTH				
in	inches	25.4	millimeters	mm
ft	feet	0.305	meters	m
yd	yards	0.914	meters	m
mi	miles	1.61	kilometers	km
AREA				
in ²	square inches	645.2	square millimeters	mm ²
ft ²	square feet	0.093	square meters	m ²
yd ²	square yard	0.836	square meters	m ²
ac	acres	0.405	hectares	ha
mi ²	square miles	2.59	square kilometers	km ²
VOLUME				
fl oz	fluid ounces	29.57	milliliters	mL
gal	gallons	3.785	liters	L
ft ³	cubic feet	0.028	cubic meters	m ³
yd ³	cubic yards	0.765	cubic meters	m ³
NOTE: volumes greater than 1000 L shall be shown in m ³				
MASS				
oz	ounces	28.35	grams	g
lb	pounds	0.454	kilograms	kg
T	short tons (2000 lb)	0.907	megagrams (or "metric ton")	Mg (or "t")
TEMPERATURE (exact degrees)				
°F	Fahrenheit	5 (F-32)/9 or (F-32)/1.8	Celsius	°C
ILLUMINATION				
fc	foot-candles	10.76	lux	lx
fl	foot-Lamberts	3.426	candela/m ²	cd/m ²
FORCE and PRESSURE or STRESS				
lbf	poundforce	4.45	newtons	N
lbf/in ²	poundforce per square inch	6.89	kilopascals	kPa

APPROXIMATE CONVERSIONS FROM SI UNITS

Symbol	When You Know	Multiply By	To Find	Symbol
LENGTH				
mm	millimeters	0.039	inches	in
m	meters	3.28	feet	ft
m	meters	1.09	yards	yd
km	kilometers	0.621	miles	mi
AREA				
mm ²	square millimeters	0.0016	square inches	in ²
m ²	square meters	10.764	square feet	ft ²
m ²	square meters	1.195	square yards	yd ²
ha	hectares	2.47	acres	ac
km ²	square kilometers	0.386	square miles	mi ²
VOLUME				
mL	milliliters	0.034	fluid ounces	fl oz
L	liters	0.264	gallons	gal
m ³	cubic meters	35.314	cubic feet	ft ³
m ³	cubic meters	1.307	cubic yards	yd ³
MASS				
g	grams	0.035	ounces	oz
kg	kilograms	2.202	pounds	lb
Mg (or "t")	megagrams (or "metric ton")	1.103	short tons (2000 lb)	T
TEMPERATURE (exact degrees)				
°C	Celsius	1.8C+32	Fahrenheit	°F
ILLUMINATION				
lx	lux	0.0929	foot-candles	fc
cd/m ²	candela/m ²	0.2919	foot-Lamberts	fl
FORCE and PRESSURE or STRESS				
N	newtons	0.225	poundforce	lbf
kPa	kilopascals	0.145	poundforce per square inch	lbf/in ²

*SI is the symbol for the International System of Units. Appropriate rounding should be made to comply with Section 4 of ASTM E380.
(Revised March 2003)

ACKNOWLEDGMENTS

This research project was performed under a pooled fund program between the State of Alaska Department of Transportation and Public Facilities, California Department of Transportation (Caltrans), Louisiana Department of Transportation and Development, Minnesota Department of Transportation, Pennsylvania Department of Transportation, Tennessee Department of Transportation, Washington State Department of Transportation, and the Federal Highway Administration. The authors acknowledge and appreciate their guidance and assistance.

Also, the authors would like to give a special thanks to the companies and their representatives that expressed interest in this study and offered their devices and knowledge for testing in this research project:

- Mr Robert Parrillo and Mr. Roger Roberts from Geophysical Survey System, Inc. (GSSI);
- Mr. Tom Siemieniak and Mr. Matthew Monroe from Hilti Corporation;
- Mr. Paul Siwek, Mr. Robert Shaffer and Mr. David Corbett from Proceq USA;
- Mr. Peter Kito from Japan Radio Co. (JRC);
- Mr. Larry D. Olson and Mr. Colin O. Leek from Olson Engineering, Inc.

**Roadside Safety Research
Pooled Fund Committee
CONTACTS**

Revised February 2012

ALASKA

Jeff C. Jeffers, P.E.
Statewide Traffic & Safety Engineer
Alaska Department of Transportation and
Public Facilities
3132 Channel Drive
P.O. Box 112500
Juneau, AK 99811-2500
(907) 465-8962
jeff.jeffers@alaska.gov

CALIFORNIA

John Jewell, P.E.
Caltrans
Office of Materials and Infrastructure
Division of Research and Innovation
5900 Folsom Blvd
Sacramento, CA 95819
(916) 227-5824
(916) 227-5856
john_jewell@dot.ca.gov

LOUISIANA

Paul Fossier, P.E.
Assistant Bridge Design Administrator
Bridge and Structural Design Section
Louisiana Department of Transportation
and Development
1201 Capitol Access Road
P.O. Box 94245
Baton Rouge, LA 70804-9245
(225) 379-1323
Paul.Fossier@la.gov

Justin Peltier, P.E.
Senior Engineer, Bridge Design
(225) 379-1069
(225) 379-1786 (fax)
Justin.Peltier@la.gov

MINNESOTA

Michael Elle, P.E.
Design Standards Engineer
Minnesota Department of Transportation
395 John Ireland Blvd, MS 696
St. Paul, MN 55155-1899
(651) 366-4622
michael.elle@state.mn.us

PENNSYLVANIA

Mark R. Burkhead, P.E.
Standards & Criteria Engineer
Pennsylvania Department of
Transportation
400 North Street
Harrisburg, PA 17105
(717) 783-5110
(717) 705-2379 (fax)
mburkhead@pa.us

TENNESSEE

Jeff Jones,
Assistant Chief Engineer
Tennessee Department of Transportation
Suite 1300
James K. Polk State Office Building
Nashville, TN 37243-0348
(615) 741-2221
Jeff.C.Jones@tn.us

Ali Hangu, P.E.
Civil Engineering Manager
(615) 741-0840
(615) 532-7745 (fax)
Ali.Hangu@tn.us

WASHINGTON

Dave Olson, Chair
Design Policy, Standards,
& Research Manager
Washington State
Department of Transportation
P.O. Box 47329
Olympia, WA 98504-7329
(360) 705-7952
Olsonda@wsdot.wa.gov

Rhonda Brooks
Research Manager
P.O. Box 47372
Olympia, WA 98504-7372
(360) 705-7945
Brookrh@wsdot.wa.gov

**FEDERAL HIGHWAY
ADMINISTRATION**

Richard B. (Dick) Albin, P.E.
Safety Engineer
FHWA Resource Center Safety & Design
Technical Services Team
1711 South Capitol Blvd.
Olympia, WA 98504
(303)550-8804
Dick.Albin@dot.gov

William Longstreet
Highway Engineer
FHWA Office of Safety Design
Room E71-107
1200 New Jersey Avenue, S.E.
Washington, DC
(202)366-0087
Will.Longstreet@dot.gov

**TEXAS A&M TRANSPORTATION
INSTITUTE**

D. Lance Bullard, Jr., P.E.
Research Engineer
Roadside Safety & Physical Security Div.
Texas A&M Transportation Institute
Texas A&M University System
College Station, TX 77843-3135
(979) 845-6153
L-Bullard@tamu.edu

Roger P. Bligh, Ph.D., P.E.
Research Engineer
(979) 845-4377
RBligh@tamu.edu

TABLE OF CONTENTS

<u>Section</u>	<u>Page</u>
CHAPTER 1. INTRODUCTION	1
INTRODUCTION	1
BACKGROUND	1
OBJECTIVES / SCOPE OF RESEARCH	2
CHAPTER 2. REBAR LOCATOR TECHNIQUES	3
NUCLEAR METHODS	3
<i>Direct Transmission Radiometry for Density</i>	3
<i>Radiography</i>	3
MAGNETIC METHODS	4
<i>Covermeters</i>	4
GROUND PENETRATING RADAR METHOD	5
CHAPTER 3. IDENTIFICATION OF AVAILABLE REBAR LOCATOR DEVICES	9
CHAPTER 4. REINFORCED CONCRETE SLABS TESTING	23
CONCRETE SPECIMENS DESIGN	23
<i>Testing Plan for Rebar Location with Covermeters</i>	28
<i>Testing Plan for Rebar Location with Ground Penetrating Radars</i>	29
CHAPTER 5. RESULTS	33
GROUND PENETRATING RADAR RESULTS	33
<i>GSSI Results</i>	33
<i>HILTI Results</i>	56
<i>JRC/Proceq Results</i>	77
<i>IDS/Olson Instruments Results</i>	101
COVERMETERS RESULTS 122	
<i>Proceq (Profoscope⁺)</i>	122
<i>Proceq (Profometer 5⁺)</i>	126
<i>Hilti (Ferroskan PS200)</i>	130
CHAPTER 6. SUMMARY.....	135
GPR DEVICES	135
<i>On-Site Rebars Detection</i>	135
<i>Comments</i>	142
<i>Post-Processed Rebars Detection</i>	143
<i>Comments</i>	150
COVERMETER DEVICES	151
<i>Rebar Size Detection</i>	155
<i>Comments</i>	160

TABLE OF CONTENTS (CONTINUED)

<u>Section</u>	<u>Page</u>
CHAPTER 7. CONCLUSIONS AND IMPLEMENTATION.....	161
GPR DEVICES	161
<i>1-inch Accuracy Results Evaluation.....</i>	<i>161</i>
<i>Ease of Use Comparison.....</i>	<i>170</i>
<i>Need of Training Comparison</i>	<i>179</i>
<i>Price Comparison</i>	<i>179</i>
COVERMETER DEVICES	179
<i>1-inch Accuracy Results Evaluation</i>	<i>179</i>
<i>Ease of Use Comparison.....</i>	<i>186</i>
<i>Need of Training Comparison</i>	<i>186</i>
<i>Price Comparison</i>	<i>186</i>
REFERENCES.....	187
APPENDIX A: LOUISIANA DEPARTMENT OF TRANSPORTATION TEMPORARY PRECAST BARRIER - F SHAPE	189
APPENDIX B: LOUISIANA DEPARTMENT OF TRANSPORTATION DESIGN CRITERIA FOR CONCRETE BRIDGE DECKS	191
APPENDIX C: STUDY OF THE POSSIBLE CONCRETE CURING TIME EFFECT ON GPR DEVICES REBAR LOCATOR CAPABILITIES	201
CONCRETE SPECIMENS DESIGN - CONCRETE CURING EFFECT	202
<i>Testing Plan for Rebar Location with Ground Penetrating Radars - Concrete Curing Influence.....</i>	<i>205</i>
RESULTS - CONCRETE CURING EFFECT	206
<i>Test of January 18, 2012.....</i>	<i>206</i>
<i>Test of February 03, 2012.....</i>	<i>212</i>
APPENDIX D: GSSI - GROUND PENETRATING RADAR - STRUCTURESCAN™ MINI SERIES.....	219
APPENDIX E: HILTI - COVER METER - FERROSCAN PS-200	227
APPENDIX F: HILTI - GROUND PENETRATING RADAR - PS1000 X-SCAN	243
APPENDIX G: PROCEQ - COVER METER - PROFOSCOPE+	247
APPENDIX H: PROCEQ - COVER METER - PROFOMETER®5+.....	251
APPENDIX I: JRC/PROCEQ - PORTABLE GROUND PENETRATING RADAR - HANDY SEARCH	257
APPENDIX J: OLSON ENGINEERING, INC. - GROUND PENETRATING RADAR - ALADDIN SYSTEM	265

LIST OF FIGURES

	<u>Page</u>
Figure 1.1. Typical Bridge Deck Pinning Detail for a Louisiana DOT Temporary Precast Barrier.....	1
Figure 2.1. Direct Transmission Radiometry with Source and Detector External to Test Object (ACI 228.2R-98, 1998).....	3
Figure 2.2. Schematic of Radiographic Method (ACI 228.2R-98, 1998).....	4
Figure 2.3. Covermeter Based on Eddy Current Principle (ACI 228.2R-98, 1998).....	5
Figure 2.4. Reflections of Electromagnetic Radiation Pulse at Interfaces between Materials with Different Relative Dielectric Constants (ACI 228.2R-98, 1998).....	6
Figure 4.1. Reinforced Concrete Specimens.....	24
Figure 4.2. Photographs of Reinforced Concrete Specimen Examples.....	27
Figure 5.1. Data Collection Screen Showing Vertical Cursor Positioned Over Canter of (a) First Layer and (b) Second Layer Rebar.....	33
Figure 5.2. GSSI On-Site Results for 7 inches Thickness Reinforced Specimen.....	34
Figure 5.3. GSSI On-Site Results for 8 inches Thickness Reinforced Specimen.....	35
Figure 5.4. GSSI On-Site Results for 8 inches Thickness Reinforced Specimen Elevated.....	36
Figure 5.5. GSSI On-Site Results for 9.5 inches Thickness Reinforced Specimen (Small Rebars).....	37
Figure 5.6. GSSI On-Site Results for 9.5 inches Thickness Reinforced Specimen (Big Rebars).....	38
Figure 5.7. GSSI On-Site Results for 10 inches Thickness Reinforced Specimen.....	39
Figure 5.8. GSSI On-Site Results for 10 inches Thickness Reinforced Specimen Elevated.....	40
Figure 5.9. GSSI Focused Data After Post-Processing of 7-inch Thick Block Results.....	42
Figure 5.10. GSSI Post-processed Results for 7-inch Thickness Reinforced Specimen.....	43
Figure 5.11. GSSI Focused Data After Post-Processing of 8-inch Thick Block Results.....	44
Figure 5.12. GSSI Post-processed Results for 8-inch Thickness Reinforced Specimen.....	45
Figure 5.13. GSSI Focused Data After Post-Processing of 8-inch Elevated Thick Block Results.....	46
Figure 5.14. GSSI Post-processed Results for 8-inch Thickness Reinforced Specimen Elevated.....	47
Figure 5.15. GSSI Focused Data After Post-Processing of 9.5-inch Thick Block Results (Small Rebars).....	48
Figure 5.16. GSSI Post-processed Results for 9.5-inch Thickness Reinforced Specimen (Small Rebars).....	49
Figure 5.17. GSSI Focused Data After Post-Processing of 9.5-inch Thick Block Results (Big Rebars).....	50
Figure 5.18. GSSI Post-processed Results for 9.5-inch Thickness Reinforced Specimen (Big Rebars).....	51
Figure 5.19. GSSI Focused Data After Post-Processing of 10-inch Elevated Thick Block Results.....	52
Figure 5.20. GSSI Post-processed Results for 10-inch Thickness Reinforced Specimen Elevated.....	53
Figure 5.21. GSSI Focused Data After Post-Processing of 10-inch Thick Block Results.....	54
Figure 5.22. GSSI Post-processed Results for 10-inch Thickness Reinforced Specimen.....	55

LIST OF FIGURES (CONTINUED)

	<u>Page</u>
Figure 5.23. Hilti (PS1000) On-Site Results for 7-inch Thickness Reinforced Specimen.	56
Figure 5.24. Hilti (PS1000) On-Site Results for 8-inch Thickness Reinforced Specimen.	57
Figure 5.25. Hilti (PS1000) On-Site Results for 8-inch Thickness Reinforced Specimen Elevated.	58
Figure 5.26. Hilti (PS1000) On-Site Results for 9.5-inch Thickness Reinforced Specimen (Small Rebars).	59
Figure 5.27. Hilti (PS1000) On-Site Results for 9.5-inch Thickness Reinforced Specimen (Big Rebars).	60
Figure 5.28. Hilti (PS1000) On-Site Results for 10-inch Thickness Reinforced Specimen.	61
Figure 5.29. Hilti (PS1000) On-Site Results for 10-inch Thickness Reinforced Specimen Elevated.	62
Figure 5.30. Hilti Screenshots From Post-Processed Data of 7-inch Thick Block Results.	63
Figure 5.31. Hilti Post-processed Results for 7-inch Thickness Reinforced Specimen.	64
Figure 5.32. Hilti Screenshots From Post-Processed Data of 8-inch Thick Block Results.	65
Figure 5.33. Hilti Post-processed Results for 8-inch Thickness Reinforced Specimen.	66
Figure 5.34. Hilti Screenshots From Post-Processed Data of 8-inch Thick Elevated Block Results.	67
Figure 5.35. Hilti Post-processed Results for 8-inch Thickness Reinforced Specimen Elevated.	68
Figure 5.36. Hilti Screenshots From Post-Processed Data of 9.5-inch Thick Block Results (Small Rebars).	69
Figure 5.37. Hilti Post-processed Results for 9.5-inch Thickness Reinforced Specimen (Small Rebars).	70
Figure 3.38. Hilti Screenshots From Post-Processed Data of 9.5-inch Thick Block Results (Big Rebars).	71
Figure 5.39. Hilti Post-processed Results for 9.5-inch Thickness Reinforced Specimen (Big Rebars).	72
Figure 5.40. Hilti Screenshots From Post-Processed Data of 10-inch Thick Block Results.	73
Figure 5.41. Hilti Post-processed Results for 10-inch Thickness Reinforced Specimen.	74
Figure 5.42. Hilti Screenshots From Post-Processed Data of 10-inch Thick Elevated Block Results.	75
Figure 5.43. Hilti Post-processed Results for 10-inch Thickness Reinforced Specimen Elevated.	76
Figure 5.44. Handy Search Graphical Representation of the Displayed Angular Image Resulting from Locating a Reinforced Steel Bar in Concrete (Proceq, 2012).	77
Figure 5.45. Handy Search Scan Screen Example (During Scanning).	77
Figure 5.46. JRC/Proceq On-Site Results for 7-inch Thickness Reinforced Specimen.	78
Figure 5.47. JRC/Proceq On-Site Results for 8-inch Thickness Reinforced Specimen.	79
Figure 5.48. JRC/Proceq On-Site Results for 8-inch Thickness Reinforced Specimen Elevated.	80
Figure 5.49. JRC/Proceq On-Site Results for 9.5-inch Thickness Reinforced Specimen (Small Rebars).	81

LIST OF FIGURES (CONTINUED)

	<u>Page</u>
Figure 5.50. JRC/Proceq On-Site Results for 9.5-inch Thickness Reinforced Specimen (Big Rebars).....	82
Figure 5.51. JRC/Proceq On-Site Results for 10-inch Thickness Reinforced Specimen.	83
Figure 5.52. JRC/Proceq On-Site Results for 10-inch Thickness Reinforced Specimen Elevated.	84
Figure 5.53. JRC/Proceq Screenshots From Post-Processed Data of 7-inch Thick Block Results.	87
Figure 5.54. JRC/Proceq Post-processed Results for 7-inch Thickness Reinforced Specimen. .	88
Figure 5.55. JRC/Proceq Screenshots From Post-Processed Data of 8-inch Thick Block Results.	89
Figure 5.56. JRC/Proceq Post-processed Results for 8-inch Thickness Reinforced Specimen. .	90
Figure 5.57. JRC/Proceq Screenshots From Post-Processed Data of 8-inch Thick Elevated Block Results.	91
Figure 5.58. JRC/Proceq Post-processed Results for 8-inch Thickness Reinforced Specimen Elevated.....	92
Figure 5.59. JRC/Proceq Screenshots From Post-Processed Data of 9.5-inch Thick Block Results (Small Rebars).....	93
Figure 5.60. JRC/Proceq Post-processed Results for 9.5-inch Thickness Reinforced Specimen (Small Rebars).....	94
Figure 5.61. JRC/Proceq Screenshots From Post-Processed Data of 9.5-inch Thick Block Results (Big Rebars).	95
Figure 5.62. JRC/Proceq Post-processed Results for 9.5-inch Thickness Reinforced Specimen (Big Rebars).	96
Figure 5.63. JRC/Proceq Screenshots From Post-Processed Data of 10-inch Thick Block Results.	97
Figure 5.64. JRC/Proceq Post-processed Results for 10-inch Thickness Reinforced Specimen. .	98
Figure 5.65. JRC/Proceq Screenshots From Post-Processed Data of 10-inch Thick Elevated Block Results.	99
Figure 5.66. JRC/Proceq Post-processed Results for 10-inch Thickness Reinforced Specimen Elevated.....	100
Figure 5.67. Typical Aladdin System Full-Polar GPR field setup.....	101
Figure 5.68. Full-Polar Antenna Layout of the Aladdin GPR system.	103
Figure 5.69. IDS/Olson Instruments On-Site Results for 7-inch Thickness Reinforced Specimen.	104
Figure 5.70. IDS/Olson Instruments On-Site Results for 8-inch Thickness Reinforced Specimen.	105
Figure 5.71. IDS/Olson Instruments On-Site Results for 9.5-inch Thickness Reinforced Specimen (Small Rebars).....	106
Figure 5.72. IDS/Olson Instruments On-Site Results for 9.5-inch Thickness Reinforced Specimen (Big Rebars).	107
Figure 5.73. IDS/Olson Instruments On-Site Results for 10-inch Thickness Reinforced Specimen.	108

LIST OF FIGURES (CONTINUED)

	<u>Page</u>
Figure 5.74. IDS/Olson Instruments On-Site Results for 10-inch Thickness Reinforced Specimen Elevated	109
Figure 5.75. IDS/Olson Instruments Screenshots From Post-Processed Data of 7-inch Thick Block Results.	110
Figure 5.76. IDS/Olson Instruments Post-processed Results for 7-inch Thickness Reinforced Specimen.	111
Figure 5.77. IDS/Olson Instruments Screenshots From Post-Processed Data of 8-inch Thick Block Results.	112
Figure 5.78. IDS/Olson Instruments Post-processed Results for 8-inch Thickness Reinforced Specimen.	113
Figure 5.79. IDS/Olson Instruments Screenshots From Post-Processed Data of 9.5-inch Thick Block Results (Small Rebars).	114
Figure 5.80. IDS/Olson Instruments Post-processed Results for 9.5-inch Thickness Reinforced Specimen (Small Rebars).	115
Figure 5.81. IDS/Olson Instruments Screenshots From Post-Processed Data of 9.5-inch Thick Block Results (Big Rebars).	116
Figure 5.82. IDS/Olson Instruments Post-processed Results for 9.5-inch Thickness Reinforced Specimen (Big Rebars).	117
Figure 5.83. IDS/Olson Instruments Screenshots From Post-Processed Data of 10-inch Thick Block Results.	118
Figure 5.84. IDS/Olson Instruments Post-processed Results for 10-inch Thickness Reinforced Specimen.	119
Figure 5.85. IDS/Olson Instruments Screenshots From Post-Processed Data of 10-inch Thick Elevated Block Results.	120
Figure 5.86. IDS/Olson Instruments Post-processed Results for 10-inch Thickness Reinforced Specimen Elevated.	121
Figure 5.87. Proceq (Profoscope ⁺) Results for 7-inch Thickness Reinforced Specimen.	122
Figure 5.88. Proceq (Profoscope ⁺) Results for 8-inch Thickness Reinforced Specimen.	123
Figure 5.89. Proceq (Profoscope ⁺) Results for 9.5-inch Thickness Reinforced Specimen (Small Rebars).	124
Figure 5.90. Proceq (Profoscope ⁺) Results for 9.5-inch Thickness Reinforced Specimen (Big Rebars).	125
Figure 5.91. Proceq (Profometer 5+) Results for 7-inch Thickness Reinforced Specimen.	126
Figure 5.92. Proceq (Profometer 5+) Results for 8-inch Thickness Reinforced Specimen.	127
Figure 5.93. Proceq (Profometer 5+) Results for 9.5-inch Thickness Reinforced Specimen (Small Rebars).	128
Figure 5.94. Proceq (Profometer 5+) Results for 9.5-inch Thickness Reinforced Specimen (Big Rebars).	129
Figure 5.95. Hilti (Ferroskan) Results for 7-inch Thickness Reinforced Specimen.	130
Figure 5.96. Hilti (Ferroskan) Results for 8-inch Thickness Reinforced Specimen.	131
Figure 5.97. Hilti (Ferroskan) Results for 9.5-inch Thickness Reinforced Specimen (Small Rebars).	132

LIST OF FIGURES (CONTINUED)

	<u>Page</u>
Figure 5.98. Hilti (Ferroskan) Results for 9.5-inch Thickness Reinforced Specimen (Big Rebars).....	133
Figure 6.1. On-Site Results for 7-inch Thickness Reinforced Specimen - SUMMARY.	135
Figure 6.2. On-Site Results for 8-inch Thickness Reinforced Specimen - SUMMARY.	136
Figure 6.3. On-Site Results for 8-inch Thickness Reinforced Specimen Elevated - SUMMARY.	137
Figure 6.4. On-Site Results for 9.5-inch Thickness Reinforced Specimen (Small Rebars) - SUMMARY.....	138
Figure 6.5. On-Site Results for 9.5-inch Thickness Reinforced Specimen (Big Rebars) - SUMMARY.....	139
Figure 6.6. On-Site Results for 10-inch Thickness Reinforced Specimen - SUMMARY.	140
Figure 6.7. On-Site Results for 10-inch Thickness Reinforced Specimen Elevated - SUMMARY.....	141
Figure 6.8. Post-Processed Results for 7-inch Thickness Reinforced Specimen - SUMMARY.	143
Figure 6.9. Post-Processed Results for 8-inch Thickness Reinforced Specimen - SUMMARY.	144
Figure 6.10. Post-Processed Results for 8-inch Thickness Reinforced Specimen Elevated - SUMMARY.....	145
Figure 6.11. Post-Processed Results for 9.5-inch Thickness Reinforced Specimen (Small Rebars) - SUMMARY.....	146
Figure 6.12. Post-Processed Results for 9.5-inch Thickness Reinforced Specimen (Big Rebars) - SUMMARY.....	147
Figure 6.13. Post-Processed Results for 10-inch Thickness Reinforced Specimen - SUMMARY.....	148
Figure 6.14. Post-Processed Results for 10-inch Thickness Reinforced Specimen Elevated - SUMMARY.....	149
Figure 6.15. Covermeters Results for 7-inch Thickness Reinforced Specimen - Summary. ...	151
Figure 6.16. Covermeters Results for 8-inch Thickness Reinforced Specimen - Summary. ...	152
Figure 6.17. Covermeters Results for 9.5-inch Thickness Reinforced Specimen (Small Rebars) - Summary.....	153
Figure 6.18. Covermeters Results for 9.5-inch Thickness Reinforced Specimen (Big Rebars) - Summary.....	154
Figure 7.1. On-Site GPR Rebar Location Results for 7-inch Thickness Reinforced Specimen - SUMMARY.....	164
Figure 7.2. On-Site GPR Rebar Location Results for 8-inch Thickness Reinforced Specimen - SUMMARY.....	165
Figure 7.3. On-Site GPR Rebar Location Results for 9.5-inch Thickness Reinforced Specimen (Small Rebars) - SUMMARY.....	166
Figure 7.4. On-Site GPR Rebar Location Results for 9.5-inch Thickness Reinforced Specimen (Big Rebars) - SUMMARY.....	167
Figure 7.5. On-Site GPR Rebar Location Results for 10-inch Thickness Reinforced Specimen - SUMMARY.....	168

LIST OF FIGURES (CONTINUED)

	<u>Page</u>
Figure 7.6. On-Site GPR Rebar Location Results for 10-inch Thickness Reinforced Specimen (Elevated) - SUMMARY.....	169
Figure 7.7. Post-Processed GPR Rebar Location Results for 7-inch Thickness Reinforced Specimen - SUMMARY.....	173
Figure 7.8. Post-Processed GPR Rebar Location Results for 8-inch Thickness Reinforced Specimen - SUMMARY.....	174
Figure 7.9. Post-Processed GPR Rebar Location Results for 9.5-inch Thickness Reinforced Specimen (Small Rebars) - SUMMARY.....	175
Figure 7.10. Post-Processed GPR Rebar Location Results for 9.5-inch Thickness Reinforced Specimen (Big Rebars) - SUMMARY.....	176
Figure 7.11. Post-Processed GPR Rebar Location Results for 10-inch Thickness Reinforced Specimen - SUMMARY.....	177
Figure 7.12. Post-Processed GPR Rebar Location Results for 10-inch Thickness Reinforced Specimen (Elevated) - SUMMARY.....	178
Figure 7.13. Covermeters Rebar Location Results for 7-inch Thickness Reinforced Specimen - SUMMARY.....	181
Figure 7.14. Covermeters Rebar Location Results for 8-inch Thickness Reinforced Specimen - SUMMARY.....	182
Figure 7.15. Covermeters Rebar Location Results for 9.5-inch Thickness Reinforced Specimen (Small Rebars) - SUMMARY.....	183
Figure 7.16. Covermeters Rebar Location Results for 9.5-inch Thickness Reinforced Specimen (Big Rebars) - SUMMARY.....	184
Figure 7.17. Covermeters Rebar Location Results for 10-inch Thickness Reinforced Specimen - SUMMARY.....	185
Figure A.1. Louisiana Department of Transportation Temporary Precast Barrier - F Shape... 190	
Figure C.1. Reinforced Concrete Specimens.....	204
Figure C.2. GPR Results for Slab #1 - 8-inch Thickness Reinforced Specimen (Concrete Curing Effect) - Summary for January 18, 2012 Testing.....	206
Figure C.3. GPR Scanning Images for Transverse Rebars for Slab #1 taken on January 18, 2012 - Summary for 29-day Old Reinforced Specimen.....	207
Figure C.4. GPR Scanning Images for Longitudinal Rebars for Slab #1 taken on January 18, 2012 - Summary for 29-day Old Reinforced Specimen.....	208
Figure C.5. GPR Results for Slab #2 - 8-inch Thickness Reinforced Specimen (Concrete Curing Effect) - Summary for January 18, 2012 Testing.....	209
Figure C.6. GPR Scanning Images for Transverse Rebars for Slab #2 taken on January 18, 2012 - Summary for 16-day Old Reinforced Specimen.....	210
Figure C.7. GPR Scanning Images for Longitudinal Rebars for Slab #2 taken on January 18, 2012 - Summary for 16-day Old Reinforced Specimen.....	211
Figure C.8. GPR Results for Slab #1 - 8-inch Thickness Reinforced Specimen (Concrete Curing Effect) - Summary for February 03, 2012 Testing.....	212
Figure C.9. GPR Scanning Images for Transverse Rebars for Slab #1 taken on February 03, 2012 - Summary for 45-day Old Reinforced Specimen.....	213

LIST OF FIGURES (CONTINUED)

	<u>Page</u>
Figure C.10. GPR Scanning Images for Longitudinal Rebars for Slab #1 taken on February 03, 2012 - Summary for 45-day Old Reinforced Specimen.	214
Figure C.11. GPR Results for Slab #2 - 8-inch Thickness Reinforced Specimen (Concrete Curing Effect) - Summary for February 03, 2012 Testing.	215
Figure C.12. GPR Scanning Images for Transverse Rebars of Slab #2 taken on February 03, 2012 - Summary for 32-day Old Reinforced Specimen.	216
Figure C.13. GPR Scanning Images for Longitudinal Rebars of Slab #2 taken on February 03, 2012 - Summary for 32-day Old Reinforced Specimen.	217

LIST OF TABLES

	<u>Page</u>
Table 2.1. Advantages and Limitations of Non-Destructive Testing Methods for Rebar Locator (adapted from ACI 228.2R-98, 1998 and IAEA, 2002).	7
Table 3.1. Manufacturers and Models of Covermeters Devices Identified on the Market.	9
Table 3.2. Manufacturers (and Distributors) and Models of GPR Devices Identified on the Market.	10
Table 3.3. Sizes and Features of Covermeter Devices Identified on the Market.	11
Table 3.4. Performances of Covermeter Devices Identified on the Market.	14
Table 3.5. Sizes and Features of GPR Devices Identified on the Market.	19
Table 3.6. Performances of GPR Devices Identified on the Market.	20
Table 5.1. JRC Post-Processing Methodology to Determine the Correct Rebars Location.	85
Table 6.1. Covermeters Rebar Size Detection Comparison for 7-inch Thickness Reinforced Specimen.	156
Table 6.2. Covermeters Rebar Size Detection Comparison for 8-inch Thickness Reinforced Specimen.	157
Table 6.3. Covermeters Rebar Size Detection Comparison for 9.5-inch Thickness Reinforced Specimen (Small Rebars).	158
Table 6.4. Covermeters Rebar Size Detection Comparison for 9.5-inch Thickness Reinforced Specimen (Big Rebars).	159
Table 7.1. On-Site Summary GPR Results - Rebar Location.	161
Table 7.2. On-Site Summary GPR Results - Rebar Concrete Coverage.	163
Table 7.3. Post-Processed GPR Results - Rebar Location.	171
Table 7.4. Post-Processed GPR Results - Rebar Concrete Coverage.	172
Table 7.5. Covermeters Results - Rebar Location.	180
Table 7.6. Covermeters Results - Rebar Concrete Coverage.	180

CHAPTER 1. INTRODUCTION

INTRODUCTION

The use of the recently approved TL-3 F-shaped precast concrete barrier detail is often used in reinforced concrete bridge decks where both transverse and longitudinal reinforcing steel exists. The current Louisiana barrier detail (Figure 1.1 and Appendix A) has a slotted hole design that allows for shifting of the pin to avoid transverse reinforcement. To avoid rebar in the longitudinal direction, the Contractor would be required to physically shift the barrier transversely. Contractors often complain that the barrier and pin connection is often difficult to avoid conflicts with the reinforcing steel and many lack knowledge of or do not wish to use Non Destructive Testing (NDT) methods to locate reinforcing steel in bridge decks.

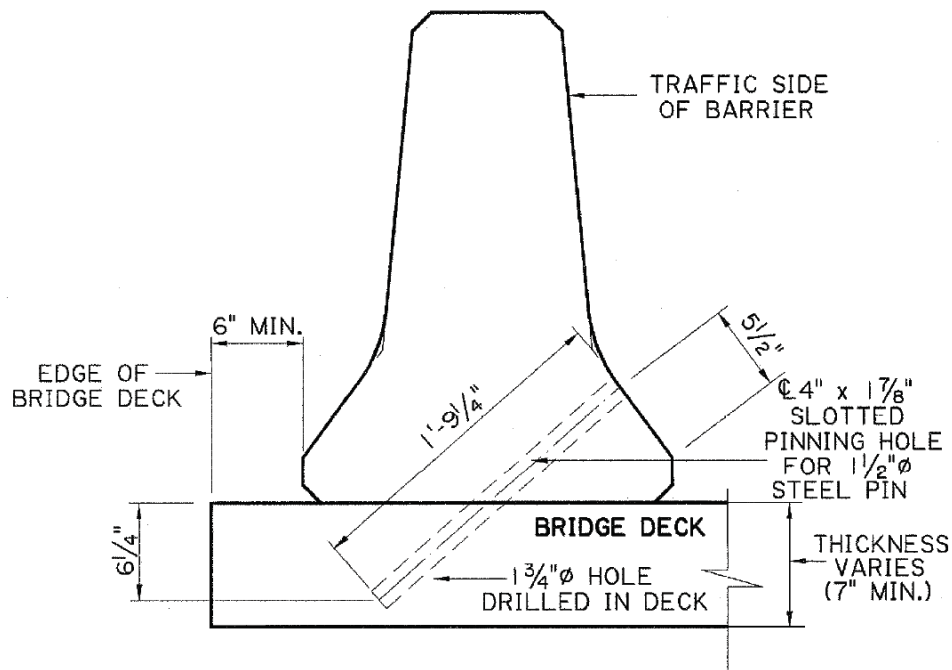

Figure 1.1. Typical Bridge Deck Pinning Detail for a Louisiana DOT Temporary Precast Barrier.

BACKGROUND

Non Destructive Testing (NDT) methods are popular for routine inspection of bridge members. Also, thanks to new technology developments, they are becoming more economically feasible for bridge inspection. With the ability of new highly technical systems, some of these NDT techniques can be used for reinforcing steel rebar location in concrete bridge decks without destruction of the members being tested.

Use of these techniques has the ability to minimize traffic restrictions related to field data collection and to improve design and asset management. They can be applied to pre- and post-construction performance monitoring and data collection while considerably minimizing unwelcome delays related to highway renewal. These advanced inspection techniques can be expensive due to the need of having professionally trained technicians to perform the testing and to acquire and analyze the inspection results. Also, some of these methods require calibrated testing equipment (Wimsatt et al., 2009). Examples of NDT techniques that can be used for rebar location are Ground-Penetrating Radar (GPR) , laser ultrasonic testing, magnetic devices such as pachometers and magnetic imaging tools.

OBJECTIVES / SCOPE OF RESEARCH

The objective of this study was to perform a literature search to determine the current NDT methods available for detecting locations of the reinforcing steel in bridge decks. Using NDT methods, contractors can more accurately locate the placement of the concrete barrier rails during construction. Each method was researched to determine equipment cost, user cost, and advantages/disadvantages.

CHAPTER 2. REBAR LOCATOR TECHNIQUES

This Chapter illustrates the primary techniques the literature indicates for use to detect steel rebar embedded in concrete structures. Three methods were identified: nuclear, magnetic and ground penetrating radar method. For each method, principles are discussed and advantages and disadvantages are summarized in Table 2.1.

NUCLEAR METHODS

Nuclear methods (also called radioactive methods) for nondestructive evaluation of concrete can be subdivided into two groups: *radiometric method* and *radiographic method*. Radiometry procedure, then, can be based on measurement of gamma rays after transmission directly through the concrete, or on measurement of gamma rays reflected, or backscattered, from within the concrete. Radiography involves the use of the radiation passing through the test object to produce a “photograph” of the internal structure of the concrete.

Direct Transmission Radiometry for Density

Figure 2.1 shows the principle for the direct transmission radiometry for density method: a radiation source is placed on one side of the concrete element to be tested, while the detector is placed on the opposite side. As the radiation passes through the concrete, a portion of the radiation is scattered by free electrons. A change in concrete density causes a change in the intensity of the detected radiation.

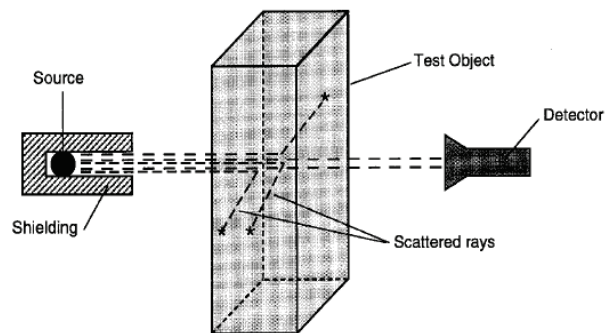

Figure 2.1. Direct Transmission Radiometry with Source and Detector External to Test Object (ACI 228.2R-98, 1998).

Radiography

Radiography is used to obtain a photograph of the interior of concrete. Denser materials block more radiation. Figure 2.2 shows the principle of radiometry: a radiation source is placed on one side of the test object to emit radiation which strikes a special photographic film on the opposite side of the object. The presence of a high density material, such as reinforcement, would be shown on the developed film as a light area.

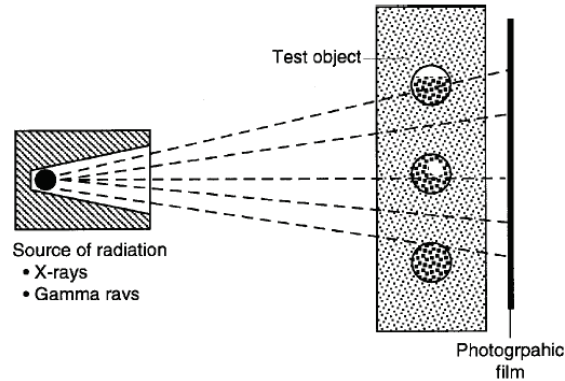

Figure 2.2. Schematic of Radiographic Method (ACI 228.2R-98, 1998).

MAGNETIC METHODS

Covermeters are used to locate reinforcing bars and estimate the concrete coverage. To monitor corrosion activity, the half-cell potential method is generally used, while information on rate of corrosion is obtained from linear-polarization methods.

Covermeters

Covermeters are devices that are used to identify the concrete coverage of rebars. Commercial covermeters are divided into two classes: those based on the principle of magnetic reluctance, and those based on eddy currents.

Eddy-current meters

Figure 2.3 shows a covermeter based on Eddy current principle. When the coil is brought near a steel reinforcing bar, eddy currents are started within the surface of the bar. They induce an alternating secondary magnetic field that starts a secondary current in the coil. The secondary current opposes the primary current. The resulting change in voltage can be utilized for the detection of the steel rebar and for the measurement. In fact, the presence of a steel bar is inferred by monitoring the change in current flowing through the coil. Eddy current covermeters depend on the electrical conductivity of the bar: they can detect both magnetic and non-magnetic (metallic) objects.

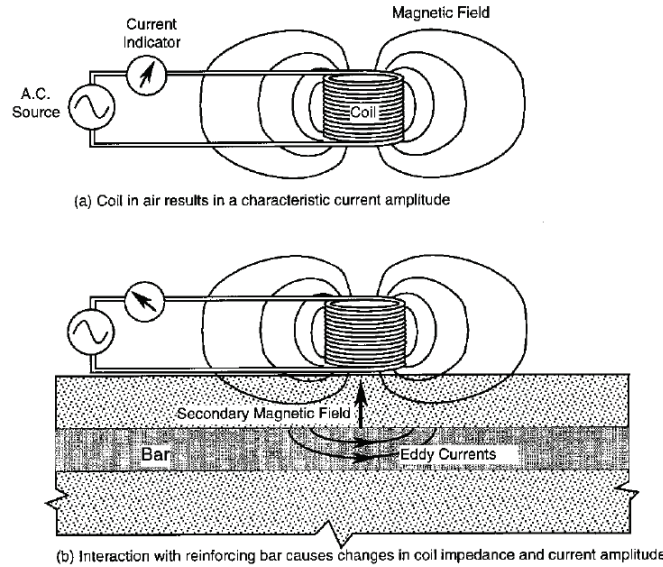
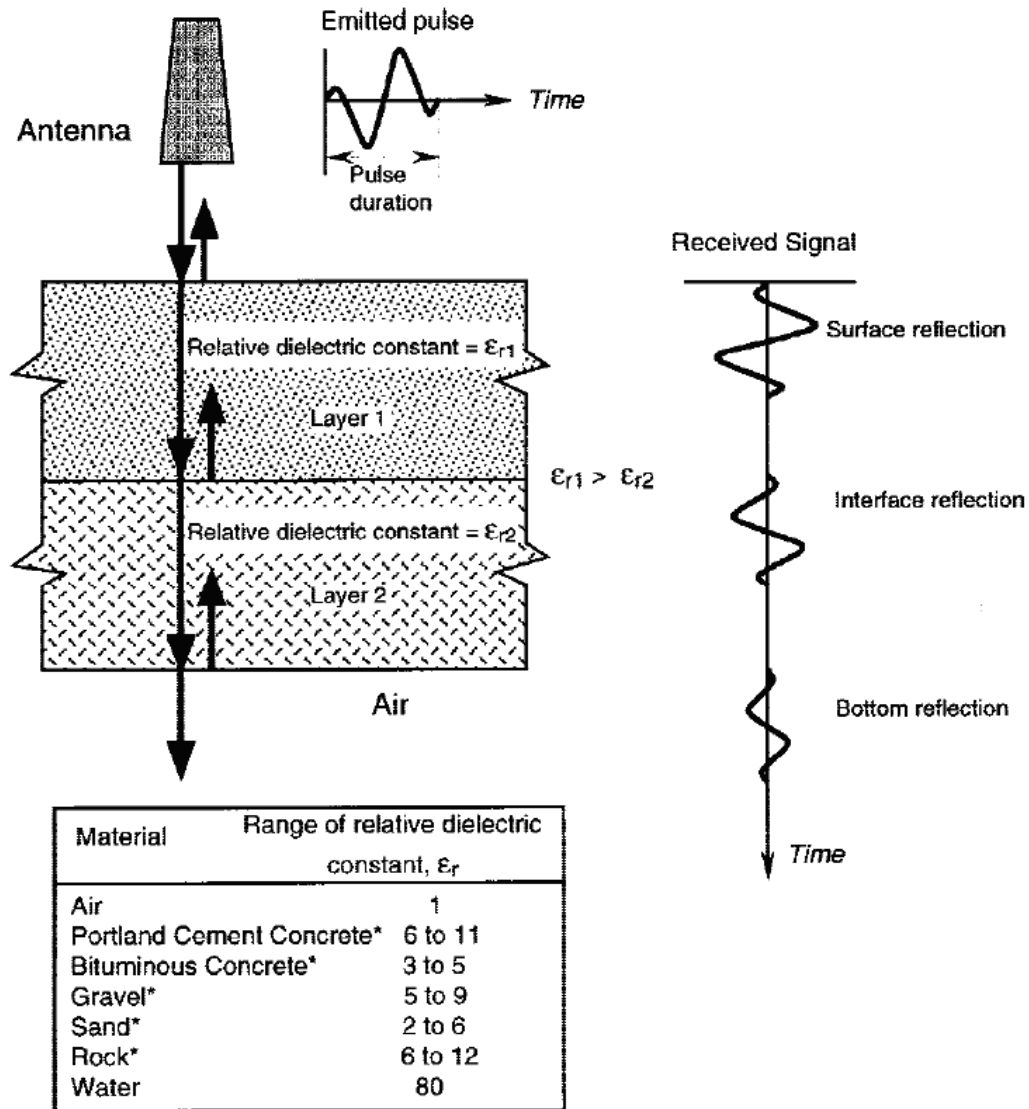

Figure 2.3. Covermeter Based on Eddy Current Principle (ACI 228.2R-98, 1998).

GROUND PENETRATING RADAR METHOD

Figure 2.4 shows the operating principle of the Ground Penetrating Radar (GPR) method. An antenna is employed to transmit short pulses of electromagnetic energy which penetrate into the tested material. When the electromagnetic energy encounter an interface between materials that have different dielectric properties (or dielectric permittivity), part of this energy is reflected back to the antenna. The reflected energy is received back by the antenna and generates a signal which is proportional to the amplitude of the reflected electromagnetic field. The received signal contains information on what was reflected, the speed of the signal, and attenuation of the signal. The transmitted and reflected energy are affected by the dielectric constant and the conductivity of the surveyed material. An analysis of the waveforms allows determination of the depth of the reflecting interface, once the relative dielectric constant is known (or assumed). The concrete coverage can be obtained by measuring the wave speed and travel time.

The moisture content affects the dielectric constant of the concrete. If the moisture content increases, the dielectric constant of the material would also increase. GPR is not as sensitive to the detection of concrete-air interfaces as other methods are (like stress-wave method): GPR is able to penetrate beyond a concrete-air interface and perceive features below such interface.



* ASTM D 4748

Figure 2.4. Reflections of Electromagnetic Radiation Pulse at Interfaces between Materials with Different Relative Dielectric Constants (ACI 228.2R-98, 1998).

Table 2.1. Advantages and Limitations of Non-Destructive Testing Methods for Rebar Locator
(adapted from ACI 228.2R-98, 1998 and IAEA, 2002).

NDT Method	Advantages	Limitations
❖ <u>Nuclear Methods</u>		
Direct Transmission Radiometry	<ul style="list-style-type: none"> ❖ Portable equipment available for determination of in-place density ❖ Minimal operator skill is required 	<ul style="list-style-type: none"> ❖ Operators must be licensed ❖ Available equipment limited to path lengths less than 300 mm ❖ Requires access to inside of member or opposite faces
Radiography	<ul style="list-style-type: none"> ❖ Provides view of the internal structure of the test object 	<ul style="list-style-type: none"> ❖ Operators must be licensed and highly skilled ❖ X-ray equipment is bulky and expensive ❖ Difficult to identify cracks perpendicular to radiation beam ❖ Gamma-ray penetration limited to 500 mm of concrete ❖ Problem for health and safety both for the operatives and those in the vicinity as it requires long radiation exposure time ❖ Areas must be isolated from public
❖ <u>Magnetic Methods</u>		
<u>Covermeters</u>	<ul style="list-style-type: none"> ❖ Able to locate reinforcing bars and other embedded metal objects ❖ Equipment is lightweight, portable, and easy to use ❖ Cover depth can be estimated ❖ Misleading results can be given by the presence and interference of closely spaced reinforcing bars with magnetic properties ❖ Bar diameter must be known if a true indication of cover is to be obtained 	<ul style="list-style-type: none"> ❖ Accuracy for estimated cover depth affected by bar size and bar spacing ❖ Bar diameters difficult to estimate with precision ❖ Cannot identify presence of second layer of reinforcement ❖ Ability to discern individual bars is affected by the meter design, cover depth, and bar spacing ❖ Meters based on magnetic reluctance can detect only ferromagnetic objects ❖ Maximum penetration is limited and depends on meter design ❖ The maximum range of the instrument for practical purposes is about 100 mm

Table 2.1. Advantages and Limitations of Non-Destructive Testing Methods for Rebar Locator
(adapted from ACI 228.2R-98, 1998 and IAEA, 2002) (Continued).

NDT Method	Advantages	Limitations
❖ <u>Ground Penetrating Radar</u>		
<p><u>Ground- Penetrating Radar</u></p>	<ul style="list-style-type: none"> ❖ Sensitive to presence of embedded metal objects ❖ Ability to penetrate across concrete-air interfaces ❖ Ability to locate multiple layers of reinforcement ❖ Ability of locating steel rebars at deeper concrete coverage than with other devices such as covermeters 	<ul style="list-style-type: none"> ❖ Region irradiated by antenna is limited to cone-shaped volume directly below antenna ❖ Congested reinforcement can prevent penetration beyond the reinforcement ❖ Cracks and delaminations are not easy to detect unless moisture is also present in the cracks or region of the delamination ❖ Experienced operator required to operate equipment and interpret results: large amount of data obtained during scans ❖ With increasing depth, low level signals from small targets are harder to detect due to signal attenuation ❖ Relatively expensive to use ❖ Sensitive to the curing time of the concrete

CHAPTER 3. IDENTIFICATION OF AVAILABLE REBAR LOCATOR DEVICES

After performing a detailed literature review and understanding both advantages and limitations of each rebar locator method, the researchers decided to focus on detecting covermeter and ground penetrating radar (GPR) devices available on the market. Extensive research was conducted to identify manufacturers of such devices (Tables 3.1 and 3.2).

Table 3.1. Manufacturers and Models of Covermeters Devices Identified on the Market.

Manufacturers	Model
Zircon	<i>Multiscanner Pro SL</i>
	<i>Multiscanner i320 OneStep</i>
	<i>Multiscanner i520 OneStep</i>
	<i>MetalliScanner m40</i>
	<i>MetalliScanner MT 6</i>
Milwaukee	<i>Sub-Scanner M12 Cordless Lithium-ion detection tool Kit 2290-21</i>
NDT James	<i>Mini R-Meter</i>
	<i>R-Meter MK III</i>
CCP	<i>Fisher M-101</i>
Proceq	<i>Profometer 5+ cover meter Model S</i>
	<i>Profometer 5+ cover meter Model Scanlog</i>
	<i>Profoscope</i>
	<i>Profoscope+</i>
Elcometer	<i>Elcometer P100 Imp</i>
	<i>Elcometer P120</i>
	<i>Elcometer P150</i>
	<i>Elcometer 331 Model B</i>
	<i>Elcometer 331 Model BH</i>
	<i>Elcometer 331 Model SH</i>
	<i>Elcometer 331 Model TH</i>
	<i>Elcometer 331 Model THD</i>
Protovale	<i>CM52</i>
	<i>CM9</i>
GSSI	<i>StructureScan Optical</i>
	<i>StructureScan Standard</i>
	<i>StructureScan Mini</i>
	<i>StructureScan Mini HR</i>
Hilti	<i>PS30 Ferrodetector</i>
	<i>PS35 Ferrodetector</i>
	<i>PS200 Ferrosan</i>

Table 3.2. Manufacturers (and Distributors) and Models of GPR Devices Identified on the Market.

Manufacturer	U.S. Distributors	Model
Geophysical Survey Systems, Inc. (GSSI) - USA	GSSI	<i>StructureScan Optical</i>
		<i>StructureScan Standard</i>
		<i>StructureScan Mini</i>
		<i>StructureScan Mini HR</i>
Hilti LIECHTENSTEIN	Hilti USA	<i>PS1000 X-Scan</i>
Japan Radio Corporation (JRC) - JAPAN	Proceq USA, Inc.	<i>Handy Search</i>
Ingegneria Dei Sistemi (IDS) - ITALY	Olson Instruments, Inc.	<i>Aladdin System</i>

Once the manufacturers and the devices available on the market were identified, the researchers collected and compared all retrievable information on size, features and performance for the device available (summarized in Tables 3.3 to 3.6)

Table 3.3. Sizes and Features of Covermeter Devices Identified on the Market.

Manufacturers	Model	Dimensions	Weight	Operating Temperature	Storage Temperature	Water Resistance	Charge Time	Data Storage
Zircon								
	Multiscanner Pro SL	6.38" x 3.07" x 1.34"	6.5 oz. (184 g) w/out battery	20 to 120 deg. F	- 20 to 150 deg. F	Splash and water resistant, not waterproof	N/A	N/A
	Multiscanner i320 OneStep	7.25" x 3.2" x 1.4"	11 oz. (312 g) w/out battery	40 to 120 deg. F	14 to 140 deg. F	Splash and water resistant, not waterproof	N/A	N/A
	Multiscanner i520 OneStep	7.25" x 3.2" x 1.4"	9.4 oz. (262 g) w/out battery	40 to 120 deg. F	14 to 140 deg. F	Splash and water resistant, not waterproof	N/A	N/A
	MetalliScanner m40	7.5" x 5.5" x 1.1"	3.9 oz. (111 g) w/out battery	40 to 120 deg. F	- 20 to 150 deg. F	Splash and water resistant, not waterproof	N/A	N/A
	MetalliScanner MT 6	8.87" x 3.84" x 2.23"	10.1 oz. (286 g) w/out battery	20 to 120 deg. F	- 20 to 150 deg. F	Splash and water resistant, not waterproof	N/A	N/A
Milwaukee								
	Sub-Scanner M12 Cordless Lithium-ion detection tool Kit 2290-21	N/A	N/A	N/A	N/A	N/A	30 min	N/A
NDT James								
	Mini R-Meter	N/A	3.5 lbs (1.60 Kg)	23 to 113 deg. F	N/A	N/A	4 hr	Store data for later upload via USB
	R-Meter MK III	4.88" x 9.68" x 10.63"	5.4 lbs (2.5 Kg)	N/A	N/A	Rugged and splash resistant case	4-6 hr	Built in memory can store over 80,000 individual data points
CCP								
	Fisher M-101	Control: 3" x 6" x 6" Handle: 0.75" x 23"	2.8 lbs (1.3 Kg)	N/A	N/A	Fully waterproof search loop	N/A	N/A

Table 3.3. Sizes and Features of Covermeter Devices Identified on the Market (Continued).

Manufacturers	Model	Dimensions	Weight	Operating Temperature	Storage Temperature	Water Resistance	Charge Time	Data Storage
Proceq								
	Profometer 5+, Model S	Indicating Device: 7" x 7" x 3" Probe: 4.25" x 2" x 1.12"	9.25 lbs (4.2 Kg) w/carrying case and acc.	-10 to 60 deg. C (0 to 140 deg. F)	N/A	Yes	45h operation batteries, 30h with backlight on	Storage of 40,000 individual cover values
	Profometer 5+, Model Scanlog	Indicating Device: 7" x 7" x 3" Probe: 4.25" x 2" x 1.12"	10 lbs (4.5 Kg) w/carrying case and acc.	-10 to 60 deg. C (0 to 140 deg. F)	N/A	Yes	45h operation batteries, 30h with backlight on	Storage of 40,000 individual cover values
	Profoscope	8" x 3.6" x 1.6"	0.73 lbs (0.33 Kg)	-10 to 60 deg. C (0 to 140 deg. F)	N/A	Yes - IP54 Protection Class	> 50h backlight off, > 15h backlight on	N/A
	Profoscope+	8" x 3.6" x 1.6"	0.73 lbs (0.33 Kg)	-10 to 60 deg. C (0 to 140 deg. F)	N/A	Yes - IP54 Protection Class	> 50h backlight off, > 15h backlight on	Storage of 49,500 individual cover values
Elcometer								
	Elcometer P100 Imp	N/A	N/A	N/A	N/A	Unaffected by moisture and temperature changes	N/A	N/A
	Elcometer P120	Length: 515 mm; Shaft diameter: 16 mm	0.29 lbs (0.13 Kg)	N/A	N/A	N/A	N/A	N/A
	Elcometer P150	N/A	N/A	N/A	N/A	N/A	N/A	N/A
	Elcometer 331 Model B	9" x 5.1" x 4.9"	3.4 lbs (1.54 Kg)	N/A	up to 122 deg. F	Rugged waterproof case	32 hr, 20 hr if backlight is on; rechargeable in 4 hr	N/A
	Elcometer 331 Model BH	9" x 5.1" x 4.9"	3.4 lbs (1.54 Kg)	N/A	up to 122 deg. F	Rugged waterproof case	32 hr, 20 hr if backlight is on; rechargeable in 4 hr	N/A
	Elcometer 331 Model SH	9" x 5.1" x 4.9"	3.4 lbs (1.54 Kg)	N/A	up to 122 deg. F	Rugged waterproof case	32 hr, 20 hr if backlight is on; rechargeable in 4 hr	N/A
	Elcometer 331 Model TH	9" x 5.1" x 4.9"	3.4 lbs (1.54 Kg)	N/A	up to 122 deg. F	Rugged waterproof case	32 hr, 20 hr if backlight is on; rechargeable in 4 hr	N/A
	Elcometer 331 Model THD	9" x 5.1" x 4.9"	3.4 lbs (1.54 Kg)	N/A	up to 122 deg. F	Rugged waterproof case	32 hr, 20 hr if backlight is on; rechargeable in 4 hr	N/A

Table 3.3. Sizes and Features of Covermeter Devices Identified on the Market (Continued).

Manufacturers	Model	Dimensions	Weight	Operating Temperature	Storage Temperature	Water Resistance	Charge Time	Data Storage
Protoval								
	CM52	N/A	2 kg	N/A	N/A	N/A	13 hr minimum backlight off 14-16 hr recharge	N/A
	CM9	N/A	2 kg	N/A	N/A	N/A	8--12 hr min backlight off; 6--9 hr min backlight on; 14-16 hr recharge	N/A
Hilti								
	PS30 Ferrodetecter	9" x 4" x 1.75"	15 oz (420 g)	5 to 122 deg F	-15 to 150 deg F	Yes - IP54 Protection Class	10 hr battery life	N/A
	PS35 Ferrodetecter	9" x 4" x 1.75"	15 oz (420 g)	5 to 122 deg F	-15 to 150 deg F	Yes - IP54 Protection Class	8 hr battery life	N/A
	PS200 Ferrosan	Monitor: 10.4" x 2.2" x 6" Scanner: 10.3" x 5.2" x 5.2"	3.1 lb Monitor + 3.1 lb scanner	14 to 122 deg F	-5 to 140 deg F	Yes - IP54 Protection Class	8 hr battery life	9 Imagescans + up to 30 m of recorded Quickscan (max 10 scans)

Table 3.4. Performances of Covermeter Devices Identified on the Market.

Manufacturers	Model	Method	Orientation Detection	Depth	Position Accuracy	Diameter Measurements	Notes
Zircon							
	Multiscanner Pro SL	N/A	N/A	Up to 3" (76 mm) deep	Typically within 1/2" (13 mm) for metal studs	N/A	N/A
	Multiscanner i320 OneStep	N/A	N/A	Up to 3" (76 mm) deep rebar Up to 1.5" (38 mm) deep copper	Typically within 1/2" (13 mm) for metal studs using the dual scan and mark procedure	N/A	N/A
	Multiscanner i520 OneStep	N/A	N/A	Up to 3" (76 mm) deep rebar Up to 1.5" (38 mm) deep copper	Typically within 1/2" (13 mm) for metal studs using the dual scan and mark procedure	N/A	N/A
	MetalliScanner m40	N/A	N/A	Up to 4" (102 mm) deep 1/2" bar Up to 2" (51 mm) deep 1/2" copper	N/A	N/A	N/A
	MetalliScanner MT 6	N/A	N/A	Up to 6" (152 mm) deep ferrous and non-ferrous metal ± 1" (25 mm)	Center of #4 rebar or 1/2" (13 mm) copper pipe at a minimum grid spacing of 6" (152 mm) typically within 1/2" (13 mm)	N/A	<ul style="list-style-type: none"> • automatically differentiates between magnetic metal such as rebar and non-magnetic metal such as copper pipe; • shows the depth of metal from the surface in both inches and centimeters; • easy-to-read LCD screen pinpoints the location of metal objects to the nearest 0.5" (13 mm) and depth to the nearest in (25 mm)
Milwaukee							
	Sub-Scanner M12 Cordless Lithium-ion detection tool Kit 2290-21	N/A	N/A	Plastic: 3" Non-Ferrous Metal: 6" Ferrous Metal: 6"	Non-Ferrous Metal: 1/2" Ferrous Metal: 1/2" Position Accuracy Depth: 1/2"	N/A	<ul style="list-style-type: none"> • Displays metal depth; • Auto calibration
NDT James							
	Mini R-Meter	Magnetic and Electrical: Covermeter: Eddy-Current Meter	Yes	Up to 10" (No. 11 Bar) 250 mm (36 mm Bar)	N/A	N/A	<ul style="list-style-type: none"> • Capable of locating non-ferrous metals • Bar size calibration: 3/8" to 1-3/8" • Single sensor for all depth ranges
	R-Meter MK III	Magnetic and Electrical: Covermeter: Eddy-Current Meter	N/A	Up to 8" (200 mm) deep	N/A	Determine bar size up to 4.5" (115 mm) deep	<ul style="list-style-type: none"> • Capable of locating non-ferrous metals • Single sensor for all depth ranges

Table 3.4. Performances of Covermeter Devices Identified on the Market (Continued).

Manufacturers	Model	Method	Orientation Detection	Depth	Position Accuracy	Diameter Measurements	Notes
CCP							
	Fisher M-101	N/A	N/A	Typically 8-9" depth for 1/2" diameter rebar	Accuracy to 1/4" of the center line of the rebar	N/A	<ul style="list-style-type: none"> Sensitivity adjustment range: 12:1
Proceq							
	Profometer 5+ Model S	Electromagnetic - pulse induction Eddy Current method	Yes	Up to 3.94" (100 mm) small range Up to 7.28" (185 mm) large range for larger size bars	Cover Accuracy is +/- 2 mm or 5% depending on bar depth/size	Diameter measurement up to a cover of 70 mm (2.76 in)	Bar location, direction, cover depth & bar diameter estimations within range
	Profometer 5+ Model Scanlog	Electromagnetic - pulse induction Eddy Current method	Yes	Up to 3.94" (100 mm) small range Up to 7.28" (185 mm) large range for larger size bars	Cover Accuracy is +/- 2 mm or 5% depending on bar depth/size	Diameter measurement up to a cover of 70 mm (2.76 in)	<ul style="list-style-type: none"> 2-D display of rebar layout 2-D display and mapping of concrete cover values
	Profoscope	Electromagnetic - pulse induction Eddy Current method	Yes	Up to 3.94" (100 mm) small range Up to 7.28" (185 mm) large range for larger size bars	Cover Accuracy is +/- 2 mm or 5% depending on bar depth/size	Diameter measurement up to a cover of 70 mm (2.76")	<ul style="list-style-type: none"> Visual indication of rebars in close proximity Regional settings (metric, imperial) Identification of mid-point between rebars Start-up test kit allows user to familiarize himself with functions
	Profoscope+	Electromagnetic - pulse induction Eddy Current method	Yes	Up to 3.94" (100 mm) small range Up to 7.28" (185 mm) large range for larger size bars	Cover Accuracy is +/- 2 mm or 5% depending on bar depth/size	Diameter measurement up to a cover of 70 mm (2.76")	<ul style="list-style-type: none"> Visual indication of rebars in close proximity Regional settings (metric, imperial) Identification of mid-point between rebars Start-up test kit allows user to familiarize himself with functions Memory function for data acquisition

Table 3.4. Performances of Covermeter Devices Identified on the Market (Continued).

Manufacturers	Model	Method	Orientation Detection	Depth	Position Accuracy	Diameter Measurements	Notes
Elcometer							
	Elcometer P100 Imp	Magnetic and Electrical: Covermeter: Eddy-Current Meter	Yes	Up to 4.3" (110 mm)	N/A	Diameter measurement up to 1.25" (32 mm)	<ul style="list-style-type: none"> Mild steel and stainless steel galvanised wall ties with the optional Search Coil
	Elcometer P120	Magnetic and Electrical: Covermeter: Eddy-Current Meter	Yes	Up to 6.3" (160 mm)	N/A	Diameter measurement up to 1.25" (32 mm)	<ul style="list-style-type: none"> Resolution of parallel bars is 5.90" pitch at up to 3.35" (150 mm pitch at up to 85 mm) Reinforcement bar 20 mm (0.78") diameter to the side of the probe is 2.16" (55mm) and in front of the probe is 2.95" (75mm)
	Elcometer P150	Magnetic and Electrical: Covermeter: Eddy-Current Meter	N/A	N/A	N/A	N/A	N/A
	Elcometer 331 Model B	Magnetic and Electrical: Covermeter: Eddy-Current Meter	Yes	<ul style="list-style-type: none"> Narrow Pitch Search Head: from 8 mm to 80 mm for 40-mm bar size from 5 mm to 60 mm for 8-mm bar size Standard Search Head: from 15 mm to 95 mm for 40-mm bar size from 8 mm to 70 mm for 8-mm bar size Deep Cover Search Head: from 35 mm to 180 mm for 40-mm bar size from 25 mm to 160 mm for 8-mm bar size Borehole Probe: reinforcement bar up to 60 mm 	N/A	<ul style="list-style-type: none"> Metric: 5-50 bar diam in 21 values US Bar Numbers: #2-#18 bar sizes in 18 values ASTM/Canadian: 10-55M bar diam in 8 values Japanese: 6 - 57mm bar diam in 16 values 	<ul style="list-style-type: none"> Narrow Head: measures the cover thickness when the gaps between each of the rebar are close together Standard Head: designed for most of the measurement requirements Deep Cover Head: accurately measures rebars that are deep within the structure Borehole Probe: locate multiple layers of rebar lying deep within the concrete
	Elcometer 331 Model BH	Magnetic and Electrical: Covermeter: Eddy-Current Meter	Yes	<ul style="list-style-type: none"> Narrow Pitch Search Head: from 8 mm to 80 mm for 40-mm bar size from 5 mm to 60 mm for 8-mm bar size Standard Search Head: from 15 mm to 95 mm for 40-mm bar size from 8 mm to 70 mm for 8-mm bar size Deep Cover Search Head: from 35 mm to 180 mm for 40-mm bar size from 25 mm to 160 mm for 8-mm bar size Borehole Probe: reinforcement bar up to 60 mm 	N/A	<ul style="list-style-type: none"> Metric: 5-50 bar diam in 21 values US Bar Numbers: #2-#18 bar sizes in 18 values ASTM/Canadian: 10-55M bar diam in 8 values Japanese: 6 - 57mm bar diam in 16 values 	<ul style="list-style-type: none"> Narrow Head: measures the cover thickness when the gaps between each of the rebar are close together Standard Head: designed for most of the measurement requirements Deep Cover Head: accurately measures rebars that are deep within the structure Borehole Probe: locate multiple layers of rebar lying deep within the concrete

Table 3.4. Performances of Covermeter Devices Identified on the Market (Continued).

Manufacturers	Model	Method	Orientation Detection	Depth	Position Accuracy	Diameter Measurements	Notes
Elcometer							
	Elcometer 331 Model SH	Magnetic and Electrical: Covermeter: Eddy-Current Meter	Yes	<ul style="list-style-type: none"> • Narrow Pitch Search Head: from 8 mm to 80 mm for 40-mm bar size from 5 mm to 60 mm for 8-mm bar size • Standard Search Head: from 15 mm to 95 mm for 40-mm bar size from 8 mm to 70 mm for 8-mm bar size • Deep Cover Search Head: from 35 mm to 180 mm for 40-mm bar size from 25 mm to 160 mm for 8-mm bar size • Borehole Probe: reinforcement bar up to 60 mm 	N/A	<ul style="list-style-type: none"> • Metric: 5-50 bar diam in 21 values • US Bar Numbers: #2 - #18 bar sizes in 18 values • ASTM/Canadian: 10 - 55M bar diam in 8 values • Japanese: 6 - 57mm bar diam in 16 values 	<ul style="list-style-type: none"> • Narrow Head: measures the cover thickness when the gaps between each of the rebar are close together • Standard Head: designed for most of the measurement requirements • Deep Cover Head: accurately measures rebars that are deep within the structure • Borehole Probe: locate multiple layers of rebar lying deep within the concrete
	Elcometer 331 Model TH	Magnetic and Electrical: Covermeter: Eddy-Current Meter	Yes	<ul style="list-style-type: none"> • Narrow Pitch Search Head: from 8 mm to 80 mm for 40-mm bar size from 5 mm to 60 mm for 8-mm bar size • Standard Search Head: from 15 mm to 95 mm for 40-mm bar size from 8 mm to 70 mm for 8-mm bar size • Deep Cover Search Head: from 35 mm to 180 mm for 40-mm bar size from 25 mm to 160 mm for 8-mm bar size • Borehole Probe: reinforcement bar up to 60 mm 	N/A	<ul style="list-style-type: none"> • Metric: 5-50 bar diam in 21 values • US Bar Numbers: #2 - #18 bar sizes in 18 values • ASTM/Canadian: 10 - 55M bar diam in 8 values • Japanese: 6 - 57mm bar diam in 16 values 	<ul style="list-style-type: none"> • Narrow Head: measures the cover thickness when the gaps between each of the rebar are close together • Standard Head: designed for most of the measurement requirements • Deep Cover Head: accurately measures rebars that are deep within the structure • Borehole Probe: locate multiple layers of rebar lying deep within the concrete
	Elcometer 331 Model THD	Magnetic and Electrical: Covermeter: Eddy-Current Meter	Yes	<ul style="list-style-type: none"> • Narrow Pitch Search Head: from 8 mm to 80 mm for 40-mm bar size from 5 mm to 60 mm for 8-mm bar size • Standard Search Head: from 15 mm to 95 mm for 40-mm bar size from 8 mm to 70 mm for 8-mm bar size • Deep Cover Search Head: from 35 mm to 180 mm for 40-mm bar size from 25 mm to 160 mm for 8-mm bar size • Borehole Probe: reinforcement bar up to 60 mm 	N/A	<ul style="list-style-type: none"> • Metric: 5-50 bar diam in 21 values • US Bar Numbers: #2 - #18 bar sizes in 18 values • ASTM/Canadian: 10 - 55M bar diam in 8 values • Japanese: 6 - 57mm bar diam in 16 values 	<ul style="list-style-type: none"> • Narrow Head: measures the cover thickness when the gaps between each of the rebar are close together • Standard Head: designed for most of the measurement requirements • Deep Cover Head: accurately measures rebars that are deep within the structure • Borehole Probe: locate multiple layers of rebar lying deep within the concrete

Table 3.4. Performances of Covermeter Devices Identified on the Market (Continued).

Manufacturers	Model	Method	Orientation Detection	Depth	Position Accuracy	Diameter Measurements	Notes
Protoval							
	CM52	Magnetic and Electrical: Covermeter	N/A	<ul style="list-style-type: none"> • Standard Head Cover Range for 40-mm diam bar is 25--100 mm • Standard Head Cover Range for 8-mm diam bar is 25--100 mm • Midget Head Cover Range is 6--50 mm 	<ul style="list-style-type: none"> • Standard Head up to 65 mm is ± 2 mm • Standard Head 70 mm and over is ± 3 mm • Midget Head is ± 1 mm from 10mm to 30mm 	From 5 to 40 mm diam (11 values)	<ul style="list-style-type: none"> • Measure up to less than 60 mm separation between bars
	CM9	Magnetic and Electrical: Covermeter	N/A	<ul style="list-style-type: none"> • Standard Head Cover Range for 40-mm diam bar is 15--95 mm • Standard Head Cover Range for 8-mm diam bar is 5--70 mm • Large Head Cover Range for 40-mm diam bar is 180 mm • Large Head Cover Range for 8-mm diam bar is 20 mm 	<ul style="list-style-type: none"> • Standard Head up to 65 mm is ± 2 mm max • Standard Head 70 mm and over is $\pm 5\%$ 	From 5 to 50 mm diam (21 values)	<ul style="list-style-type: none"> • Measure up to less than 60 mm separation between bars
Hilti							
	PS30 Ferrodetecter	Magnetic and Electrical	Point Detection	4-3/4" at > #3 rebar diam (120 mm)	3/8 in (± 10 mm)	N/A	N/A
	PS35 Ferrodetecter	Magnetic and Electrical	Point Detection	4-3/4" at > #3 rebar diam (120 mm)	3/8 in (± 10 mm)	N/A	N/A
	PS200 Ferrosan	Magnetic and Electrical	Up to 45 deg.	Max depth for determining depth of coverage is 5.9" (at #11 rebar diam) Max depth for determining rebar diameter is 2.4"	Depth of coverage is $\pm 10\%$ typical when the ratio of spacing to depth of coverage $\geq 2:1$	Yes	N/A

Table 3.5. Sizes and Features of GPR Devices Identified on the Market.

Manufacturer	Model	Dimensions	Weight	Operating Temperature	Water Resistance	Battery Life	Data Storage
GSSI	StructureScan Optical	SIR-3000: 1.4" x 8.7" x 4.1" Antenna: 1.5" x 3.9" x 6.5"	SIR-3000: 9 lbs Antenna: 4 lbs	50 to 104° F	Yes	3 hrs	2 GB internal memory
	StructureScan Standard	SIR-3000: 1.4" x 8.7" x 4.1" Antenna: 1.5" x 3.9" x 6.5"	SIR-3000: 9 lbs Antenna: 4 lbs	50 to 104° F	Yes	3 hrs	2 GB internal memory
	StructureScan Mini	6" x 7" x 9"	3.3 lbs	50 to 104° F	Yes	3 hrs	1 GB internal 2 GB SD card
	StructureScan Mini HR	6" x 7" x 9"	3.3 lbs	50 to 104° F	Yes	3 hrs	1 GB internal 2 GB SD card
Hilti Corporation (Distributed in the US by Hilti USA)	PS1000 X-Scan	12.5" x 5.6" x 7.5"	5.4 lbs	5 to 122° F	Yes - IP54	4 hrs	N/A
JRC (Distributed in the US by Proceq)	Handy Search	5.86" x 5.78" x 8.50"	2.6 lbs	32 to 122° F	Splashproof	1.5 hrs	~ 200 passes (49.2 ft) search data saved in binary format when using 1-GB memory
IDS (Distributed in the US by Olson Instruments, Inc.)	Aladdin System	4.8" x 4.8" x 7.25"	4.4 lbs	Panasonic Toughbook - 10 to +140 degrees F	IP65 - Ingress Protection total protection against dust and protection against low pressure water jets from any direction - limited ingress permitted	8 hrs Aladdin, 7 hours Panasonic Toughbook Notebook PC	40 GB plus depending on harddrive of Toughbook

Table 3.6. Performances of GPR Devices Identified on the Market.

Manufacturer	Model	Orientation Detection	Depth	Position Accuracy	Diameter Measurements	Notes
GSSI	StructureScan Optical	Parallel & Perpendicular	1000 MHz Antenna: to 24" 1600 MHz antenna: to 16" 2600 MHz HR antenna: to 12" 2000 MHz Palm Antenna: to 12"	Depth resolution: 0.04" (1mm) Pitch: 0.03" (0.8mm)	No	N/A
	StructureScan Standard	Parallel & Perpendicular	1000 MHz Antenna: to 24" 1600 MHz antenna: to 16" 2600 MHz HR antenna: to 12" 2000 MHz Palm Antenna: to 12"	Depth resolution: 0.04" (1mm) Pitch: 0.03" (0.8mm)	No	N/A
	StructureScan Mini	Parallel & Perpendicular	1600 MHz General Purpose Antenna: to 20"	Depth resolution: 0.04" (1mm) Pitch: 0.03" (0.8mm)	No	N/A
	StructureScan Mini HR	Parallel & Perpendicular	2600 MHz High Resolution Antenna: to 16"	Depth resolution: 0.04" (1mm) Pitch: 0.03" (0.8mm)	No	N/A
Hilti Corporation (Distributed in the US by Hilti USA)	PS1000 X-Scan	Up to 45 deg.	12"	Localization accuracy: $\pm 0.5"$; Accuracy of depth indication: $<4"$: $\pm 0.5"$; $>4"$: $\pm 15\%$ "	N/A	N/A
JRC (Distributed in the US by Proceq)	Handy Search	N/A	11.81" when bar diameter is 0.23" or greater	Resolution of covering depth: Shallow mode: $\sim 0.04"$ (1mm) Deep mode: $\sim 0.08"$ (2mm)	N/A	N/A
IDS (Distributed in the US by Olson Instruments, Inc.)	Aladdin System	2 - 2GHz bowtie antenna pairs for V-V, H-H and H-V, V-H (2 orthogonal and 2 angled antenna pair combinations)	~ 2 ft (60 cm) in dry, mature concrete	Precise 3-D Images with Pad Survey Guide kit with 1.58 cm between parallel scans using every other groove in the Aladdin "carpet" and GRED 3D software to provide mm level accuracy in 3.3 x 6.6 ft (1 x 2 m) PSG scan	Possible for crossing bars to get the size of the top bar by comparing the radar reflection depth of the top bar to the bar immediately below it.	Ethernet LAN cable and wireless WiFi connection of DAD Fastwave Control Unit to Panasonic Toughbook.

The researchers contacted the Companies identified in Tables 3.3 to 3.5 to request their participation in this research study. The following Companies responded and agreed to participate (reported in no particular order):

- ❖ *Geophysical Survey Systems, Inc. (GSSI)* lent GPR device "**SS MiniHR unit**";
- ❖ *Hilti*, lent GPR device "**PS1000 X-Scan**" and Covermeter device "**PS200 Ferrosan**";
- ❖ *Japan Radio Co. (JRC)* lent GPR device "**Handy Search**";
- ❖ *Proceq*, lent Covermeter devices "**Profoscope⁺**" and "**Profometer^{®5+}**";
- ❖ *Olson Instruments, Inc.*, lent GPR device "**Aladdin System**".

The GPR device "Handy Search" is manufactured by Japan Radio Co. (JRC) (Japan) and distributed in the USA and Canada by Proceq USA. The GPR device "Aladdin System" is manufactured by Ingegneria dei Sistemi of Pisa (Italy) (IDS Georadar Division) and distributed in the USA by Olson Instruments, Inc.. For simplicity, the researchers will refer to IDS Georadar Division as IDS.

These Companies lent their Covermeter and/or GPR devices to the Roadside Safety & Physical Security Division at TTI for the time needed to perform the necessary testing aimed at evaluating and comparing the performance of the different technologies as for locating steel rebars in concrete slabs.

CHAPTER 4. REINFORCED CONCRETE SLABS TESTING

A total of five reinforced concrete specimens were built at the Roadside Safety & Physical Security Division at TTI for testing the capabilities of the rebar locator devices reviewed. The researchers designed the specimens with the scope of replicating the requirements of Louisiana DOT concrete bridge deck systems, as for rebar sizes, spacing and other details (Appendix B). All five specimen were built at the same time and were tested when the concrete was 3 months cured.

CONCRETE SPECIMENS DESIGN

After discussing the design details with Louisiana DOT, specimen characteristics were chosen as follow:

- Reinforced specimens are 8 ft long and 3 ft wide;
- Total height of the decks varies to allow for different rebar concrete coverage depth. Heights chosen are 7 (1 specimen), 8 (2 specimens) and 9.5 inches (2 specimens);
- There are a total of two 8-inch high decks: one of them has a 2-inch asphalt on the top (also referred to as a 10-inch thick specimen), to evaluate the devices capability to detect reinforcement with and without overlay of asphalt on top of the deck;
- Two rebar layers are included in each specimen: a first (top) layer, with 2 inches concrete coverage from the top and a second (bottom) layer with 1 inch concrete coverage from the bottom;
- Longitudinal rebars are No. 4 and 5 (top and bottom); transverse rebars are No. 5 and 6 (top and bottom); ONLY for one of the 9.5-inch high deck, longitudinal bars No. 8 and 9 were chosen;
- Spacing between longitudinal rebars varies between 8 and 11 inches; spacing between transverse rebars varies between 5 and 6.5 inches;
- Each specimen includes 18 inch of transverse rebar lap splices;
- Concrete blocks were tested supported by the ground and elevated off the ground.

Although for Louisiana DOT concrete bridge deck systems using a longitudinal girder system, the main reinforcing steel is transverse to the traffic and the reinforcing steel is generally no. 6 or 7 bars top and bottom, use of transverse bars sizes no. 5 and 6 might be more common in other States. Researchers decided to use transverse bars sizes no. 5 and 6, arguing that if the tested device is able to detect smaller diameter bars (no. 5 and no. 6), then they would feel comfortable about its ability of detecting bigger size bars (no. 6 and no.7).

At least one concrete specimen should be tested when both lying on the ground and when elevated from ground. This would allow considering any effects that testing of the slab would have with the slab sections elevated off the ground, since this is the typical configuration for a bridge deck. Figure 4.1 reports the detailed drawings for the concrete specimens. Pictures of exemplar concrete specimens are reported in Figure 4.2 ((a) without asphalt coverage on top and (b) with 2-inch asphalt coverage).

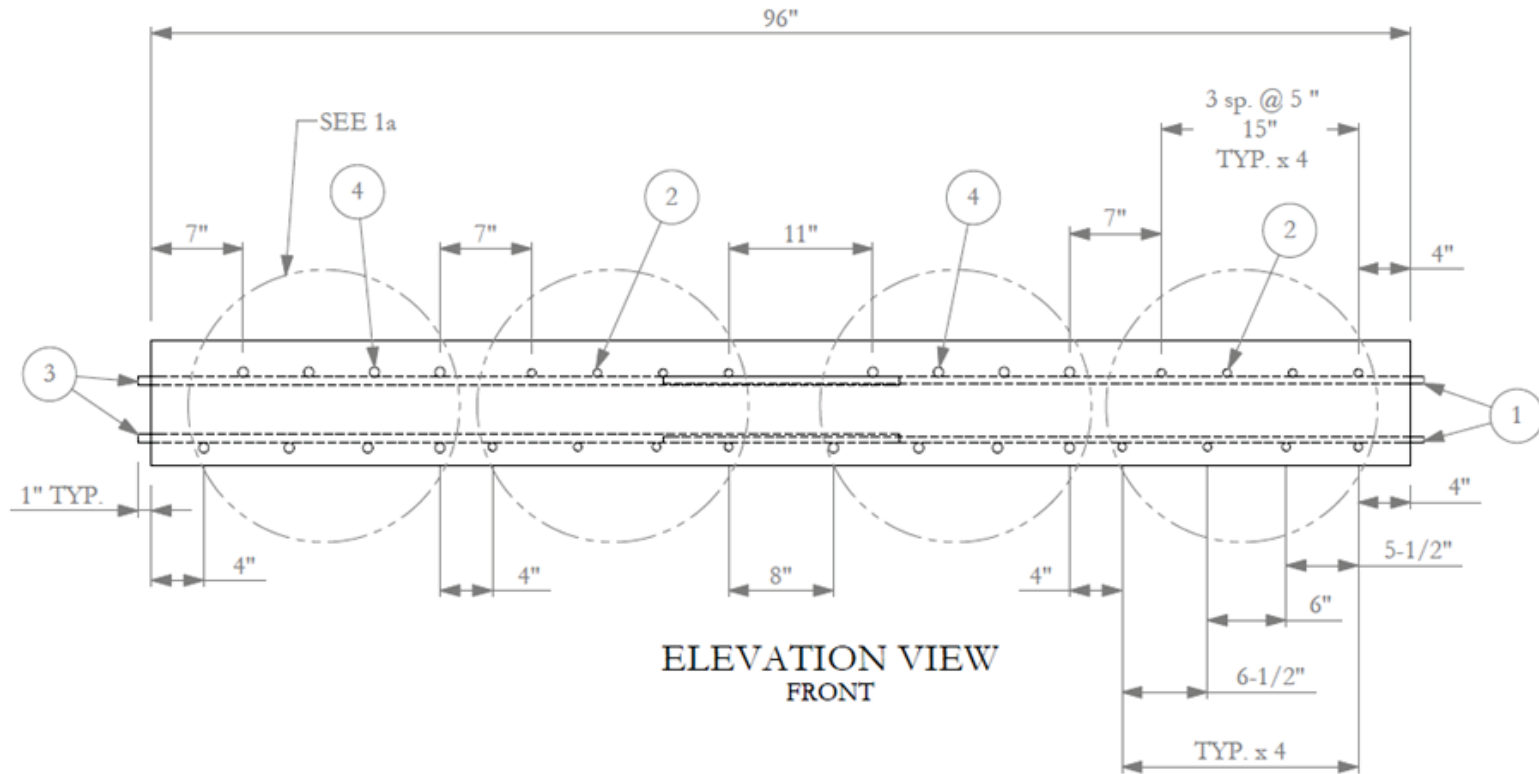

ELEVATION VIEW
FRONT

#	PART NAME	QTY.
1	Rebar, #4 x 58"	9
2	Rebar, #5 x 38"	16
3	Rebar, #5 x 58"	9
4	Rebar, #6 x 38"	16

1a. Transverse bars (2) and (4) are the same within each circle.

Texas Transportation Institute		The Texas A&M University System College Station, Texas 77843	
Project	405160-32	Rebar Locating	
Drawn By	GES	Scale	1:12
Sheet		1 of 3	
Front View			
Approved:	Chiara Silvestri	Signature:	<i>[Signature]</i>
Date:	2011-10-13		

Figure 4.1. Reinforced Concrete Specimens.

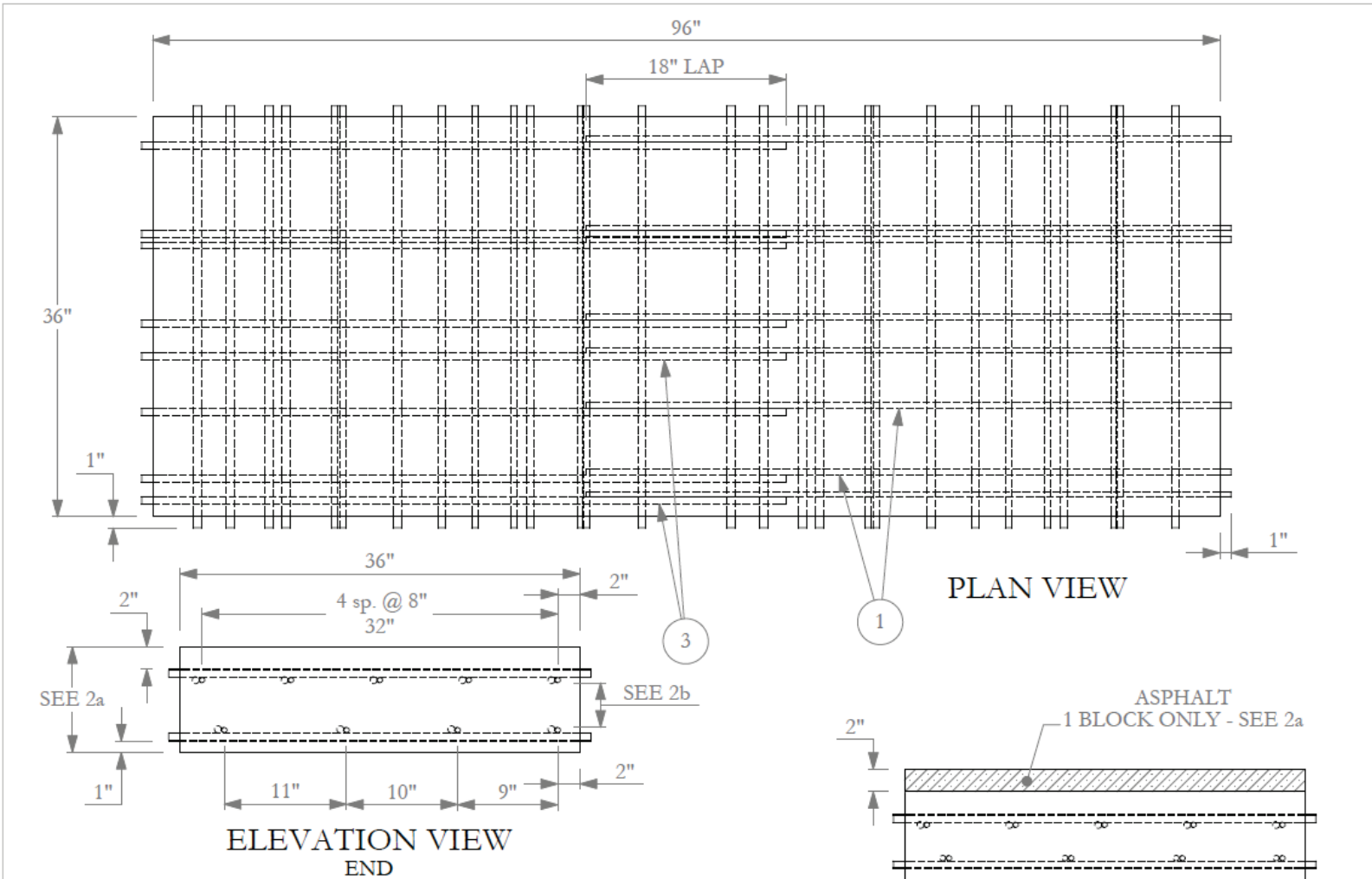

2a. Build 5 blocks, one at 7", two at 9-1/2", and two at 8" thick. Place asphalt 2" thick on top of one of the 8" thick blocks. Dimensions and rebar are identical for the 7" block, both 8" blocks, and one 9-1/2" thick block. See next sheet for details for the second 9-1/2" block.

2b. Spacing between #5 longitudinal bars (clear space, not ϕ 's) is 3-3/4" on the 9-1/2" slab, 2-1/4" on the 8" slab, and 1-1/4" on the 7" thick slab.

Texas Transportation Institute		The Texas A&M University System College Station, Texas 77843	
Project	405160-32	Rebar Locating	
Drawn By	GES	Scale	1:12
Sheet	2 of 3	Plan and End View	

Figure 4.1. Reinforced Concrete Specimens (Continued).

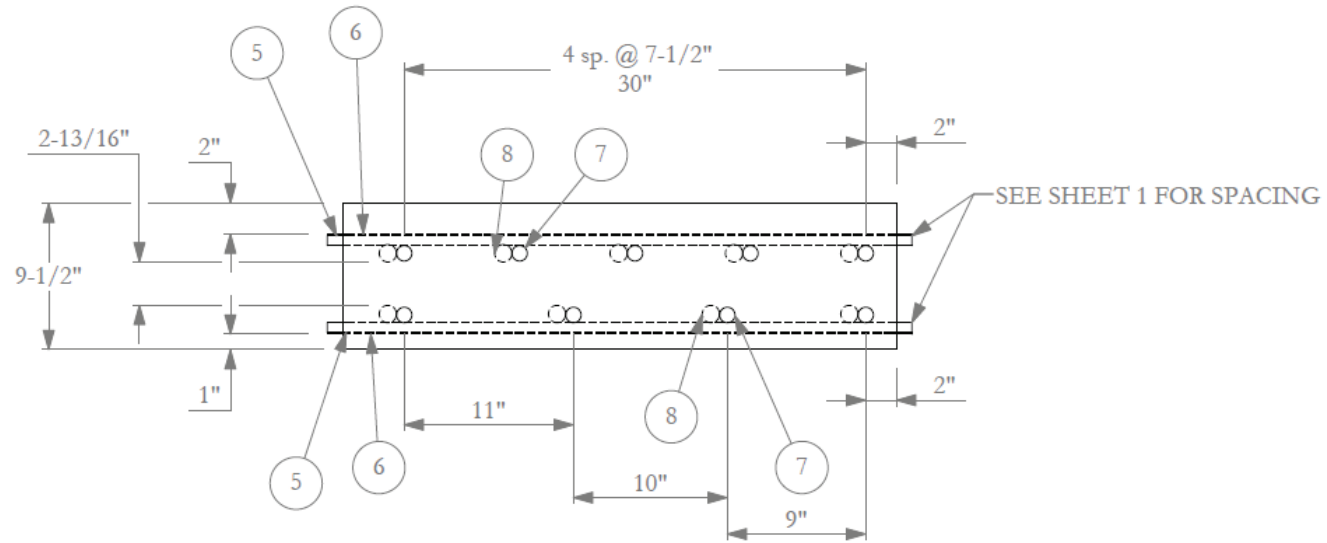

#	PART NAME	QTY.
5	Rebar, #5 x 38"	16
6	Rebar, #6 x 38"	16
7	Rebar, #8 x 58"	9
8	Rebar, #9 x 58"	9

3a. See sheets 1 and 2 for all dimensions not shown here.

Texas Transportation Institute		The Texas A&M University System College Station, Texas 77843	
Project	405160-32	Rebar Locating	
Drawn By	GES	Scale	1:10
Sheet	3 of 3	Large Rebar Slab	

Figure 4.1. Reinforced Concrete Specimens (Continued).

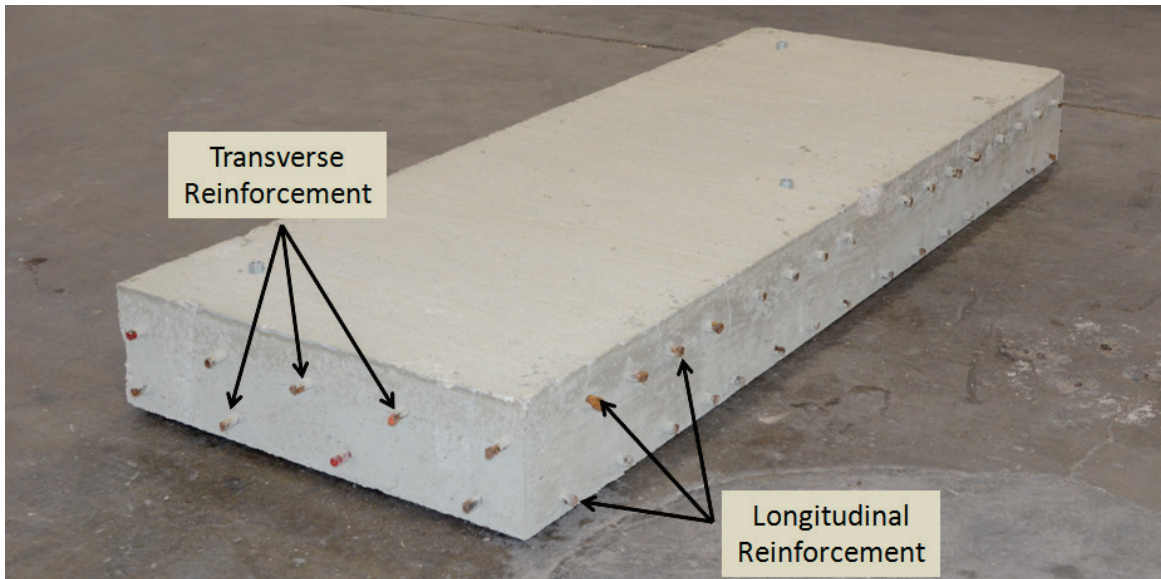

(a) Without asphalt cover on top

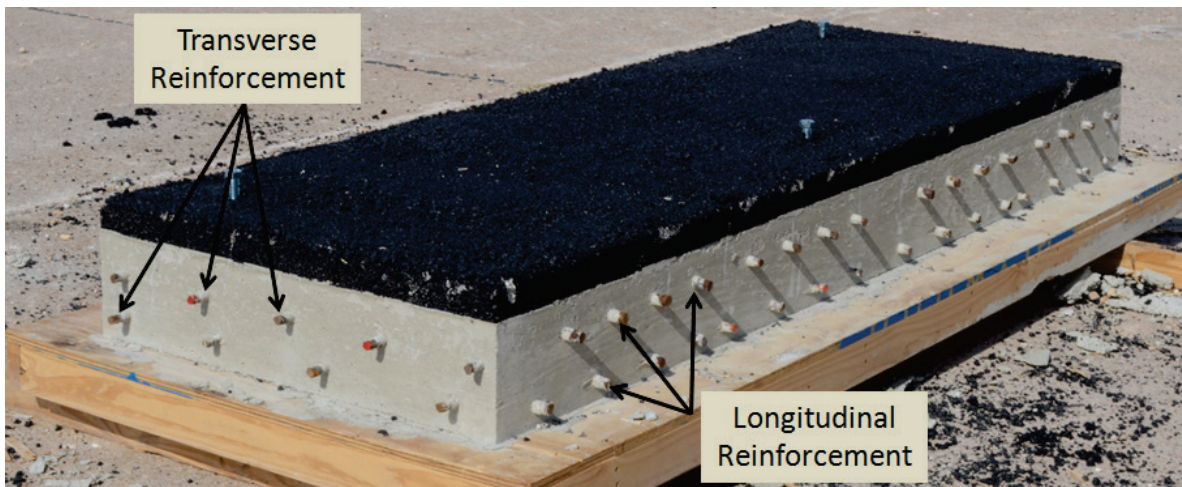

(b) Covered with 2 inches of asphalt on the top

Figure 4.2. Photographs of Reinforced Concrete Specimen Examples.

Detailed testing plans for both covermeter and GPR devices rebar locator capabilities evaluation follows.

Testing Plan for Rebar Location with Covermeters

Devices Tested:.....Cover Meters

Total Specimens to Be Tested:..5

Scope of the Test:.....1) Locate **First** Layer of Longitudinal and Transverse Rebars (for each rebar, identify the distance from a specimen corner which is considered a reference point)
.....2) Identify Rebar Concrete Coverage (inches)
.....3) Identify Size of Rebar (if feasible)

Directions for Test Completion

- 1) Each concrete specimen side is partially covered with papers to allow marking of the rebar position with respect to a specimen corner taken as a reference point;
- 2) Rebar extending beyond the concrete are covered;
- 3) Test is fully completed on a reinforced concrete specimen before starting another test on the next specimen;
- 4) All specimens are tested when **laying on ground**;
- 5) Transverse rebars are identified:
 - 5-a) Their positions are marked on the papers with a marker. In addition, record of their position is reported on a paper;
 - 5-b) For each rebar identified, if feasible, the concrete coverage is read and the value reported on a paper;
 - 5-c) For each rebar detected, if feasible, the size is identified;
- 6) Longitudinal rebars are identified:
 - 6-a) Their positions are marked on the papers with a marker. In addition, record of their position is reported on a paper;
 - 6-b) For each rebar identified, if feasible, the concrete coverage is read and the value reported on a paper;
 - 6-c) For each rebar detected, if feasible, the size is identified;

Testing Plan for Rebar Location with Ground Penetrating Radars

Devices Tested:.....Ground Penetrating Radar (GPR)

Total Specimens to Be Tested:...5

Scope of the Test:.....1) Locate **First and Second** Layer of Longitudinal and Transverse Rebars (for each rebar, identify the distance from a specimen corner which is considered a reference point)
.....2) Identify Rebar Concrete Coverage (inches)
.....3) Identify Size of Rebar (if feasible)

Directions for Test Completion

- 1) Each concrete specimen side is partially covered with papers to allow marking of the rebar position with respect to a specimen corner taken as a reference point;
- 2) Rebar extending beyond the concrete are covered;
- 3) Test is to be fully completed on a reinforced concrete specimen before starting another test on the next specimen;

PART I:

- 4) All specimens are tested when **laying on ground**;
- 5) Transverse rebars are identified, in the FIRST layer:
 - 5-a) Their positions are marked on the papers with a marker. In addition, record of their position is reported on a paper;
 - 5-b) For each rebar identified, if feasible, the concrete coverage is read and the value reported on a paper;
 - 5-c) For each rebar detected, if feasible, the size is identified;
- 6) Longitudinal rebars are identified, in the FIRST layer:
 - 6-a) Their positions are marked on the papers with a marker. In addition, record of their position is reported on a paper;
 - 6-b) For each rebar identified, if feasible, the concrete coverage is read and the value reported on a paper;
 - 6-c) For each rebar detected, if feasible, the size is identified;

PART II:

- 7) All specimens are tested when **laying on ground**;
- 8) Transverse rebars are identified, in the SECOND layer:

- 8-a) Their positions are marked on the papers with a marker. In addition, record of their position is reported on a paper;
- 8-b) For each rebar identified, if feasible, the concrete coverage is read and the value reported on a paper;
- 8-c) For each rebar detected, if feasible, the size is identified;
- 9) Longitudinal rebars are identified, in the SECOND layer:
 - 9-a) Their positions are marked on the papers with a marker. In addition, record of their position is reported on a paper;
 - 9-b) For each rebar identified, if feasible, the concrete coverage is read and the value reported on a paper;
 - 9-c) For each rebar detected, if feasible, the size is identified;
- 10) Specimens are tested when elevated from ground.

Due to the water content in concrete, GPR technology can be influenced by concrete curing time. As a consequence, TTI researchers decided to perform the testing when the concrete reinforced specimens were three months old. A curing time of three months is considered sufficient for obtaining reliable results using GPR devices. Generally, completion of specimen testing by each Company required an entire work-day and proper results collection was accomplished on the following day.

GPR devices were shipped to the TTI facility prior to the testing date or were brought by the Company representative on the day of the testing. Any needed device settings were defined by the Company representative the day of the testing. Specimens scanning, device results reading and reporting were entirely conducted by each Company representative. TTI researchers were limited to supervise that the defined specimens testing plan was followed correctly. GPR technique, in fact, requires training to be completed by the user to insure appropriate setting definition, proper usage of the device and correct interpretation of the reported information. Since TTI researchers did not receive formal training about GPR technique and GPR data interpretation, usage of these devices was entirely assigned to the Company representatives to avoid any device misuse and/or collected results misinterpretation.

The rebar locations marked on the specimen papers were measured with use of a calibrated ruler starting from the previously defined reference point. When time allowed, the measurements were taken by TTI and the Company representatives together, on the same day of the testing. In other cases, the TTI representative alone collected the reported rebar positions the day following the test. As for the concrete coverage results, measurements were read and reported to the TTI researchers by the Company representative.

Specimen testing was performed in a controlled laboratory environment at a TTI facility. TTI researchers did not consider any possible weather and temperature influence on the devices performance. The authors caution that testing of the same specimens may result in different outcomes when using the selected devices in a different environment.

After inquiring State DOTs on the concrete aggregate type normally used for bridge mixes, Class A and C aggregates were chosen for the reinforced specimens. TTI researchers did not consider possible influence of different aggregate Classes on the GPR devices performance.

After performing the concrete specimens scanning on site (at TTI facility), the Companies representatives re-evaluated the data collected in their offices. Scanned data were post-processed and revised results were sent back to the TTI representative. On-site and post-processed data are reported in the next chapter.

In order to evaluate possible concrete curing effects on the performance of the GPR devices, an additional study was included with this particular scope. Testing plan, specimen constructions and test results are reported in Appendix C.

CHAPTER 5. RESULTS

This Chapter reports the results obtained from scanning the concrete specimens, in terms of rebar locator capability of different devices considered. First, the results from GPR devices use are presented. Next, results from covermeter devices use are reported.

GROUND PENETRATING RADAR RESULTS

For each GPR device employed, rebar locations identified with use of the device are reported as "on site" and as "post-processed".

GSSI Results

On-Site Rebars GSSI Detection

The locations of the rebars detected in real-time were identified by the centers of their reflection hyperbolas. After a full hyperbola appeared on the screen of the SS MiniHR unit, the user backed the unit up, which moved a vertical position cursor over the data. The position of the vertical cursor on the data matched the position of the lasers on the side of the unit. So, when the vertical cursor was positioned over the data was on the top of a hyperbola, the lasers indicated the position of the rebar. This is how rebars were located in real-time. Figure 5.1 shows typical screen of data with a vertical cursor positioned over the tops of shallow and deep rebars, respectively. More details on the characteristics and use of the GSSI GPR device are reported in Appendix D.

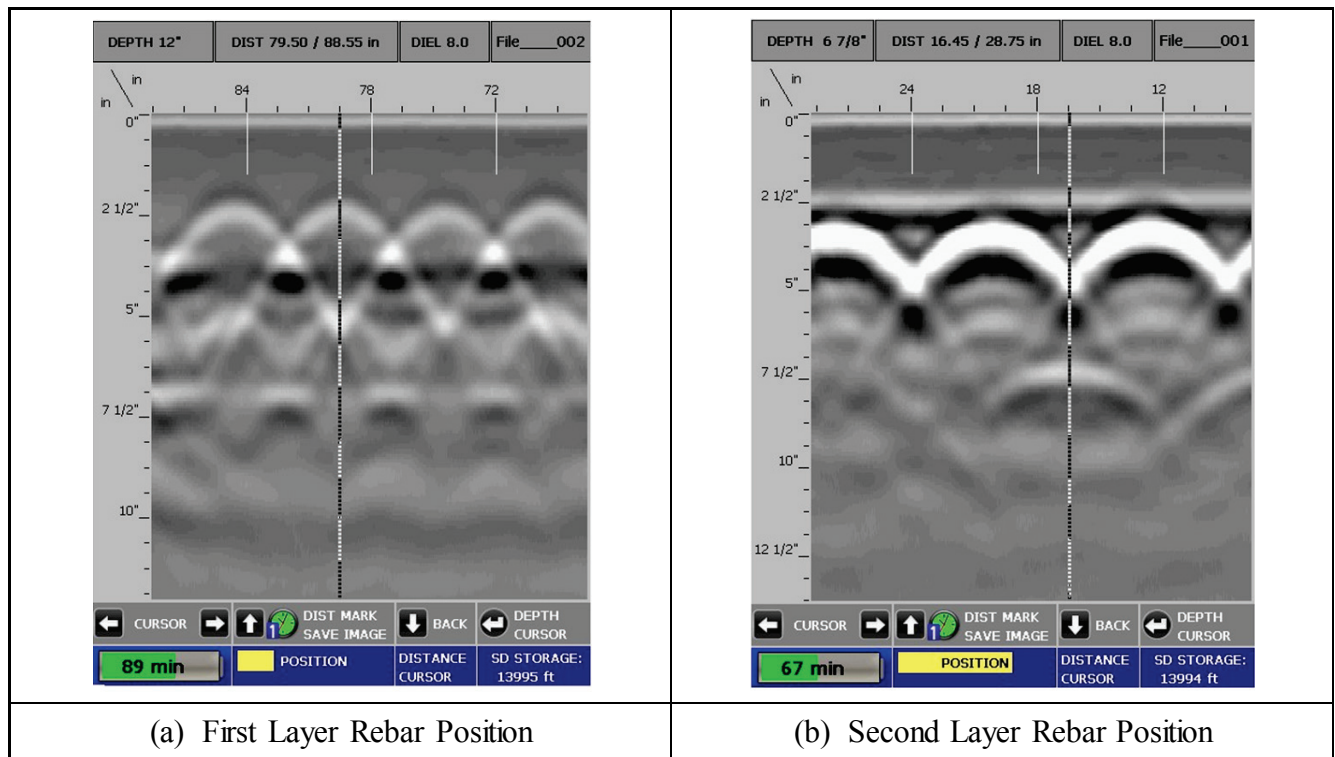
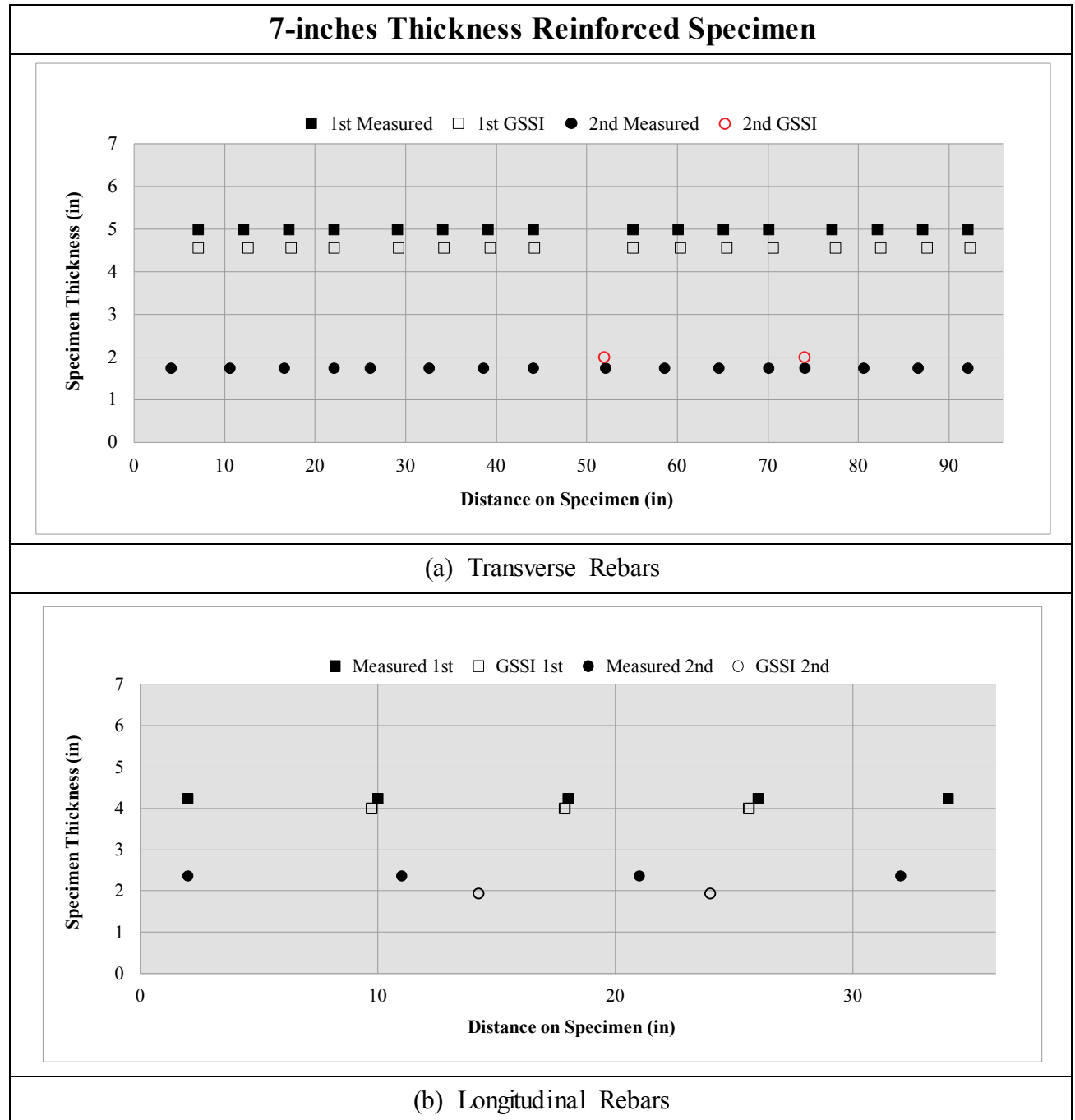

Figure 5.1. Data Collection Screen Showing Vertical Cursor Positioned Over Center of (a) First Layer and (b) Second Layer Rebar.

Figures 5.2 to 5.8 show the results obtained from the reinforced concrete specimens scanning with the SS MiniHR Unit from GSSI. Each figure reports the measured exact position of the steel reinforcement of the first and second layer in each slab. Also, the rebars positions determined by the GPR device from GSSI on site measurements are illustrated for an effective comparison of the exact and estimated steel locations.



*Red measurements are referred to rebar positions for which it was not reported concrete coverage.

Figure 5.2. GSSI On-Site Results for 7 inches Thickness Reinforced Specimen.

8-inches Thickness Reinforced Specimen

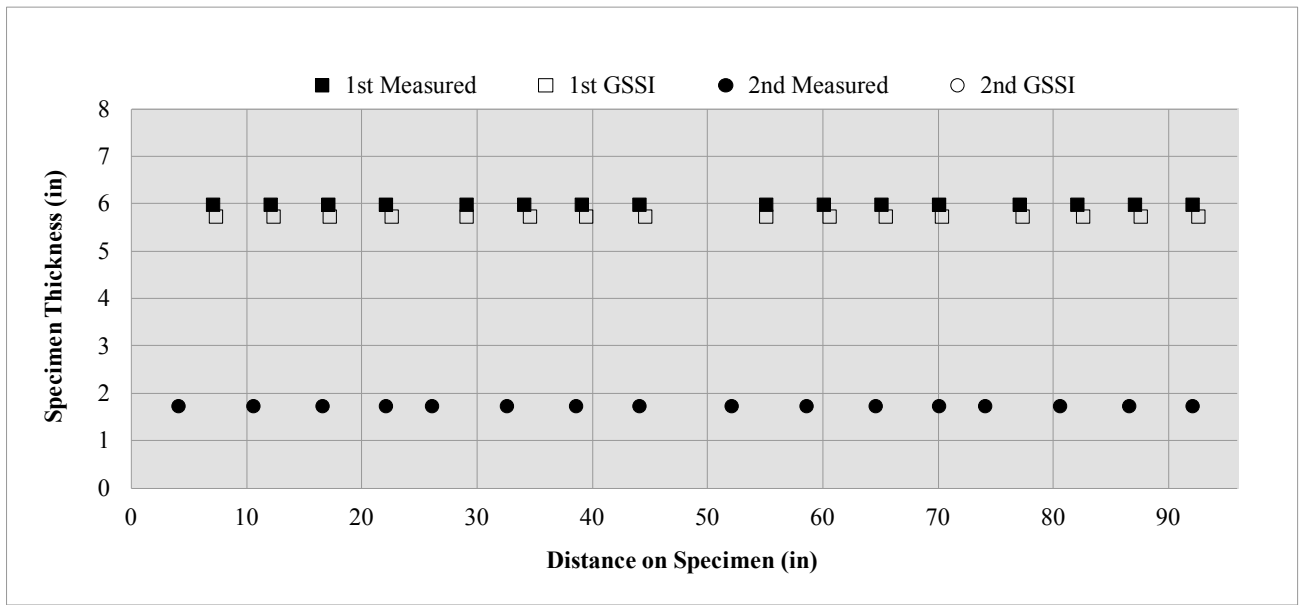

(a) Transverse Rebars

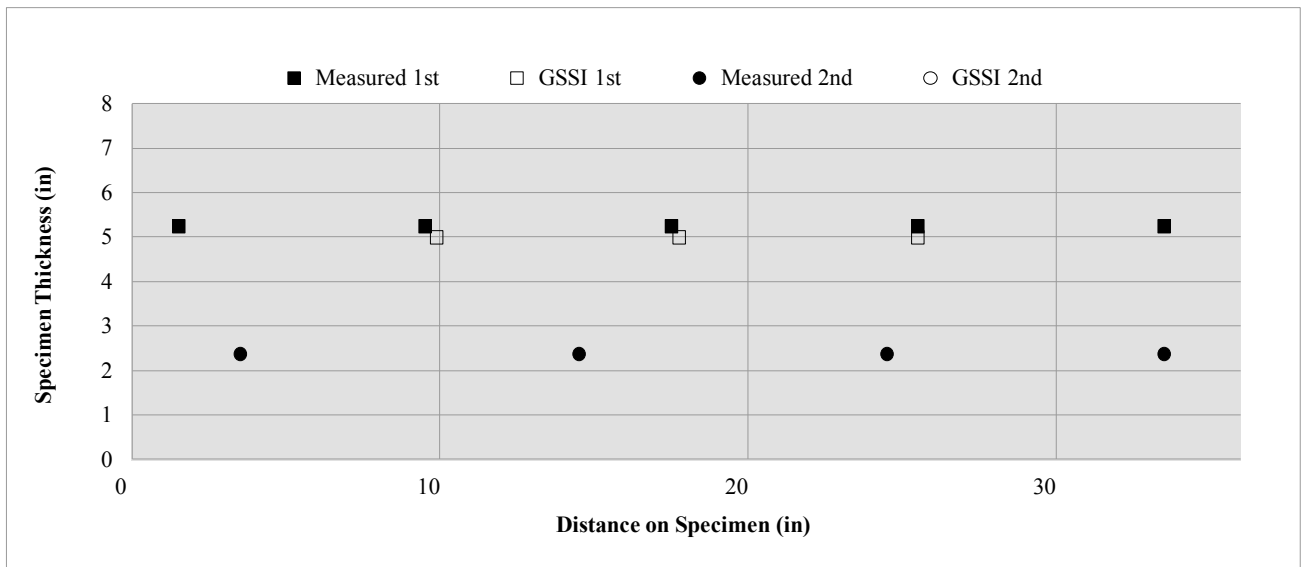

(b) Longitudinal Rebars

Figure 5.3. GSSI On-Site Results for 8 inches Thickness Reinforced Specimen.

8-inches Thickness Reinforced Specimen Elevated

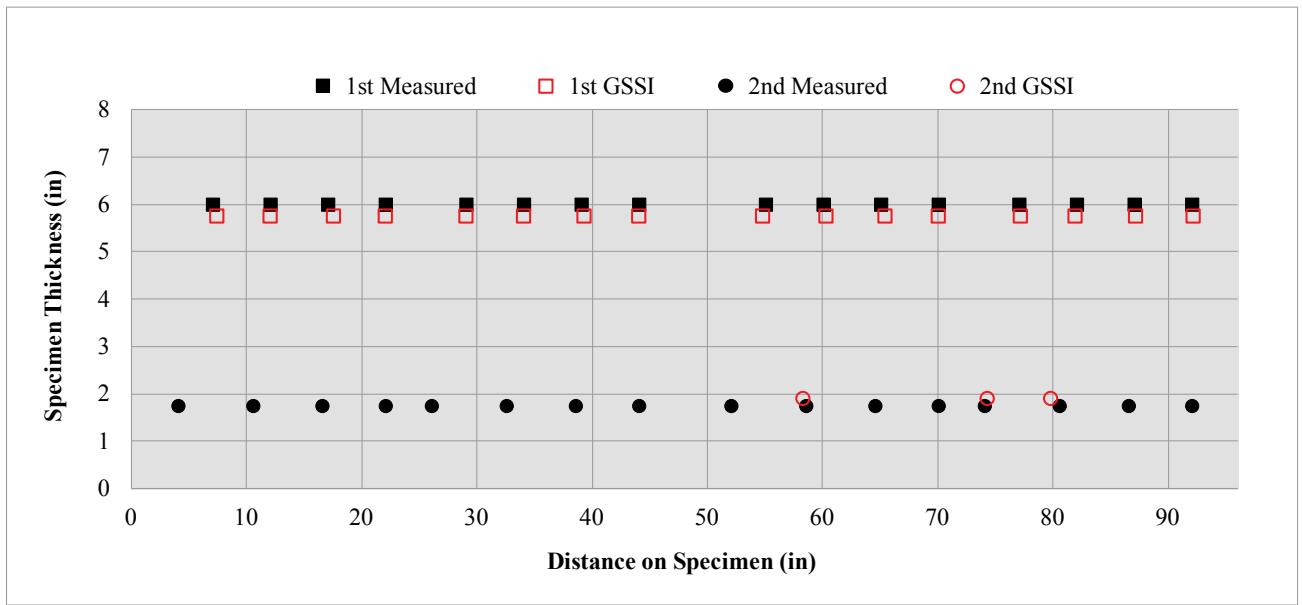

(a) Transverse Rebars

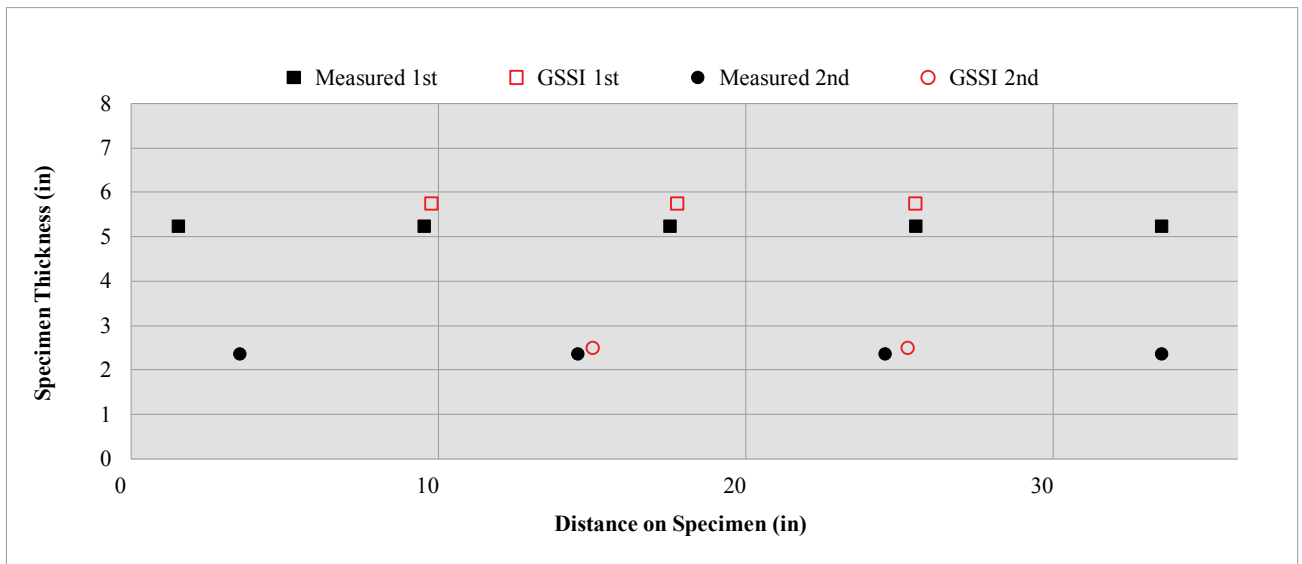

(b) Longitudinal Rebars

*Red measurements are referred to rebar positions for which it was not reported concrete coverage.

Figure 5.4. GSSI On-Site Results for 8 inches Thickness Reinforced Specimen Elevated.

9.5-inches Thickness Reinforced Specimen (Small Rebars)

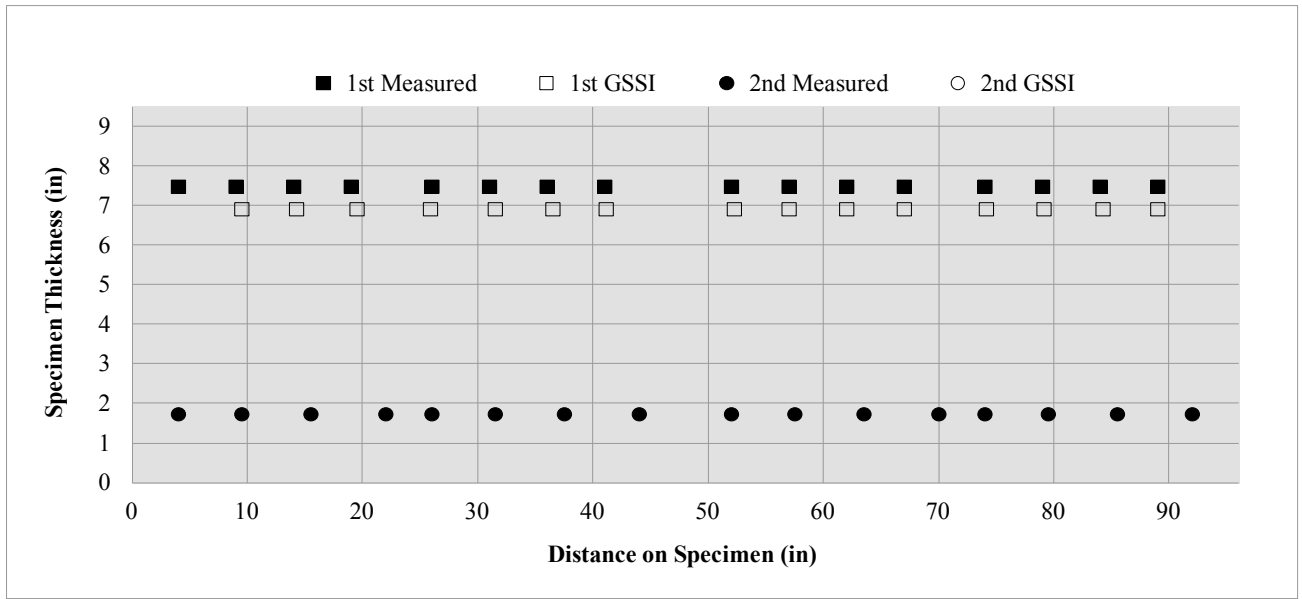

(a) Transverse Rebars

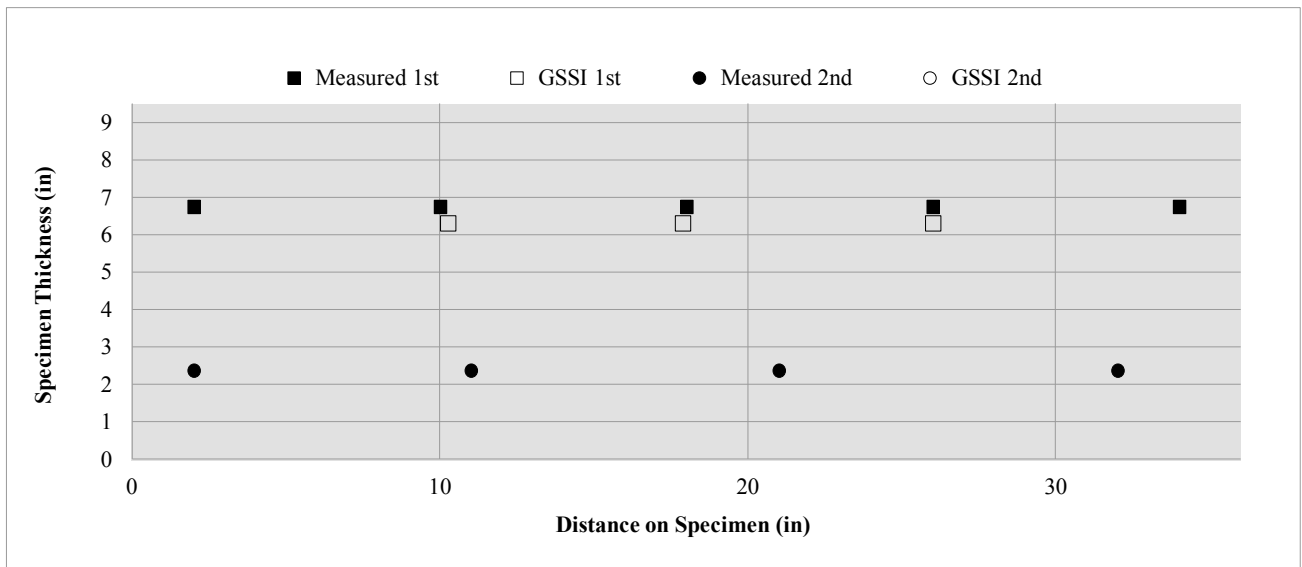

(b) Longitudinal Rebars

Figure 5.5. GSSI On-Site Results for 9.5 inches Thickness Reinforced Specimen (Small Rebars).

9.5-inches Thickness Reinforced Specimen (Big Rebars)

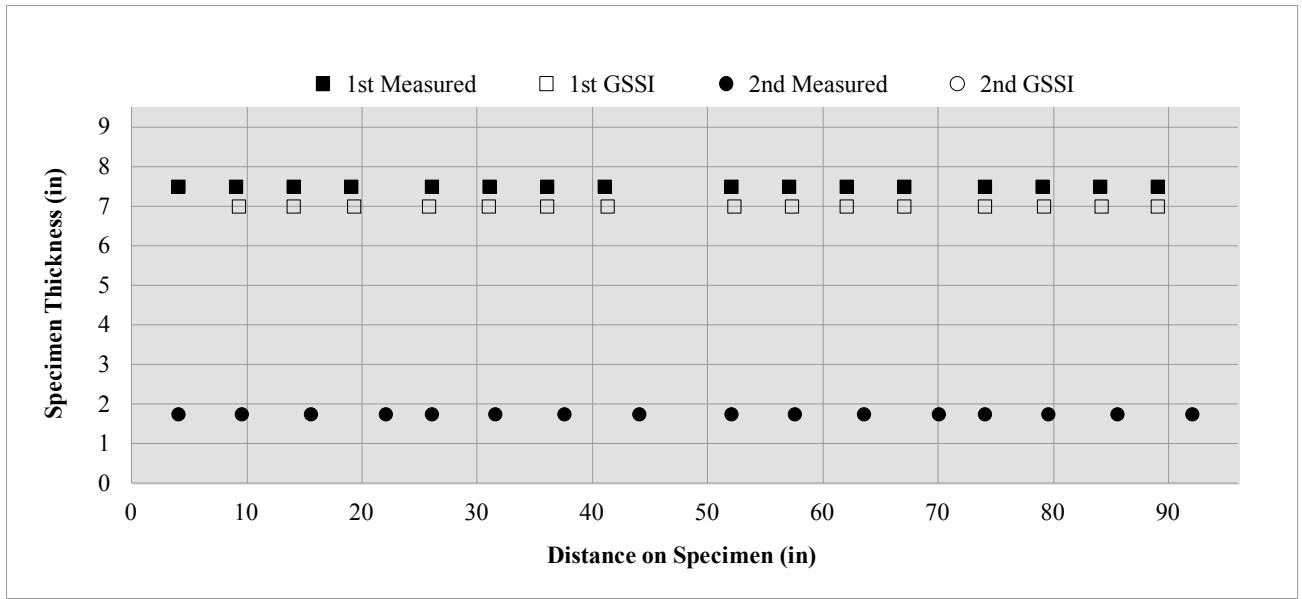

(a) Transverse Rebars

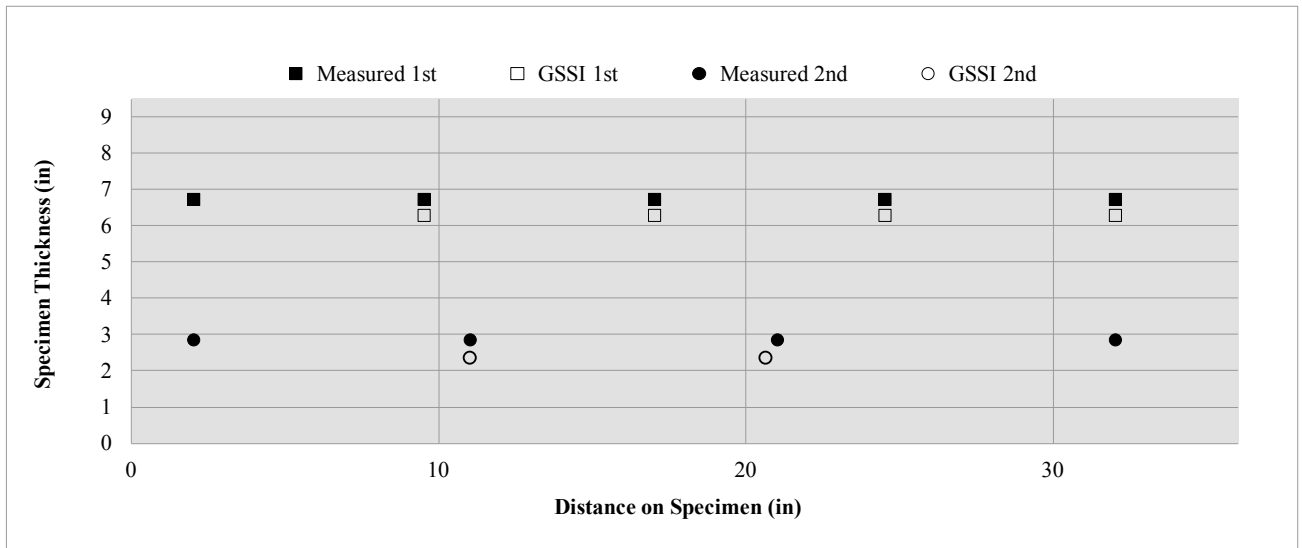

(b) Longitudinal Rebars

Figure 5.6. GSSI On-Site Results for 9.5 inches Thickness Reinforced Specimen (Big Rebars).

10-inches Thickness Reinforced Specimen

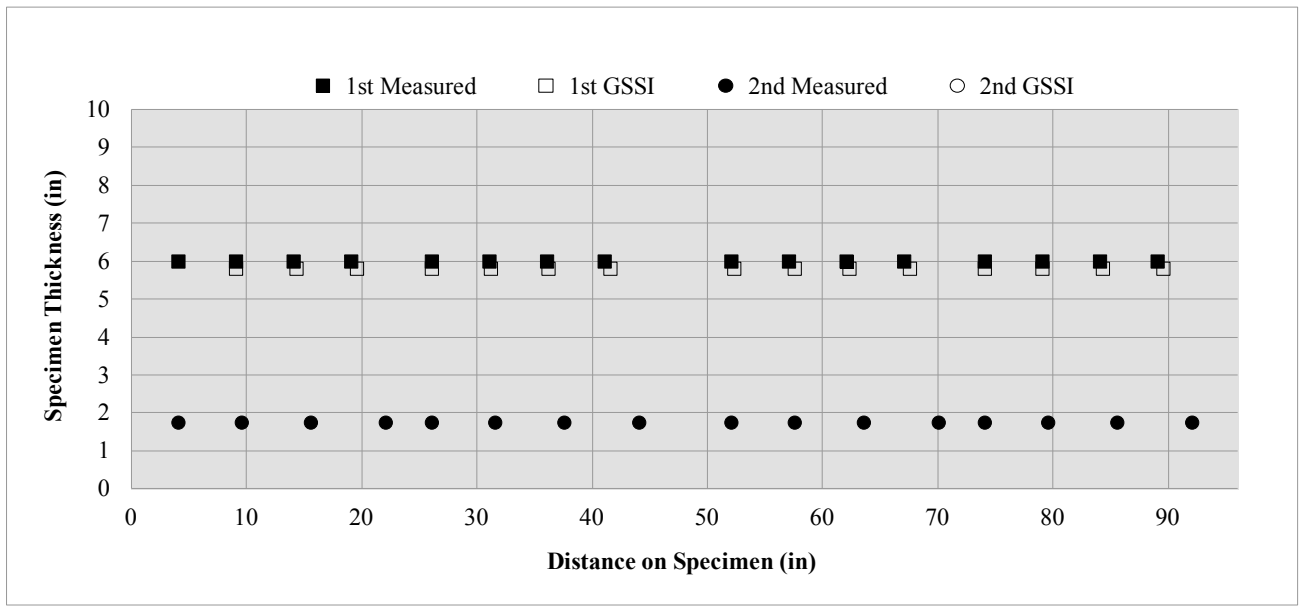

(a) Transverse Rebars

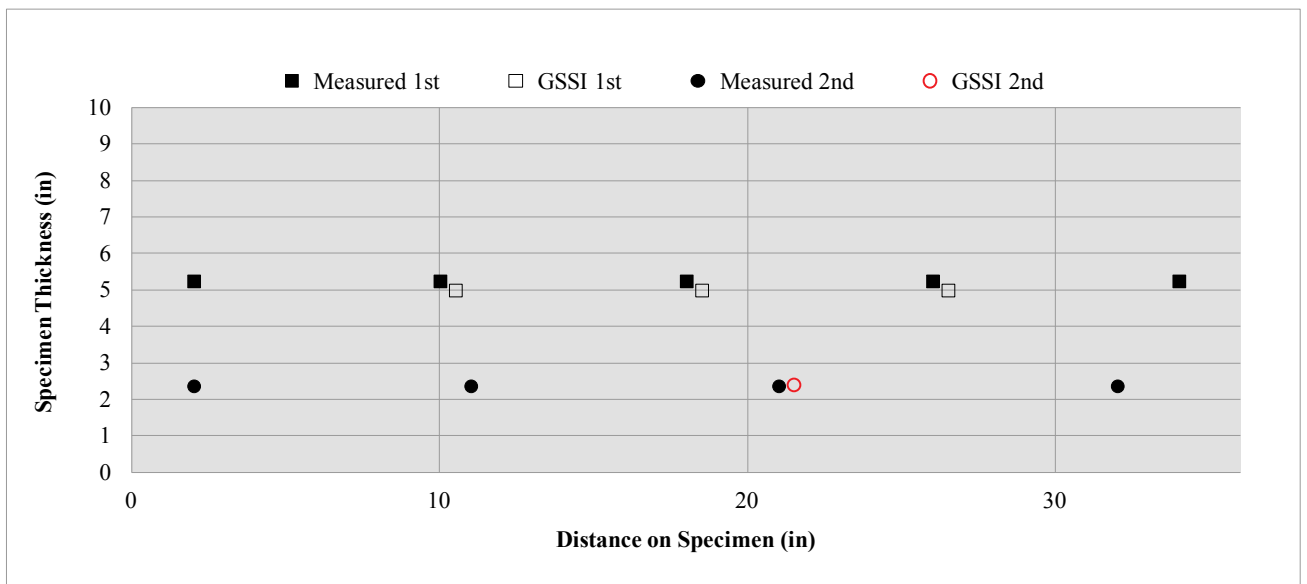

(b) Longitudinal Rebars

*Red measurements are referred to rebar positions for which it was not reported concrete coverage.

Figure 5.7. GSSI On-Site Results for 10 inches Thickness Reinforced Specimen.

10-inches Thickness Reinforced Specimen Elevated

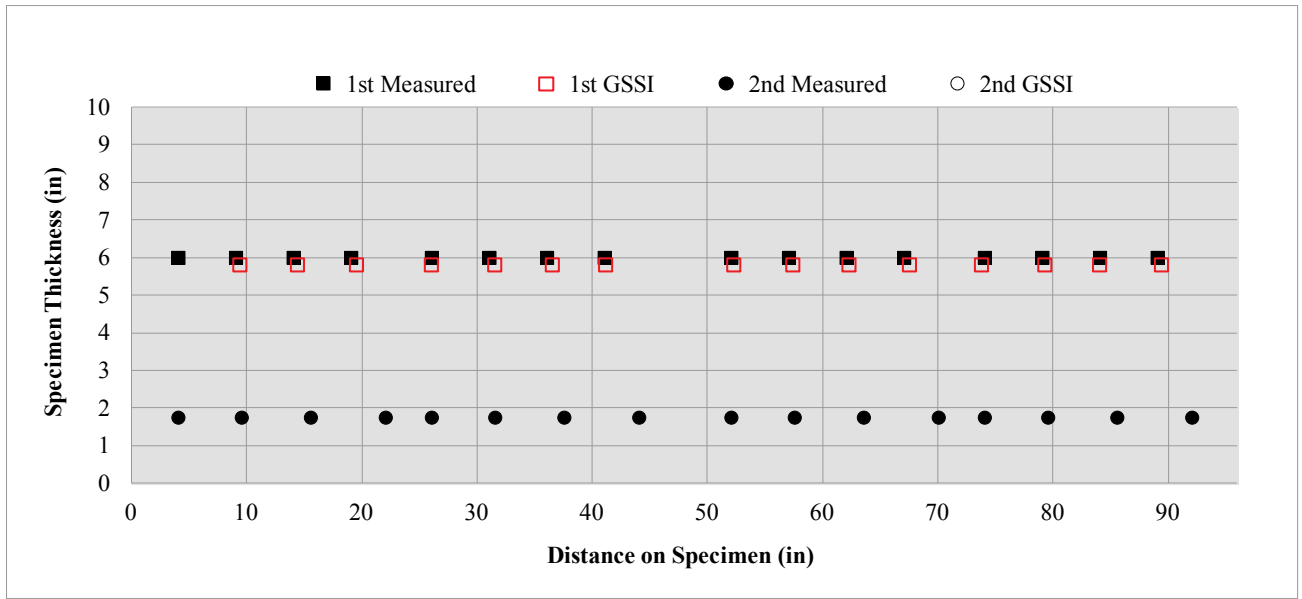

(a) Transverse Rebars

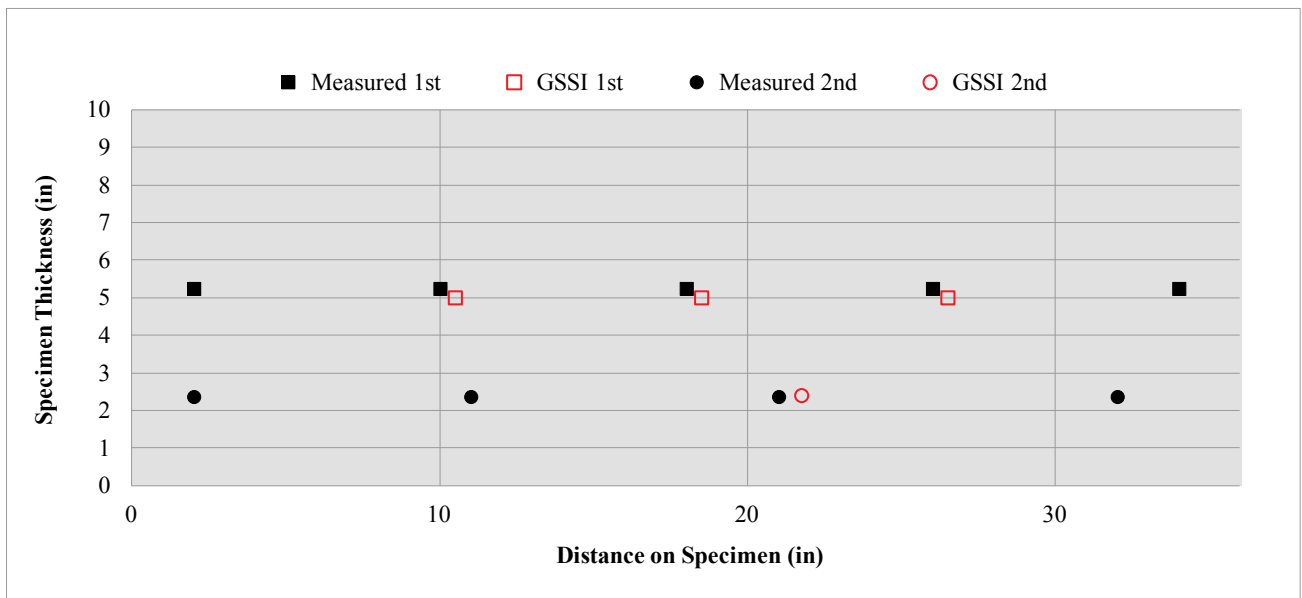

(b) Longitudinal Rebars

*Red measurements are referred to rebar positions for which it was not reported concrete coverage.

Figure 5.8. GSSI On-Site Results for 10 inches Thickness Reinforced Specimen Elevated.

Post-Processed GSSI Rebars Detection

In some cases it was difficult to determine the locations of the lower reinforcing in real-time due to the constructive and destructive interference of the reflections from the upper mesh. Consequently, the data were post-processed in GSSI's GPR data viewing and processing program RADAN7. The primary use of the program in this case was to focus the radar energy in the data using a process named "migration". Superimposed on the data are red dots indicating the detected reinforcing steel. The red dots were added by a user clicking a mouse on top of the processed data at the visually-detected rebar locations in RADAN7. The depths of the dots are indicated in the lower window in the figure. The position of the rebars was then recorded and exported to an ASCII file. The locations of all the detected rebars relative to the block edges are contained in the accompanying Excel file. It is clear the substantial imaging enhancement performed by the focusing operation permitted detection of nearly all the lower reinforcing.

Following, focused data from each block are reported in Figures 5.9 to 5.22. Also, the rebar positions determined after post processing the data collected with the GPR device from GSSI are illustrated for an effective comparison of the exact and estimated steel locations.

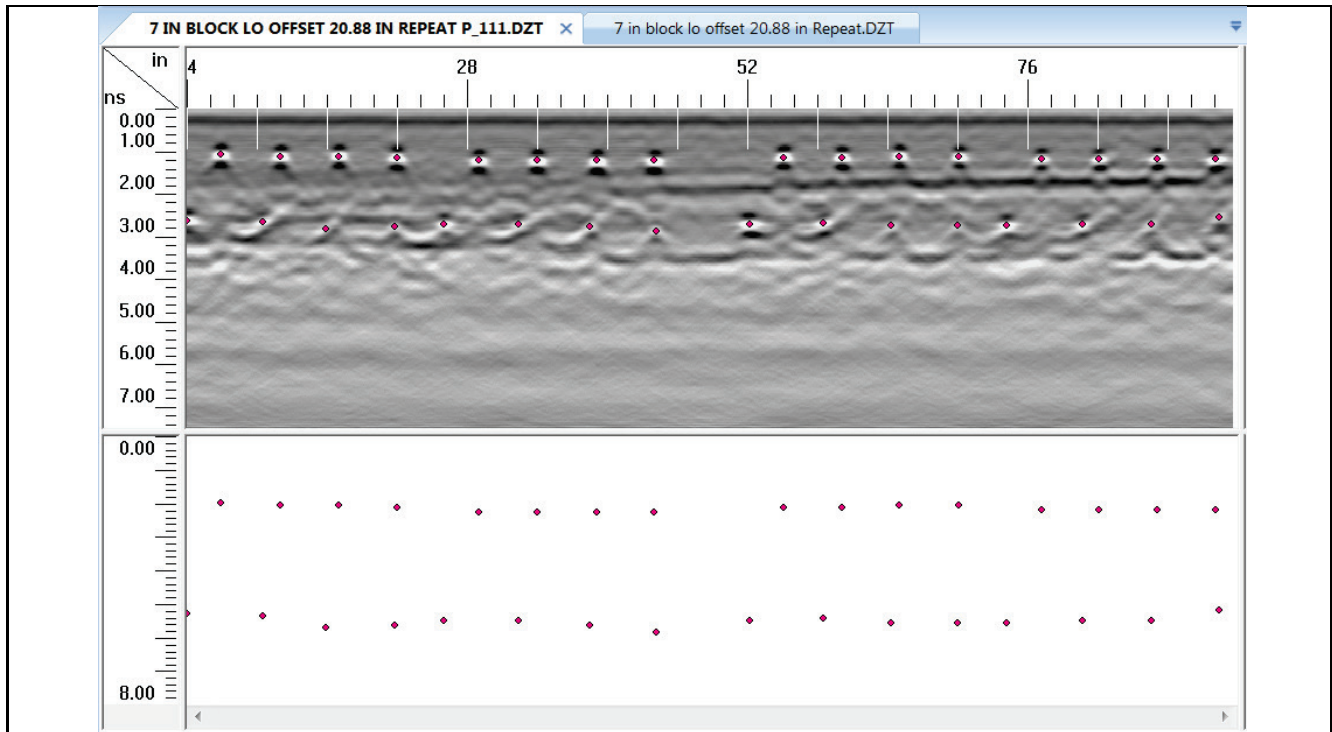

(a) Post-Processed Transverse Rebar Locations

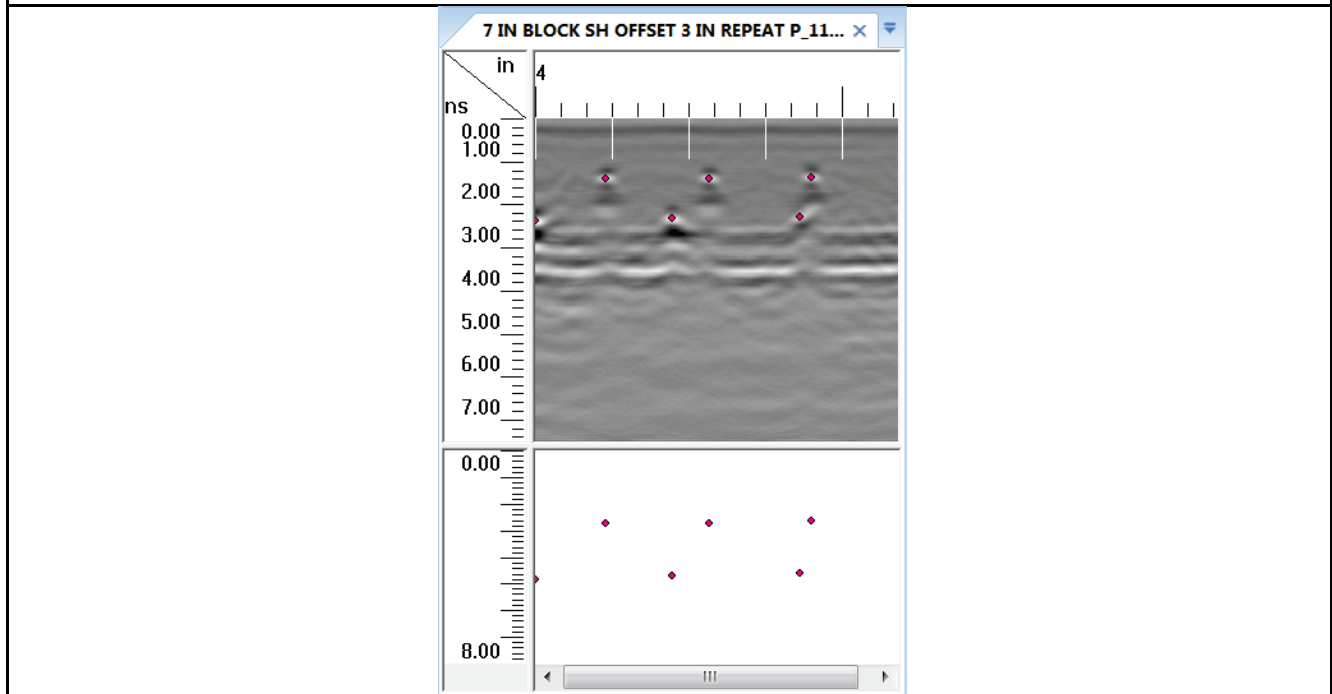

(b) Post-Processed Longitudinal Rebar Locations

Figure 5.9. GSSI Focused Data After Post-Processing of 7-inch Thick Block Results.

7-inches Thickness Reinforced Specimen

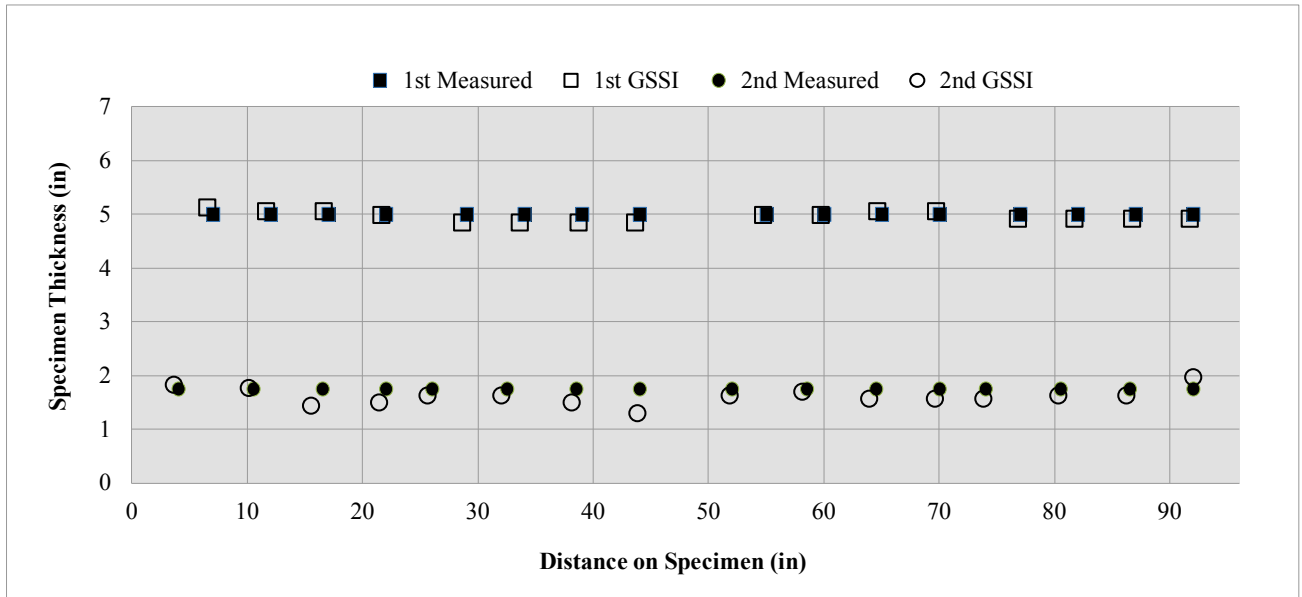

(a) Transverse Rebars

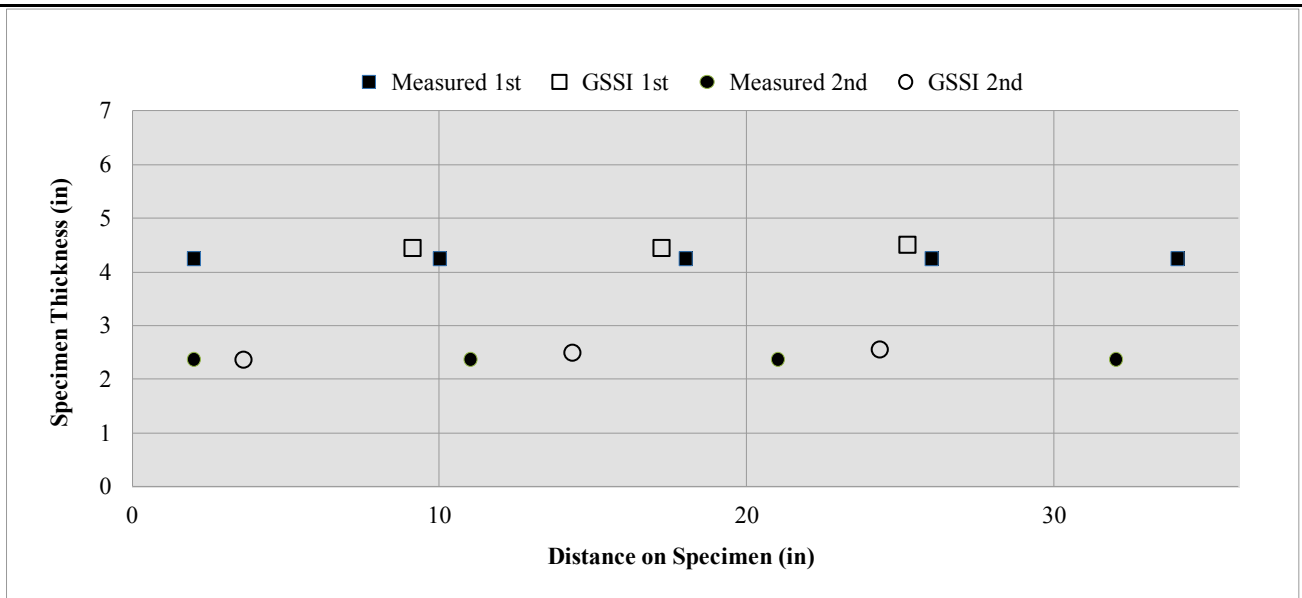

(b) Longitudinal Rebars

Figure 5.10. GSSI Post-processed Results for 7-inch Thickness Reinforced Specimen.

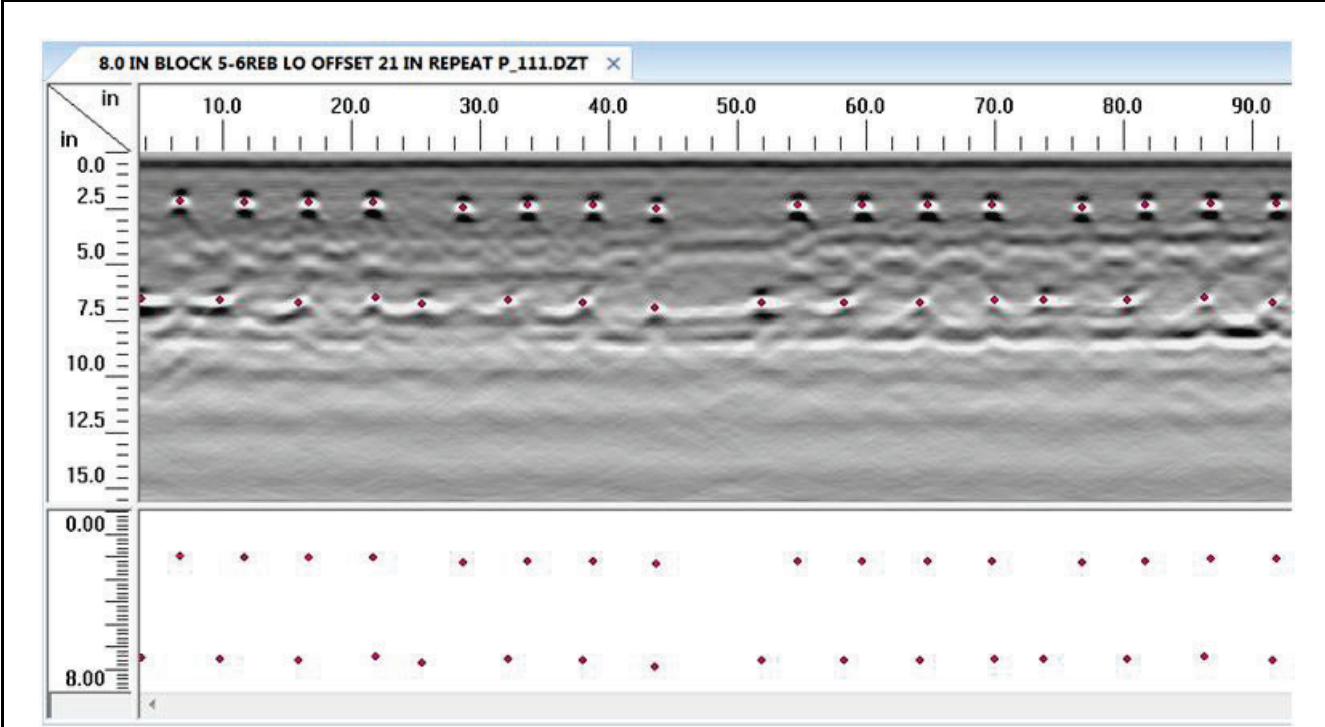

(a) Post-Processed Transverse Rebar Locations

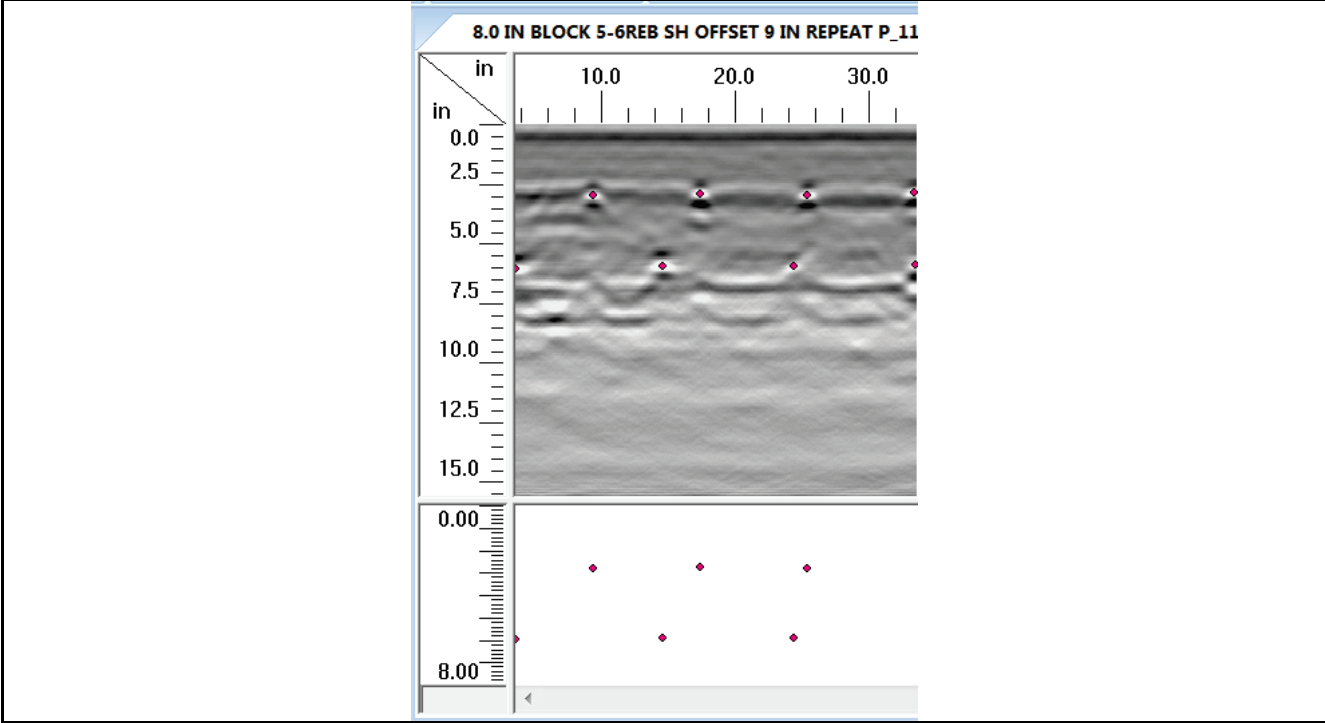

(b) Post-Processed Longitudinal Rebar Locations

Figure 5.11. GSSI Focused Data After Post-Processing of 8-inch Thick Block Results.

8-inches Thickness Reinforced Specimen

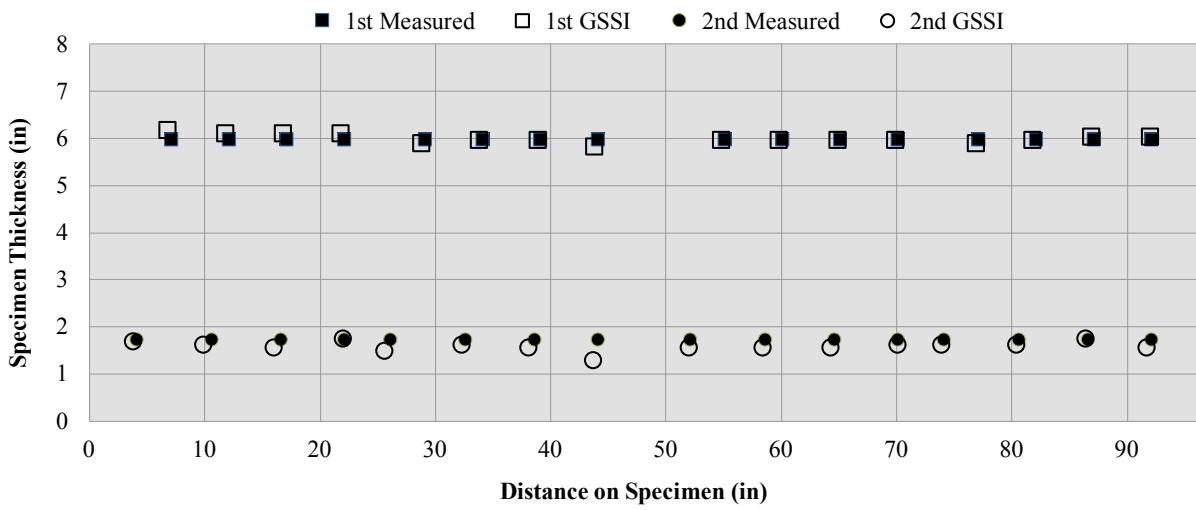

(a) Transverse Rebars

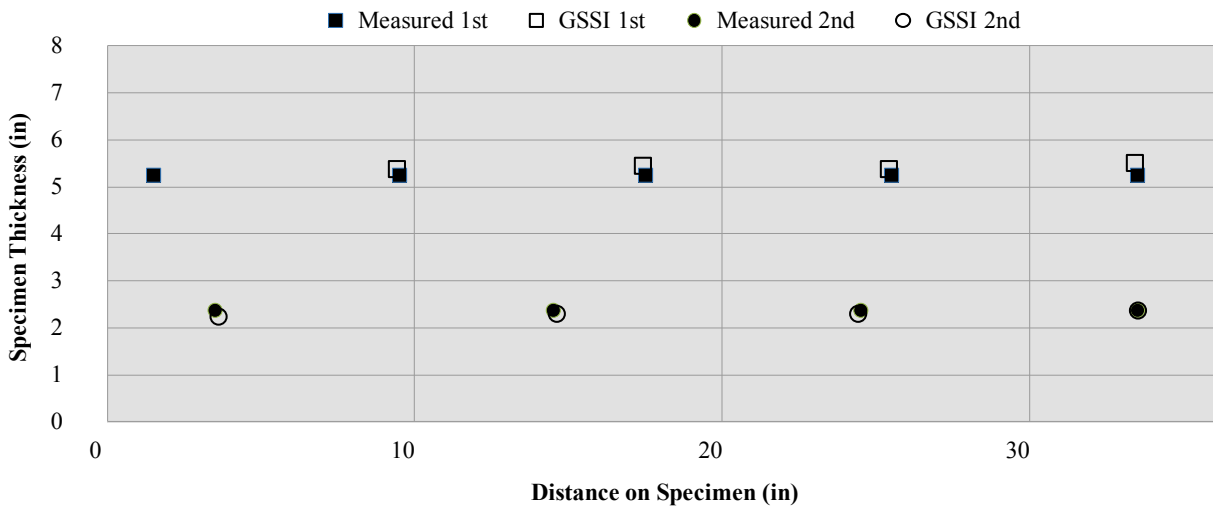

(b) Longitudinal Rebars

Figure 5.12. GSSI Post-processed Results for 8-inch Thickness Reinforced Specimen.

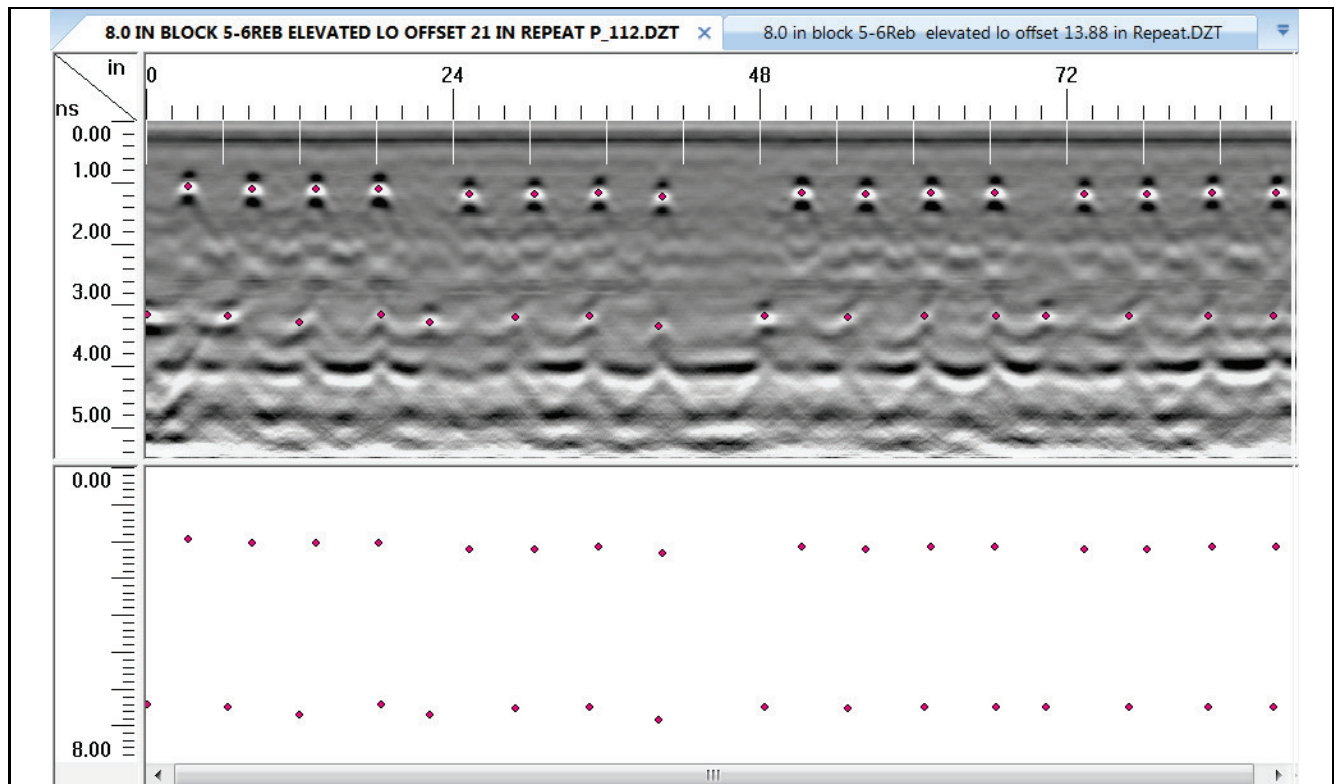

(a) Post-Processed Transverse Rebar Locations

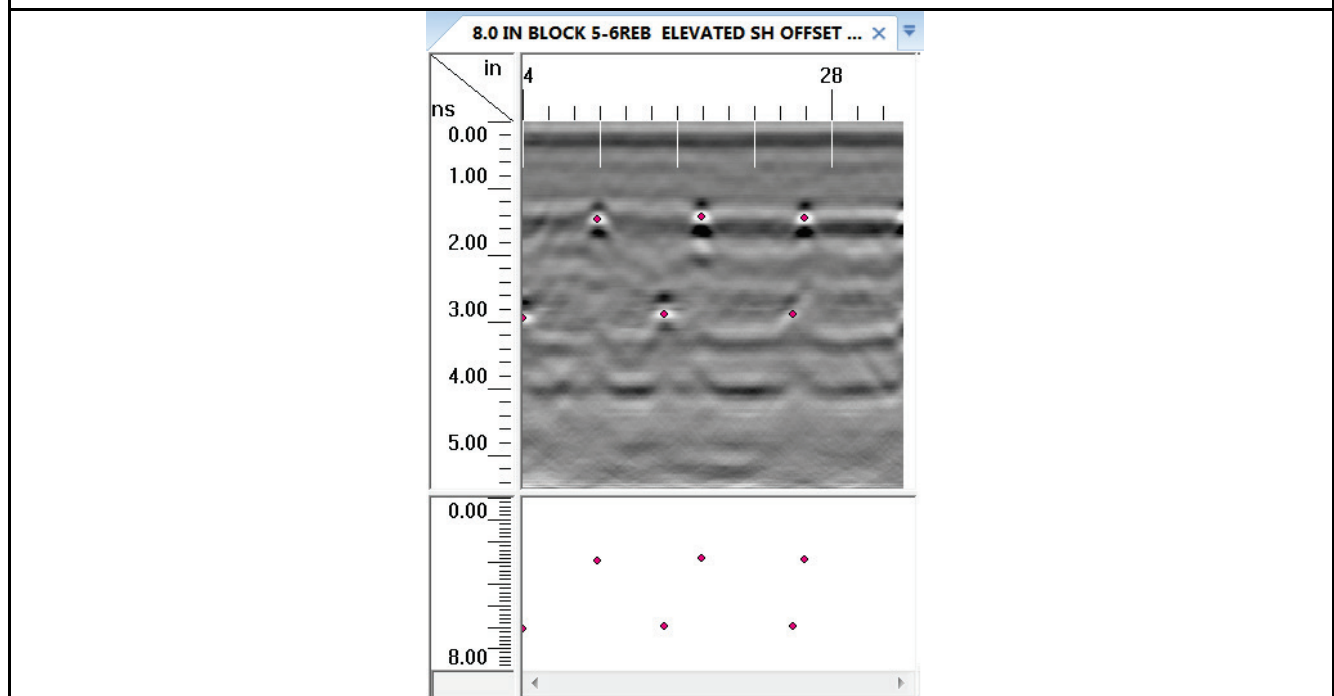

(b) Post-Processed Longitudinal Rebar Locations

Figure 5.13. GSSI Focused Data After Post-Processing of 8-inch Elevated Thick Block Results.

8-inches Thickness Reinforced Specimen Elevated

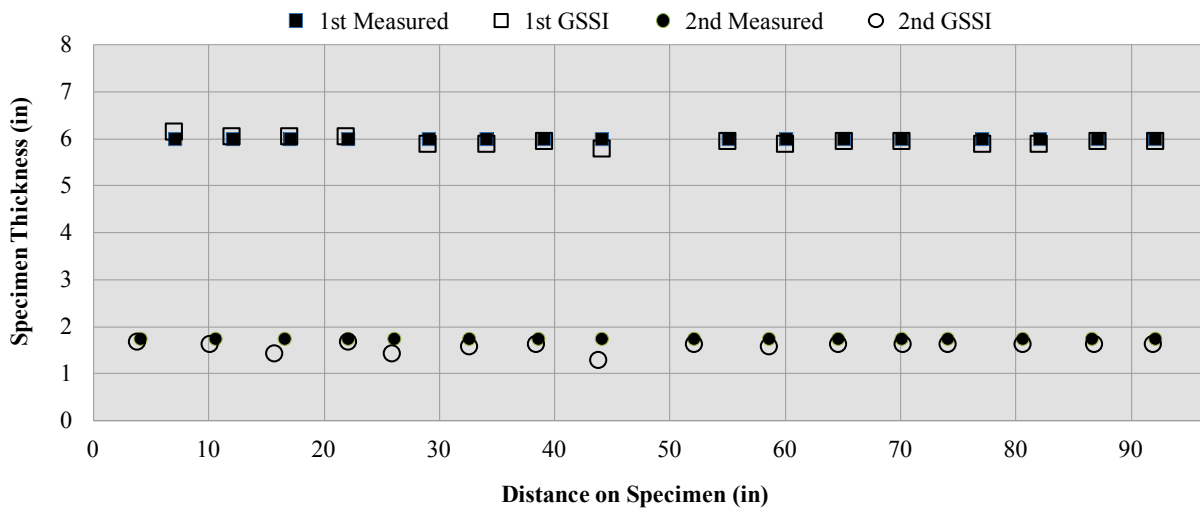

(a) Transverse Rebars

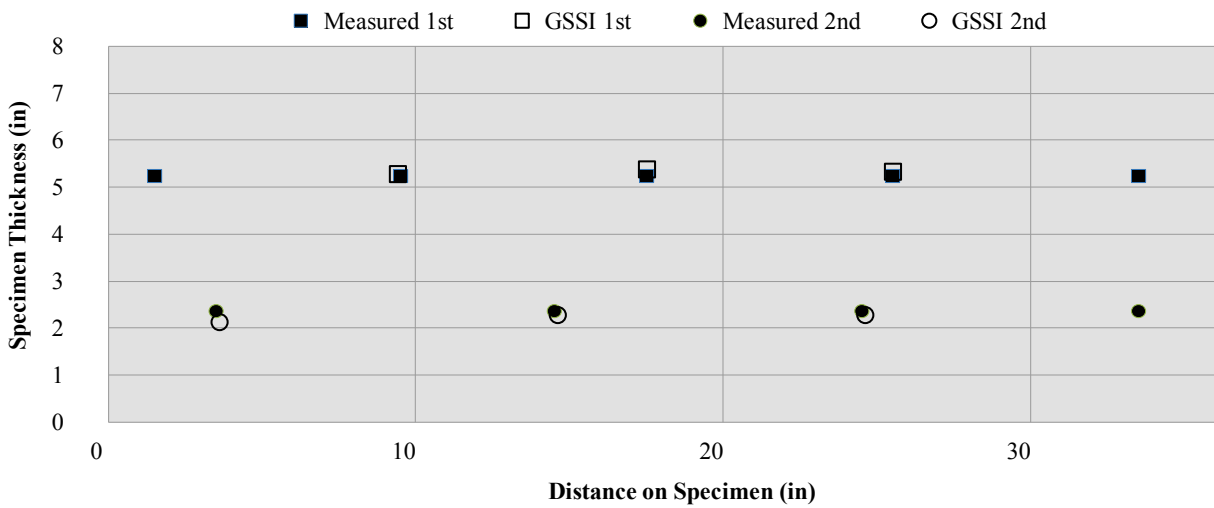

(b) Longitudinal Rebars

Figure 5.14. GSSI Post-processed Results for 8-inch Thickness Reinforced Specimen Elevated.

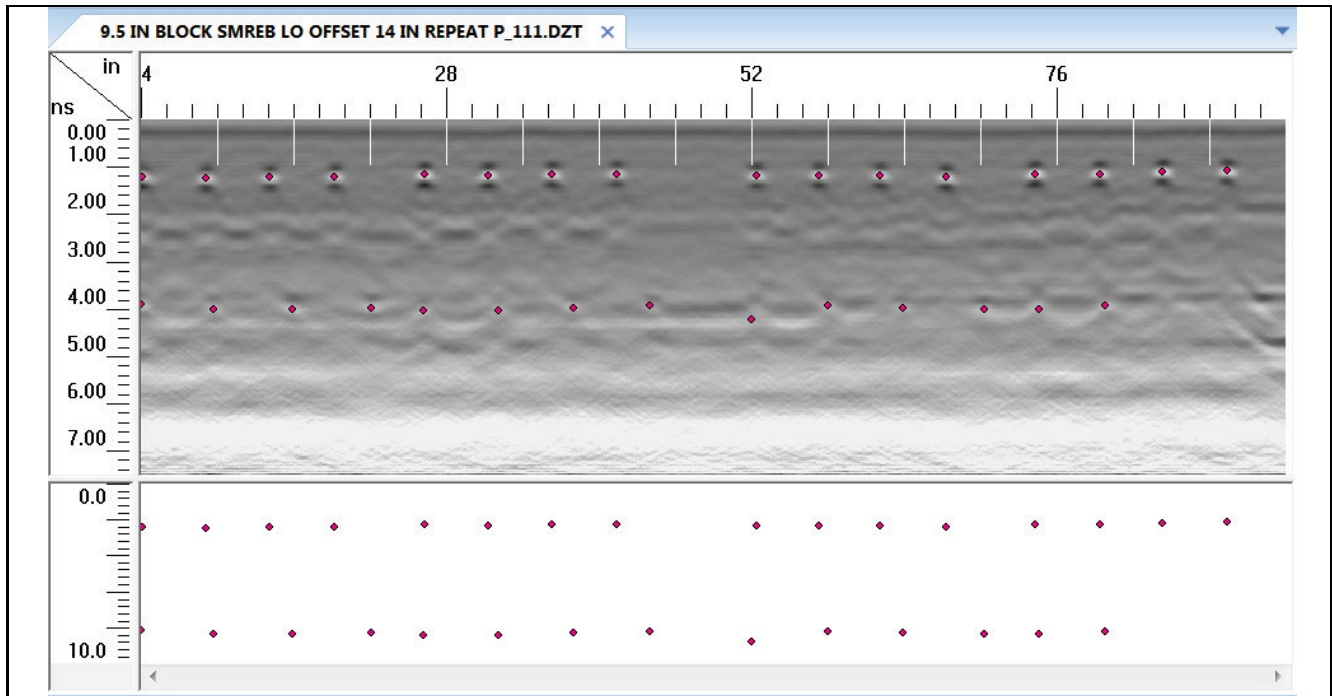

(a) Post-Processed Transverse Rebar Locations

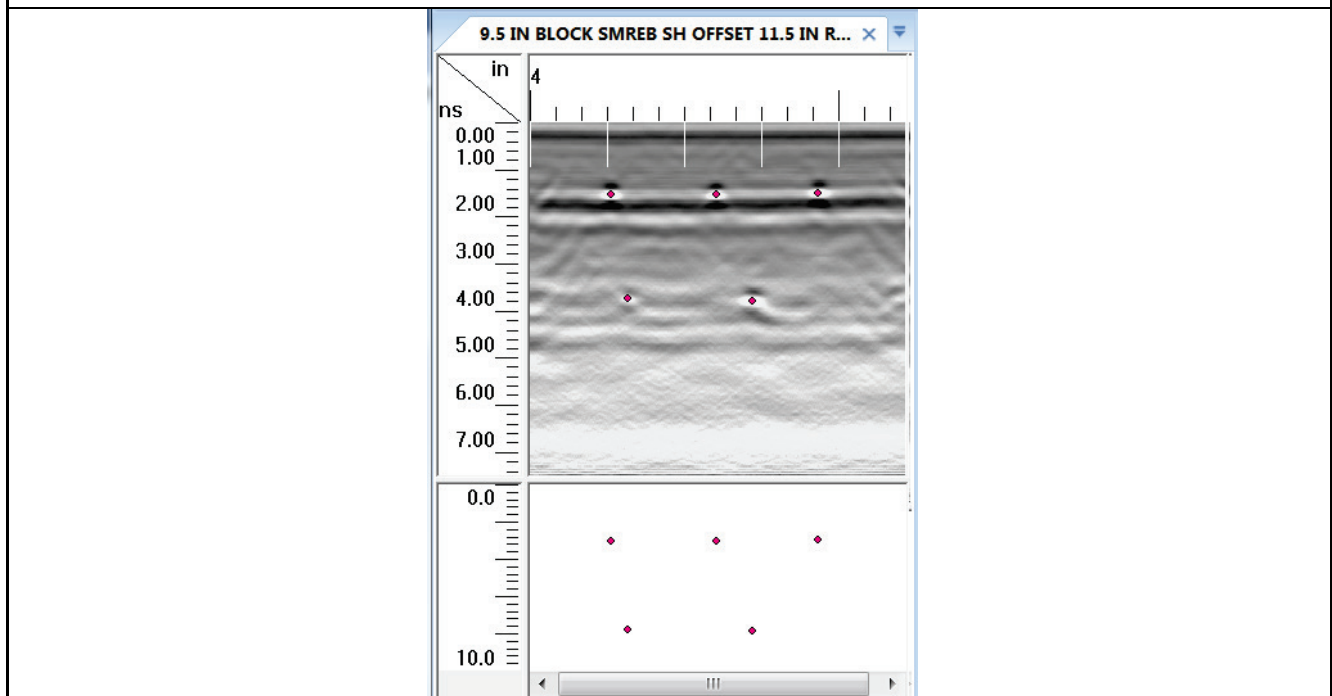

(b) Post-Processed Longitudinal Rebar Locations

Figure 5.15. GSSI Focused Data After Post-Processing of 9.5-inch Thick Block Results (Small Rebars).

9.5-inches Thickness Reinforced Specimen (Small Rebars)

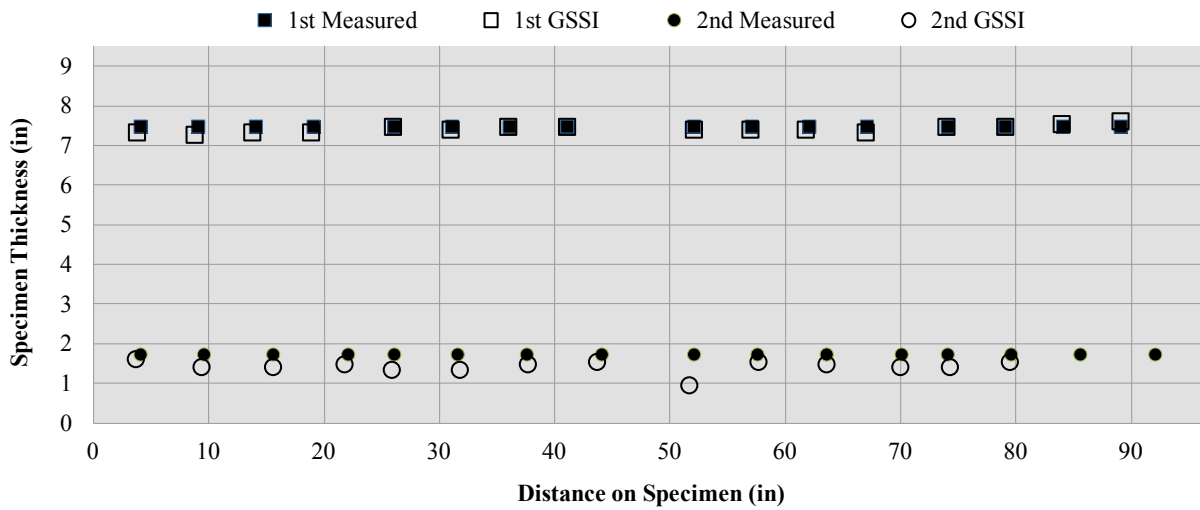

(a) Transverse Rebars

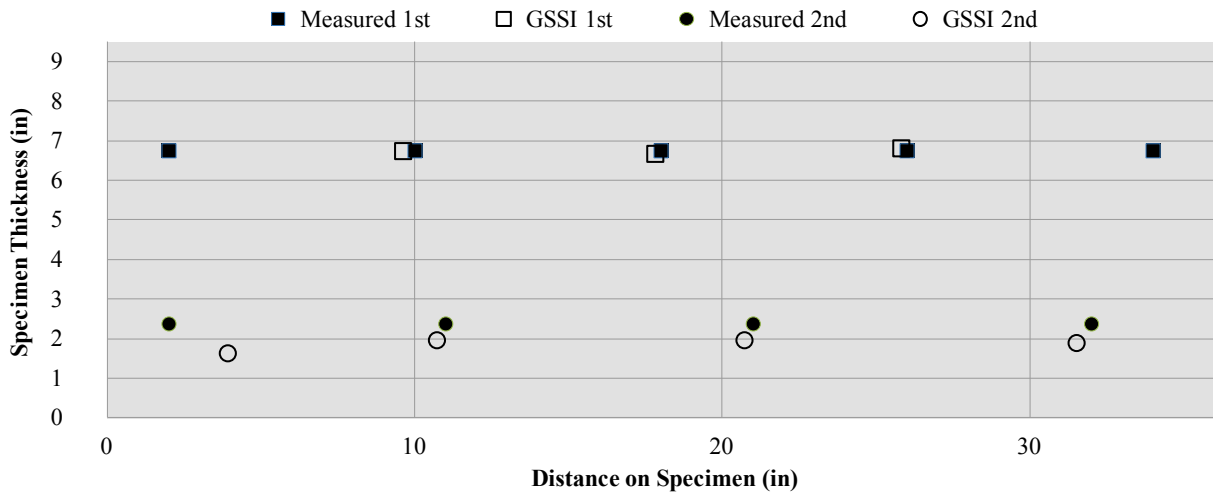

(b) Longitudinal Rebars

Figure 5.16. GSSI Post-processed Results for 9.5-inch Thickness Reinforced Specimen (Small Rebars).

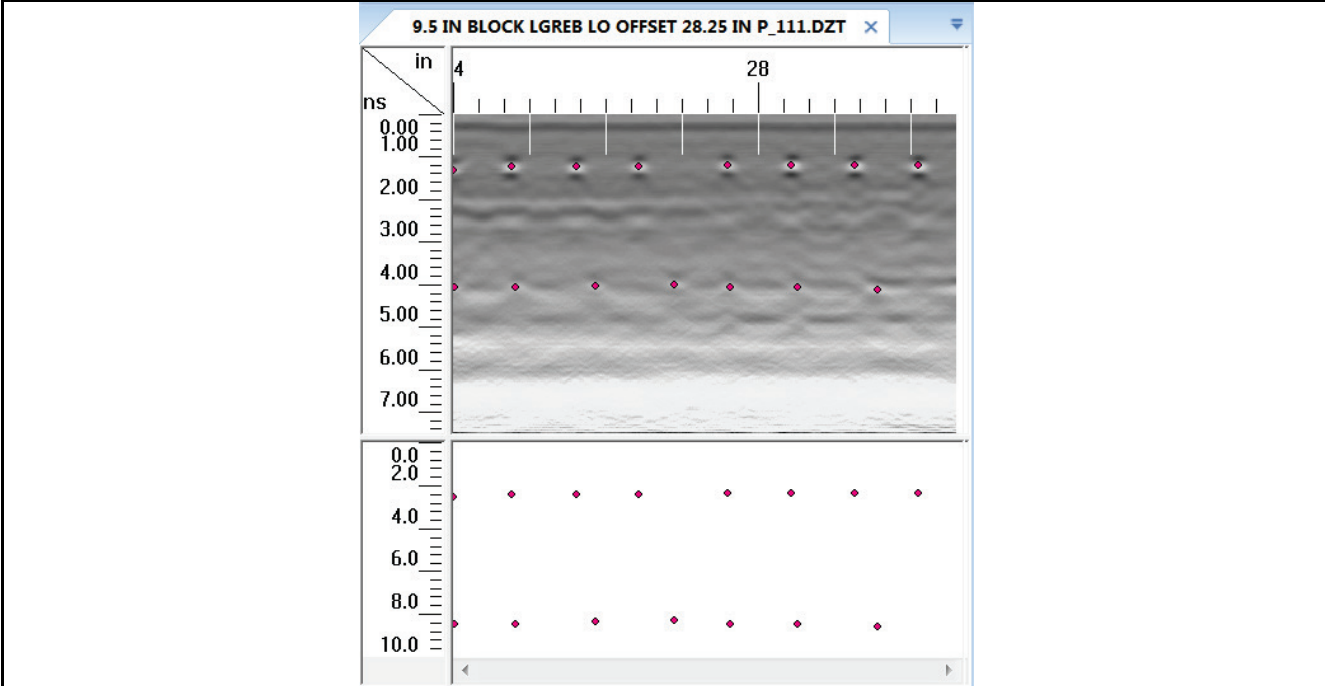

(a) Post-Processed Transverse Rebar Locations - Line was terminated before end of block due to vertical bolt block path of the unit.

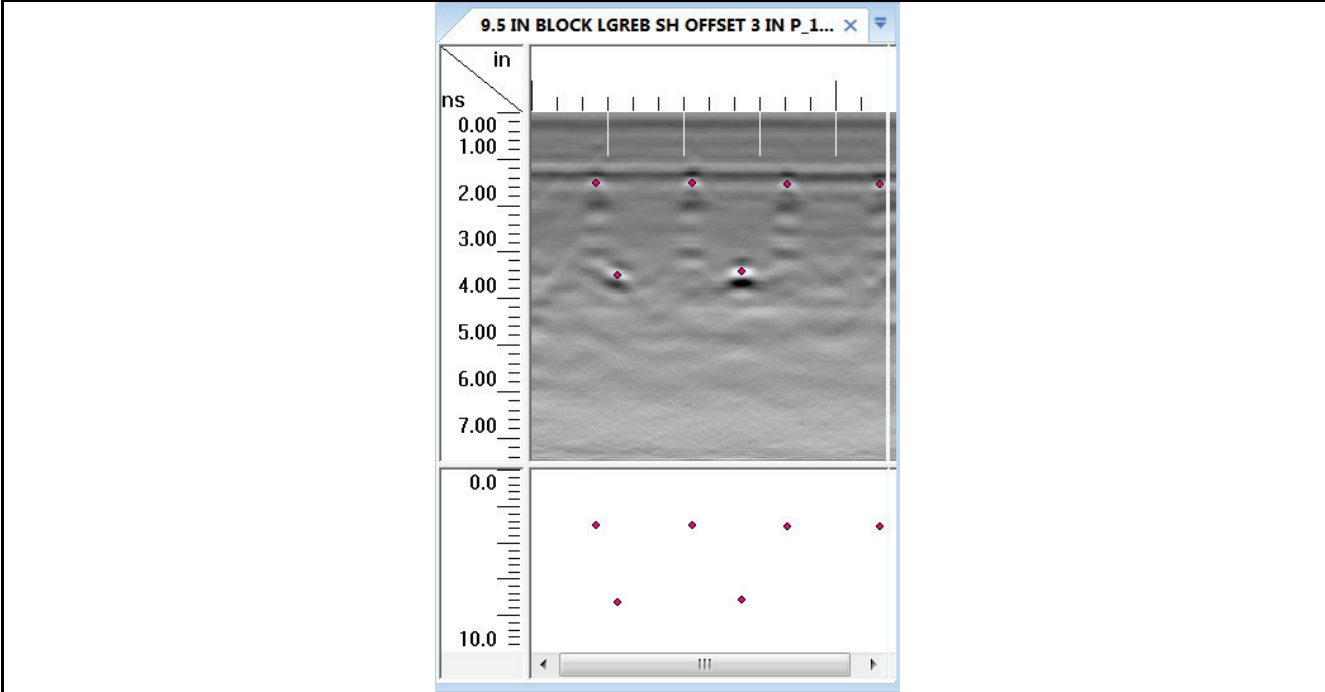

(b) Post-Processed Longitudinal Rebar Locations

Figure 5.17. GSSI Focused Data After Post-Processing of 9.5-inch Thick Block Results (Big Rebars).

9.5-inches Thickness Reinforced Specimen (Big Rebars)

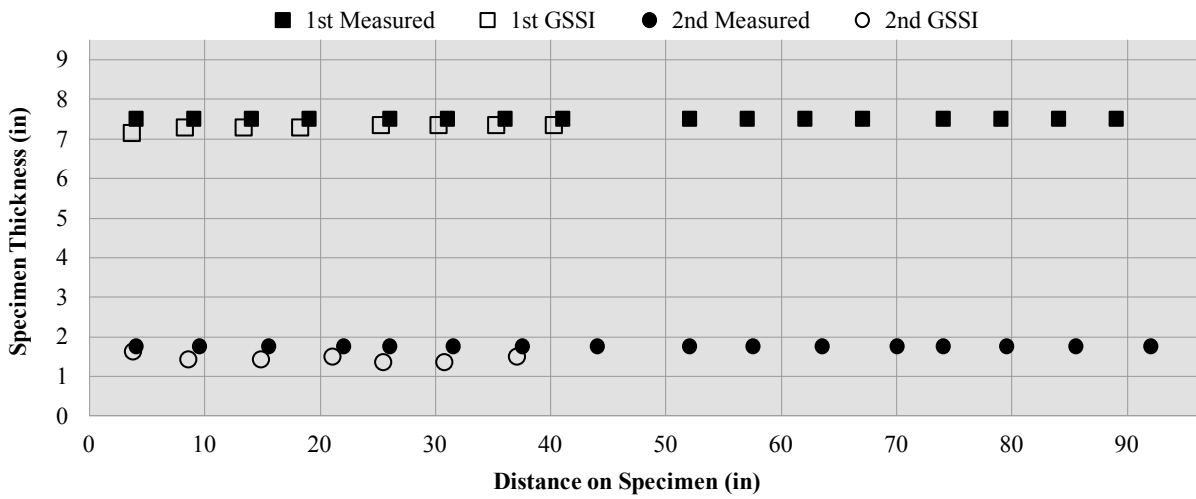

(a) Transverse Rebars

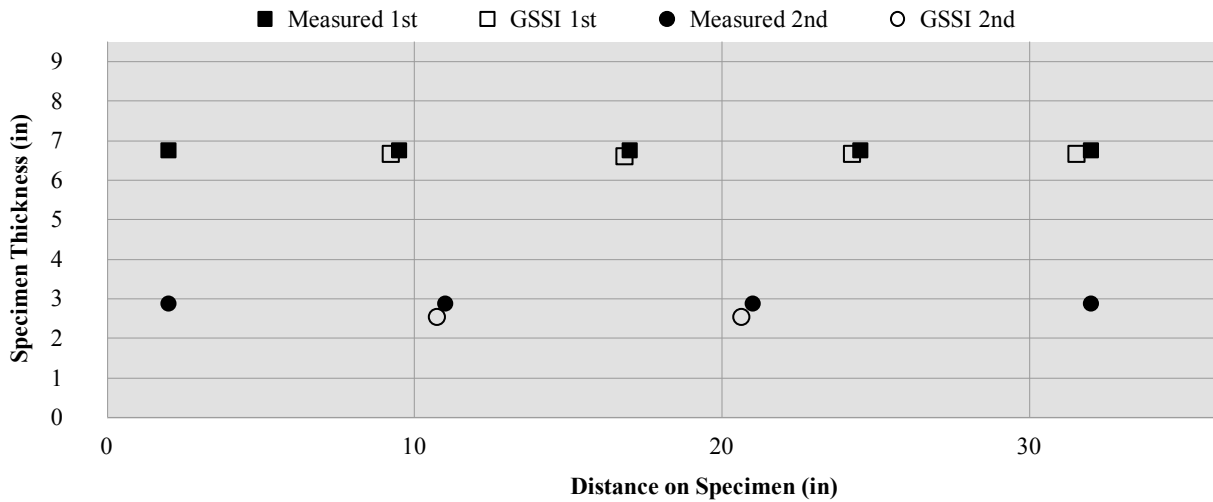

(b) Longitudinal Rebars

Figure 5.18. GSSI Post-processed Results for 9.5-inch Thickness Reinforced Specimen (Big Rebars).

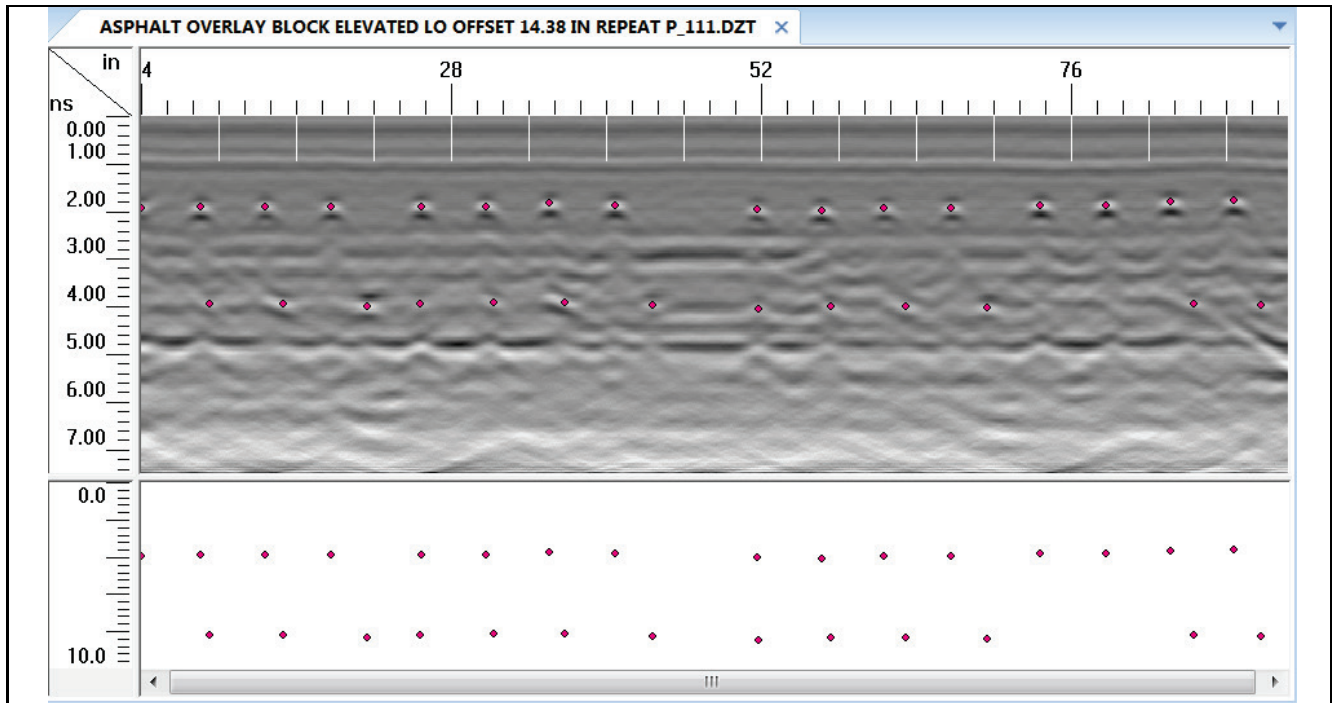

(a) Post-Processed Transverse Rebar Locations

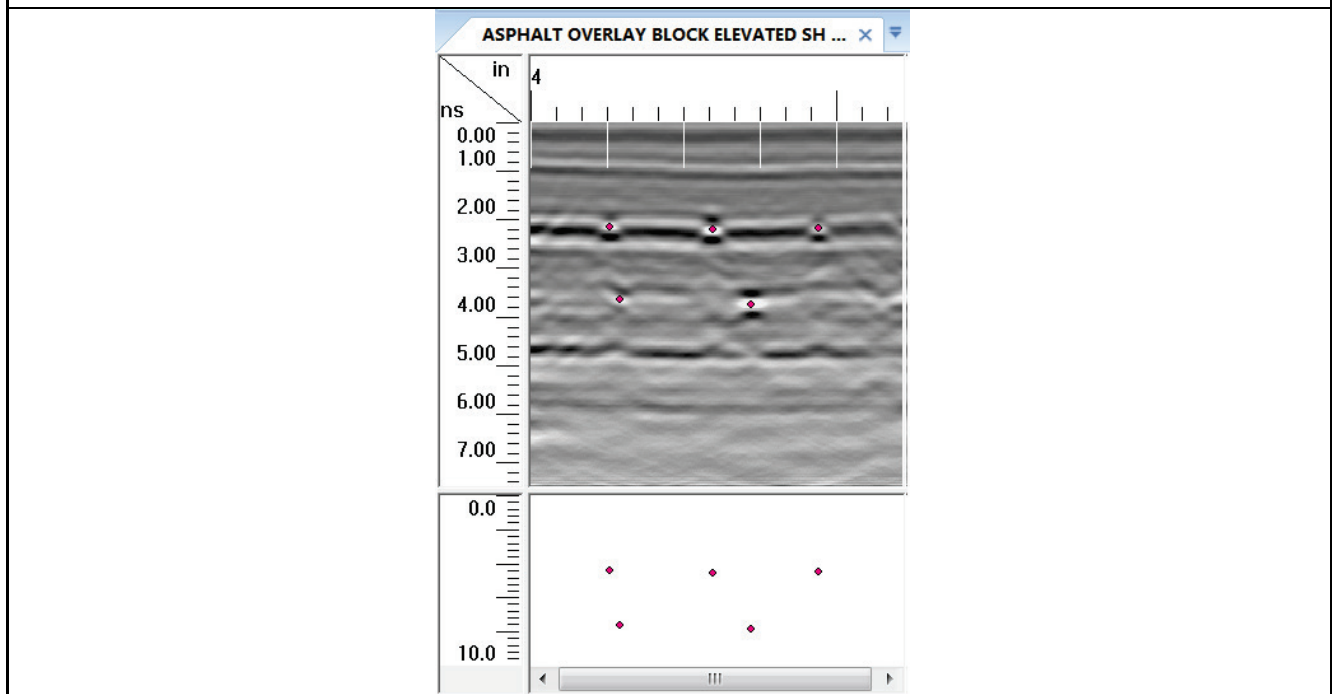

(b) Post-Processed Longitudinal Rebar Locations

Figure 5.19. GSSI Focused Data After Post-Processing of 10-inch Elevated Thick Block Results.

10-inches Thickness Reinforced Specimen Elevated

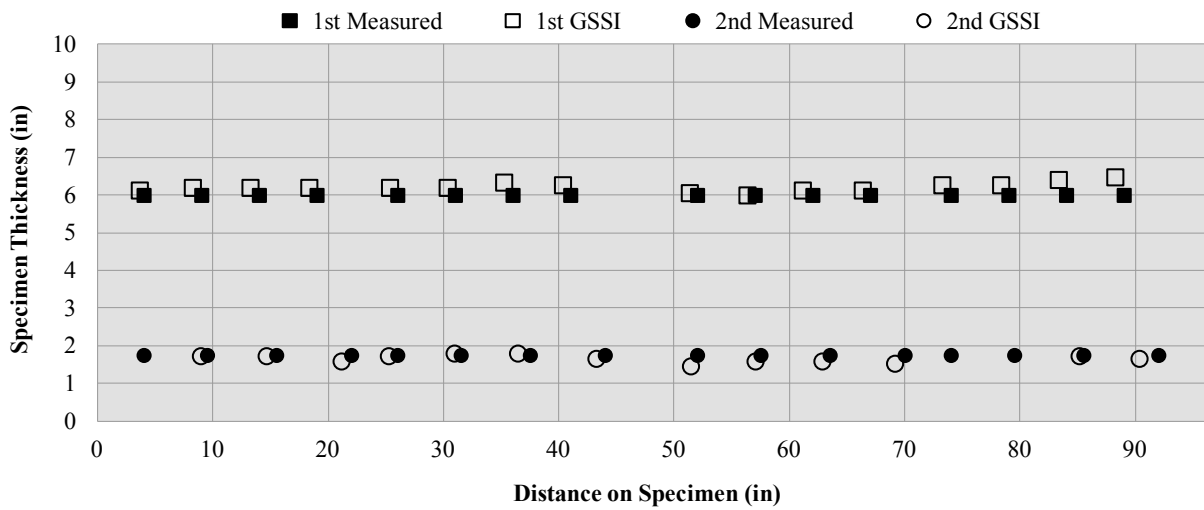

(a) Transverse Rebars

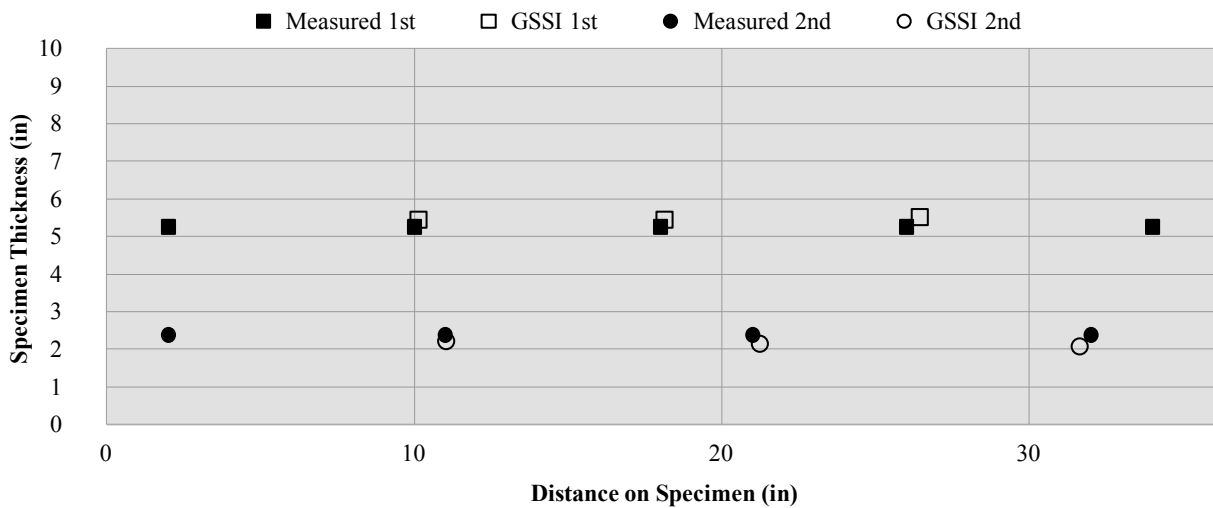

(b) Longitudinal Rebars

Figure 5.20. GSSI Post-processed Results for 10-inch Thickness Reinforced Specimen Elevated.

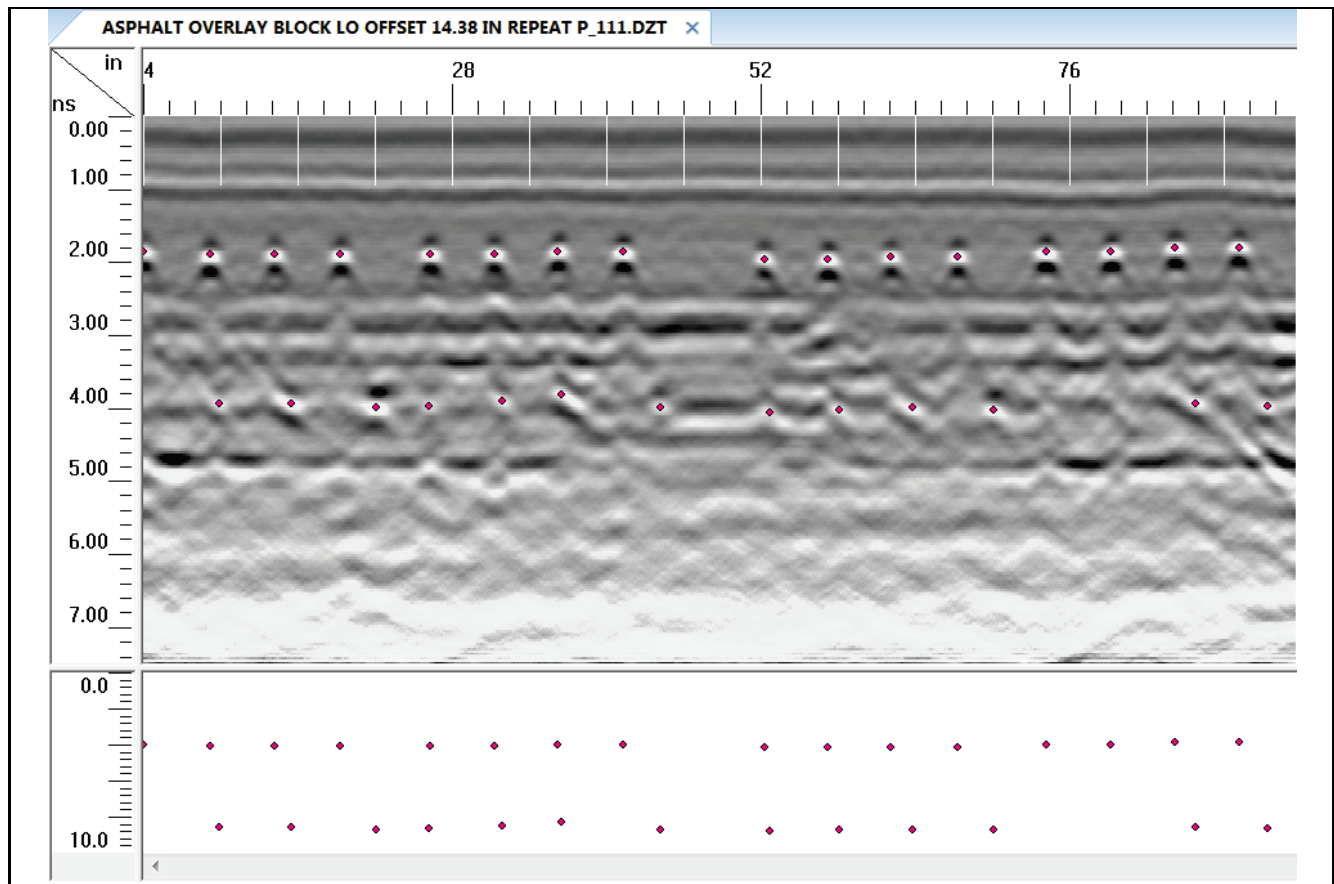

(a) Post-Processed Transverse Rebar Locations

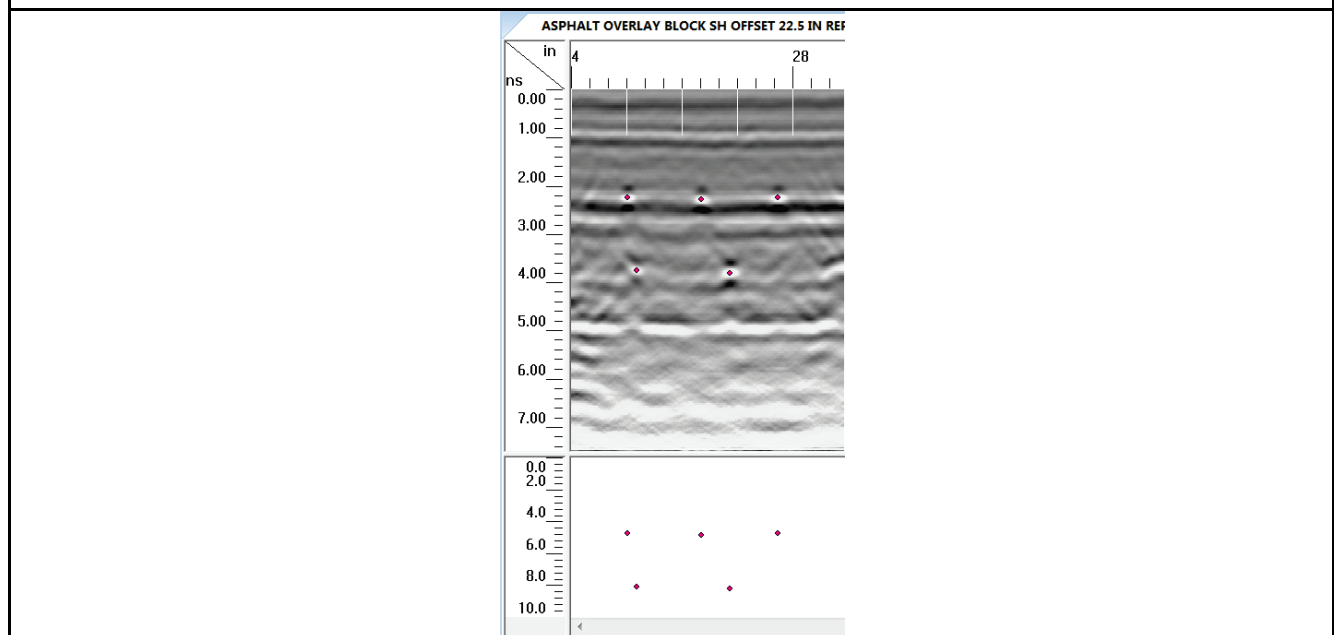

(b) Post-Processed Longitudinal Rebar Locations

Figure 5.21. GSSI Focused Data After Post-Processing of 10-inch Thick Block Results.

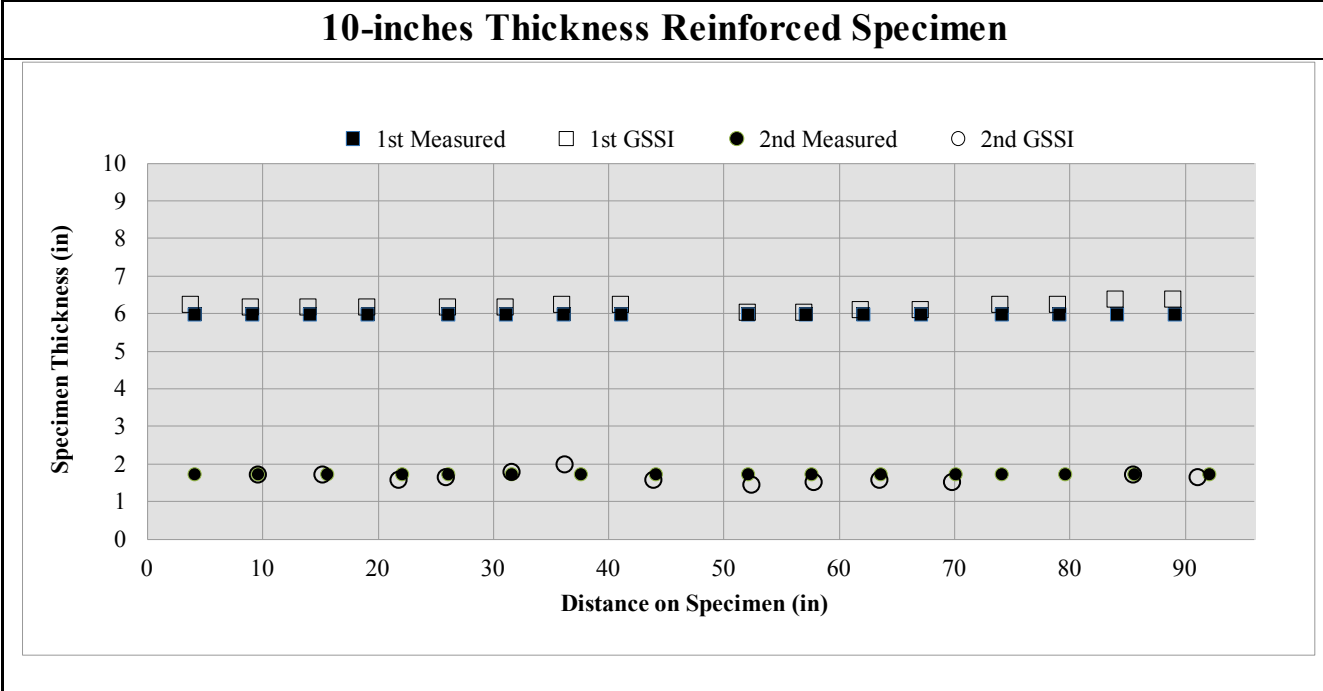

(a) Transverse Rebars

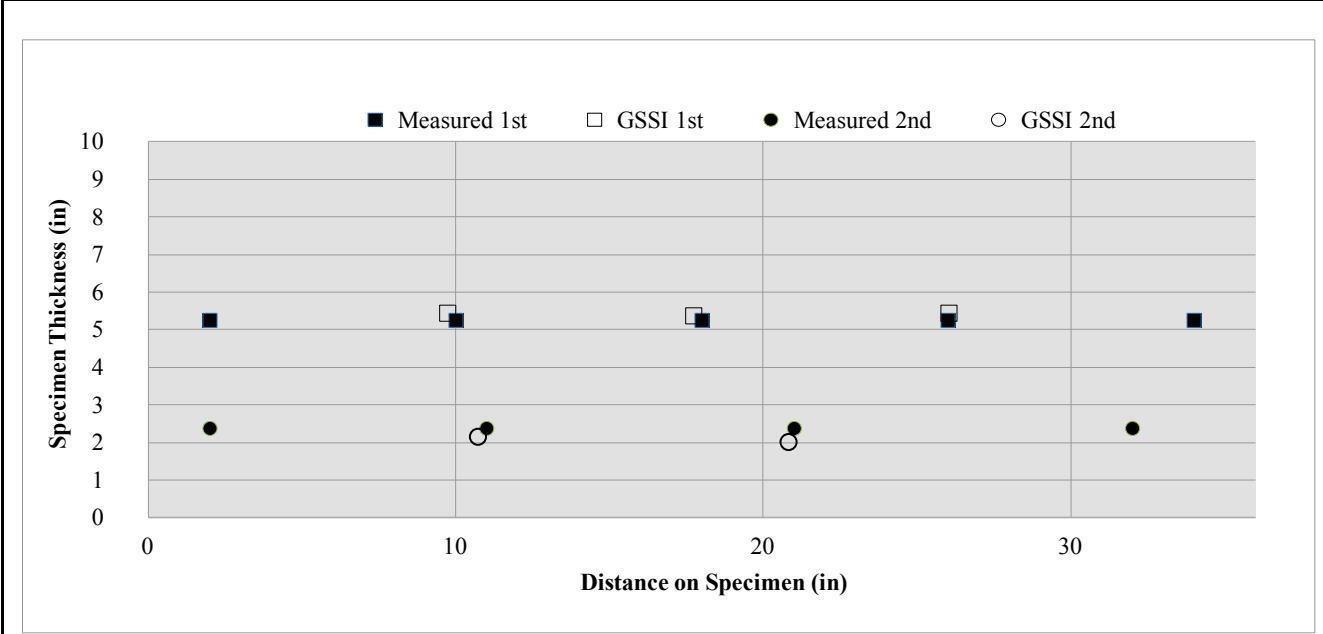

(b) Longitudinal Rebars

Figure 5.22. GSSI Post-processed Results for 10-inch Thickness Reinforced Specimen.

HILTI Results

Details on the characteristics and use of the Hilti GPR device are reported in Appendix F

On-Site Rebars Hilti Detection

Figures 5.23 to 5.43 show the results obtained from the reinforced concrete specimens scanning with the PS 1000 X-Scan from Hilti. Each figure reports the measured exact position of the steel reinforcement from the first and second layer in each slab. Also, the rebars positions determined by the GPR device from Hilti on site measurements are illustrated for an effective comparison of the exact and estimated steel locations.

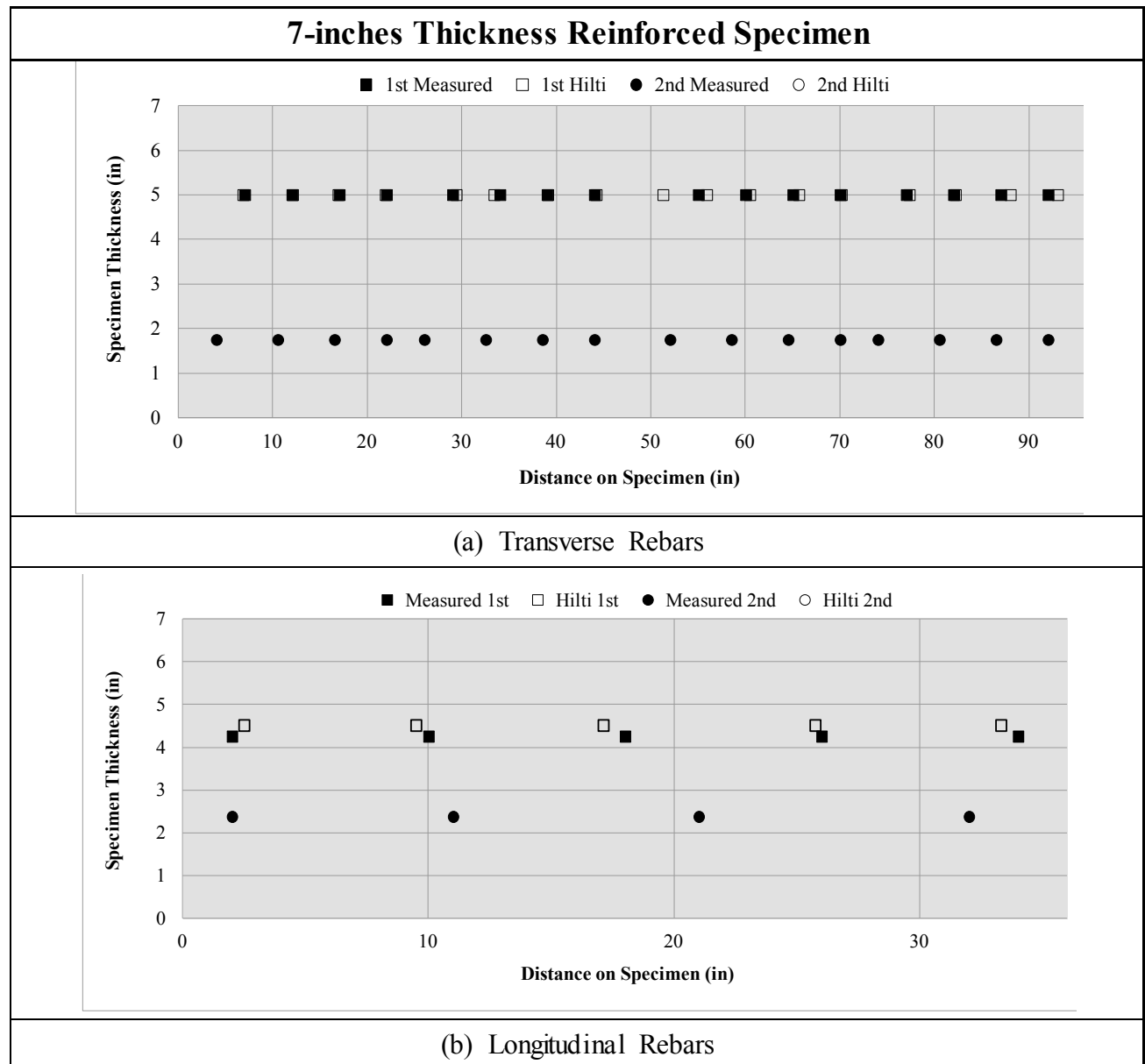
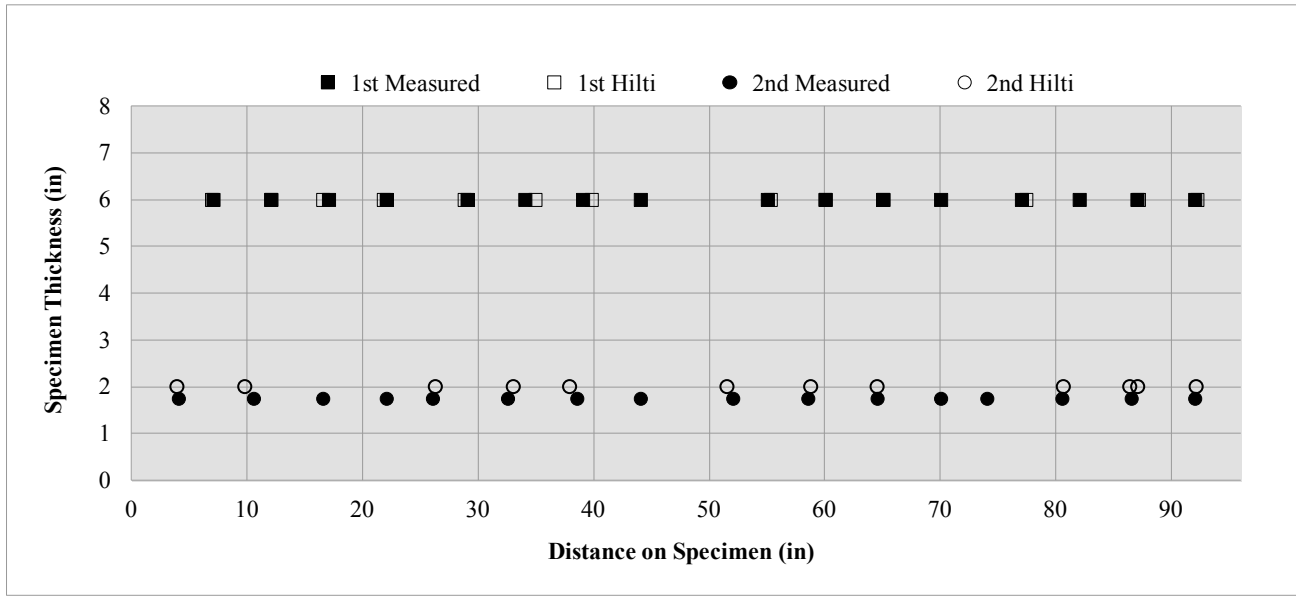
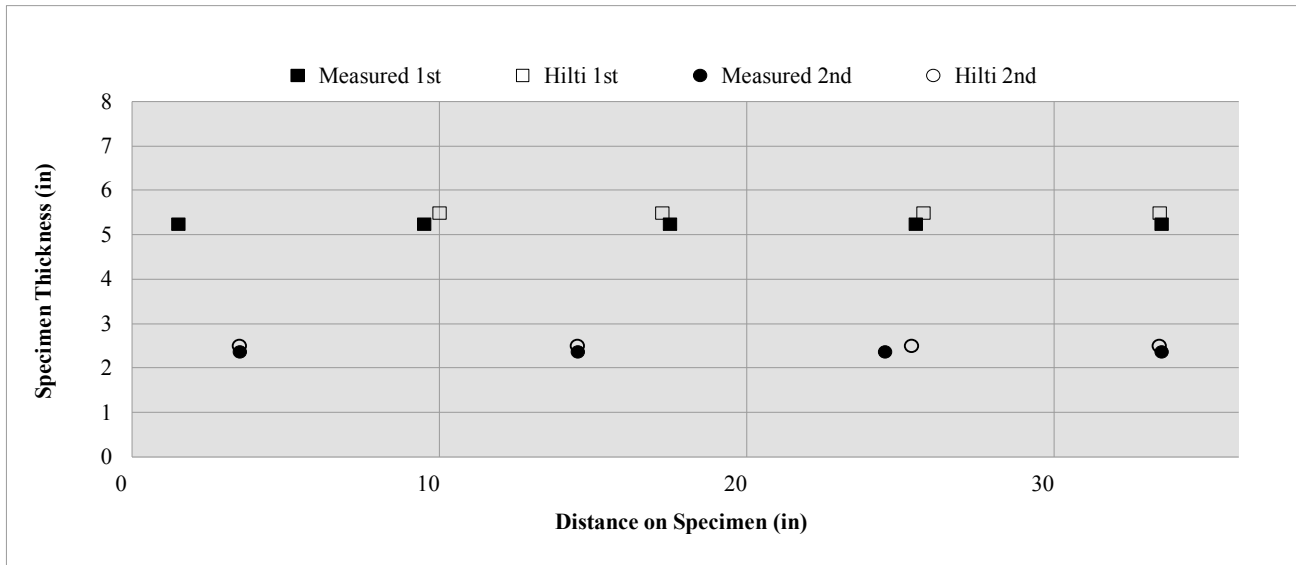

Figure 5.23. Hilti (PS1000) On-Site Results for 7-inch Thickness Reinforced Specimen.

8-inches Thickness Reinforced Specimen



(a) Transverse Rebars



(b) Longitudinal Rebars

Figure 5.24. Hilti (PS1000) On-Site Results for 8-inch Thickness Reinforced Specimen.

8-inches Thickness Reinforced Specimen Elevated

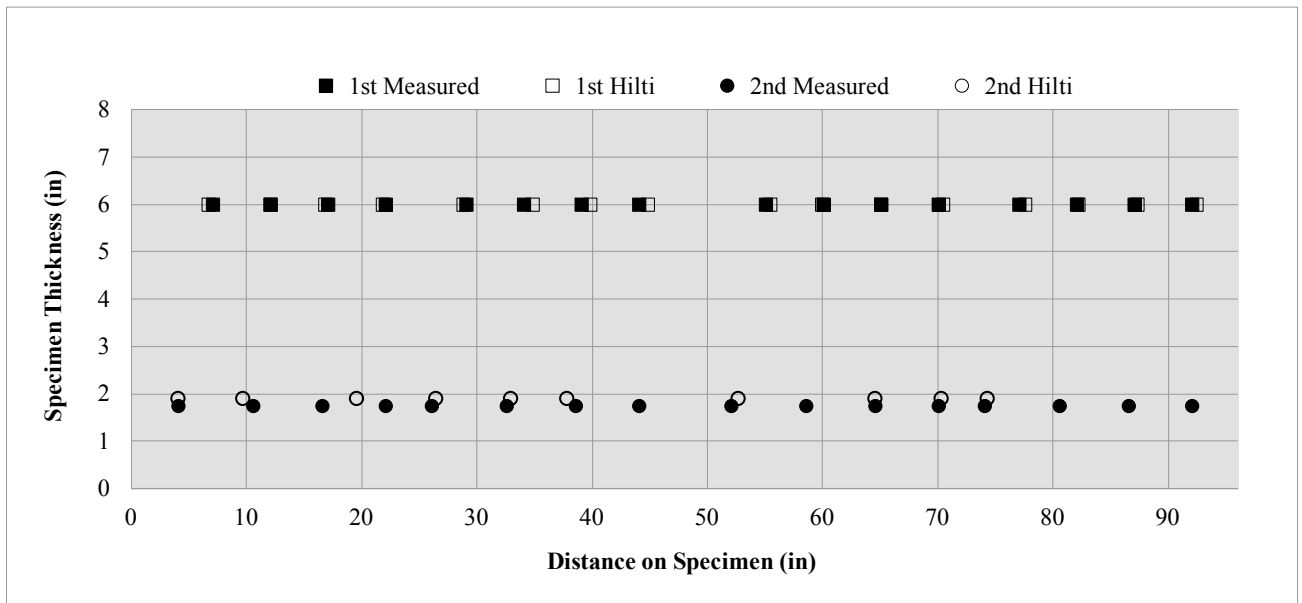

(a) Transverse Rebars

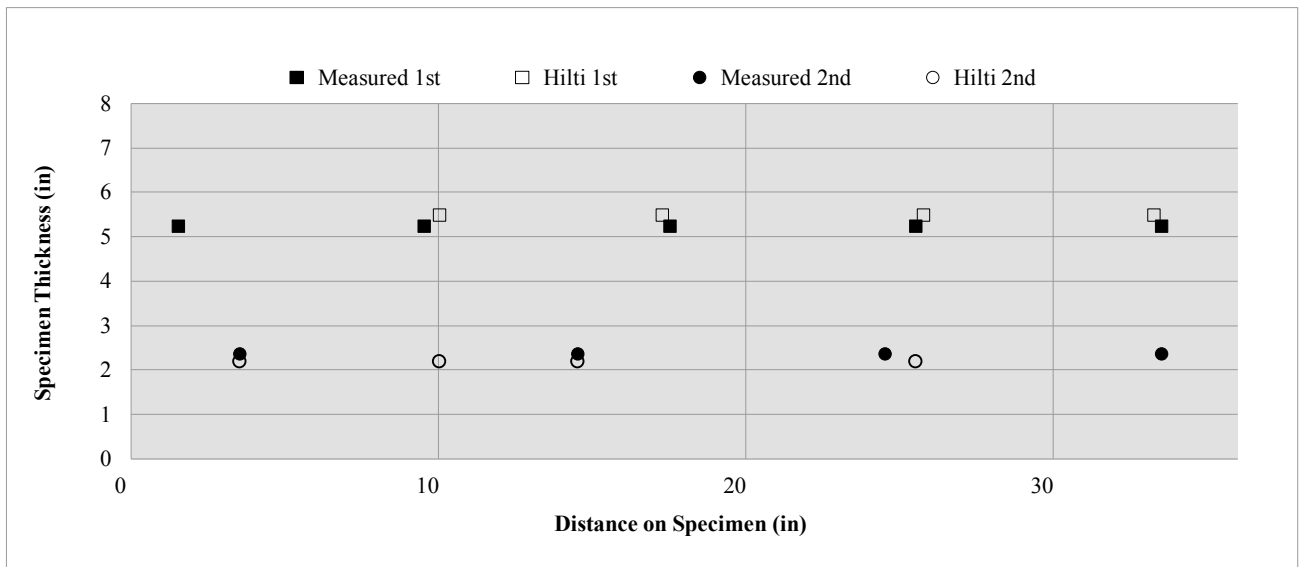

(b) Longitudinal Rebars

Figure 5.25. Hilti (PS1000) On-Site Results for 8-inch Thickness Reinforced Specimen Elevated.

9.5-inches Thickness Reinforced Specimen (Small Rebars)

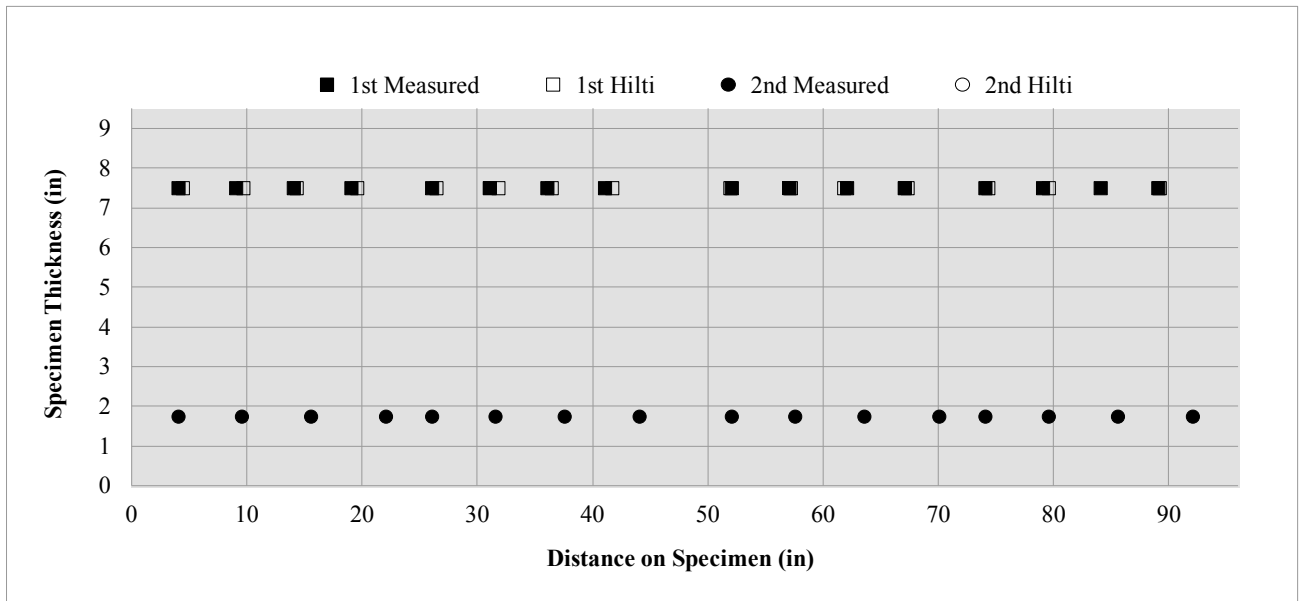

(a) Transverse Rebars

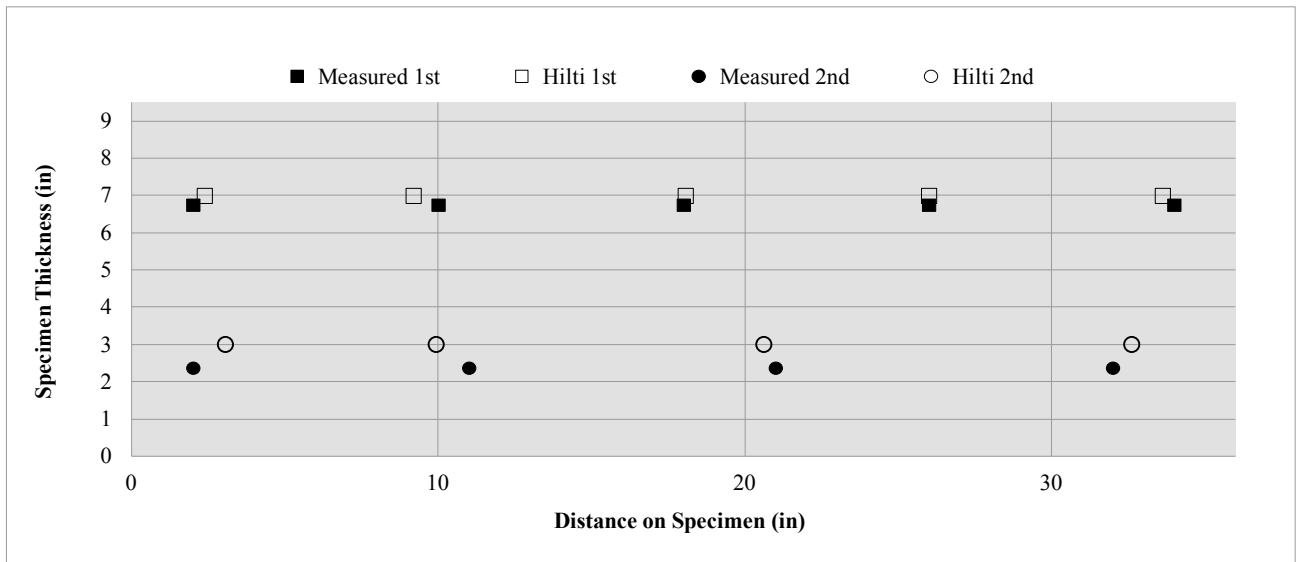

(b) Longitudinal Rebars

Figure 5.26. Hilti (PS1000) On-Site Results for 9.5-inch Thickness Reinforced Specimen (Small Rebars).

9.5-inches Thickness Reinforced Specimen (Big Rebars)

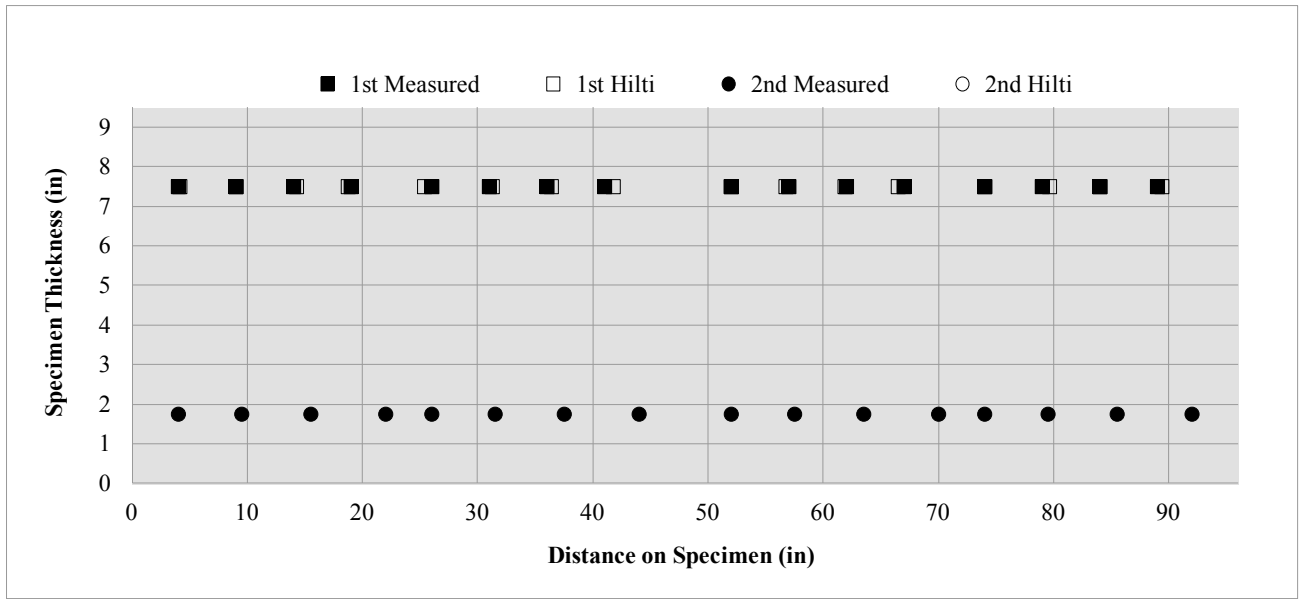

(a) Transverse Rebars

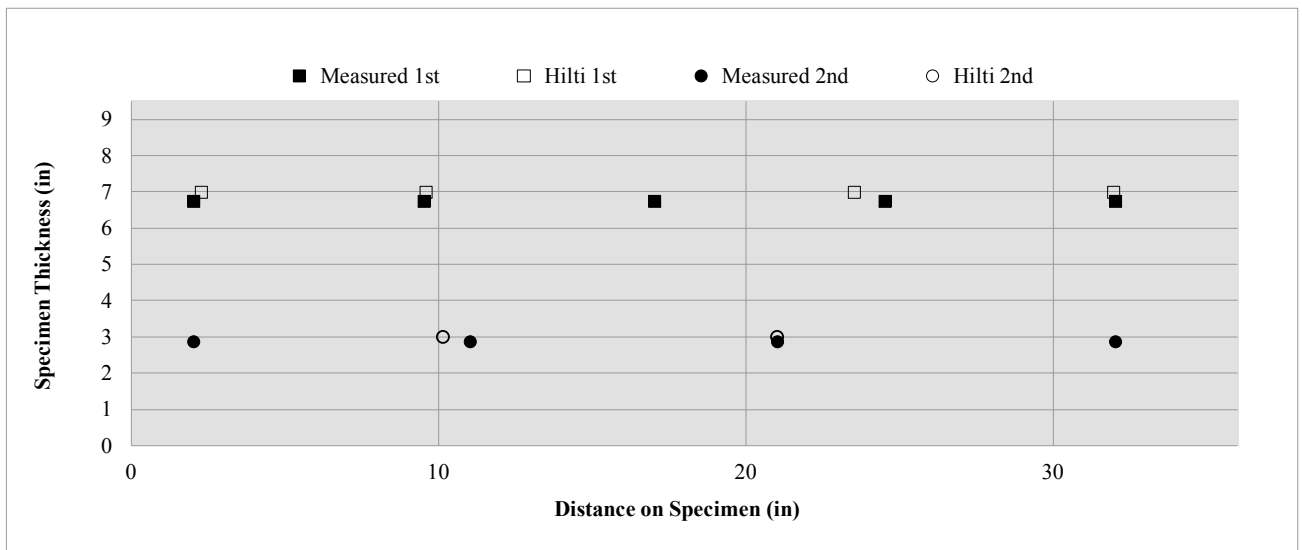

(b) Longitudinal Rebars

Figure 5.27. Hilti (PS1000) On-Site Results for 9.5-inch Thickness Reinforced Specimen (Big Rebars).

10-inches Thickness Reinforced Specimen

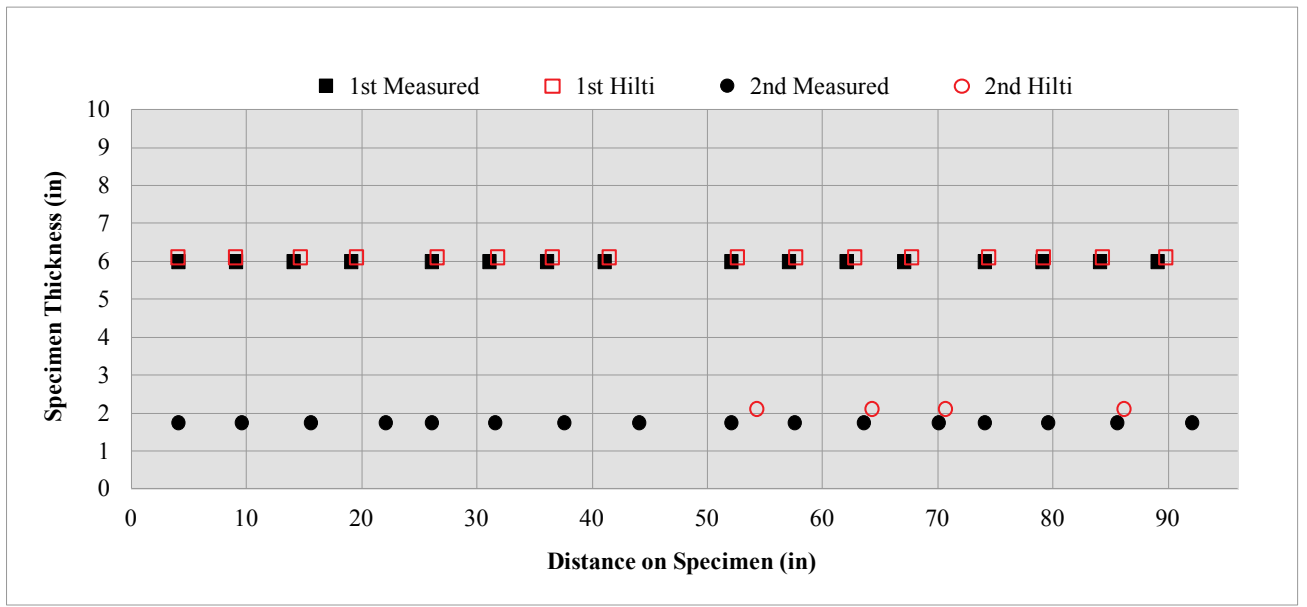

(a) Transverse Rebars

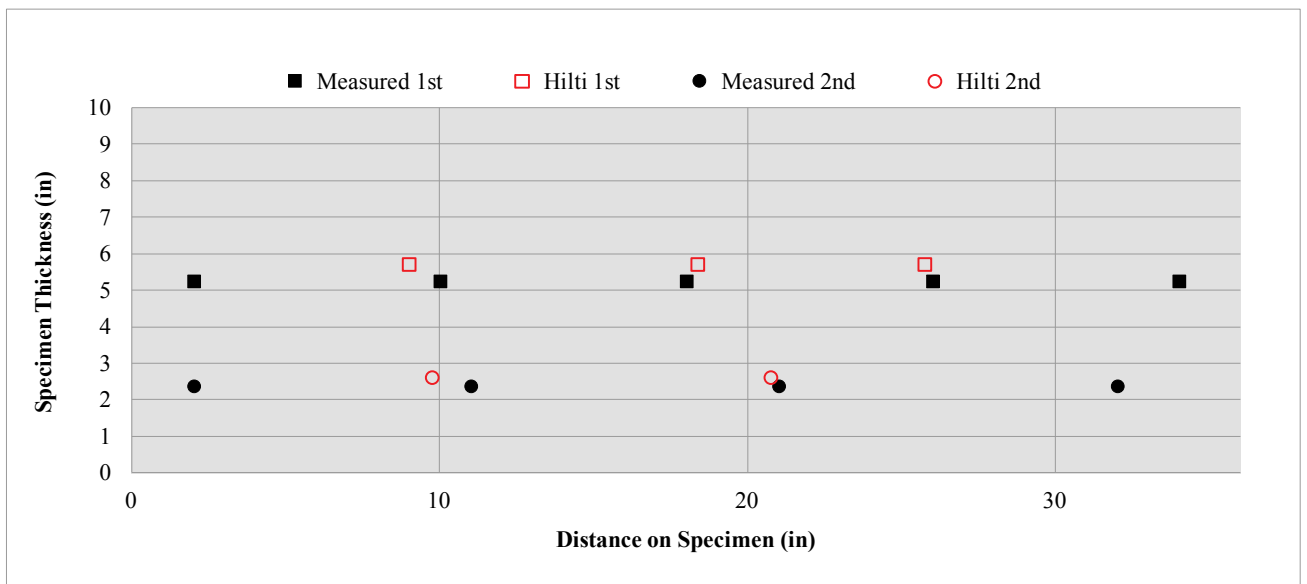

(b) Longitudinal Rebars

*Red measurements are referred to rebar positions for which it was not reported concrete coverage.

Figure 5.28. Hilti (PS1000) On-Site Results for 10-inch Thickness Reinforced Specimen.

10-inches Thickness Reinforced Specimen Elevated

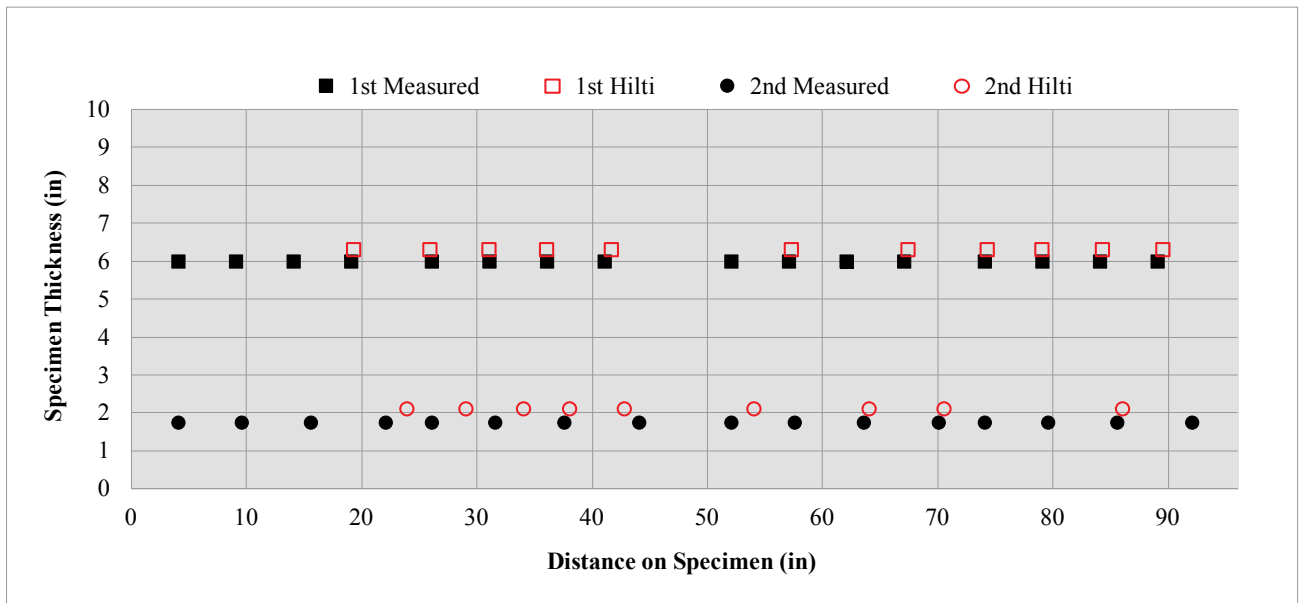

(a) Transverse Rebars

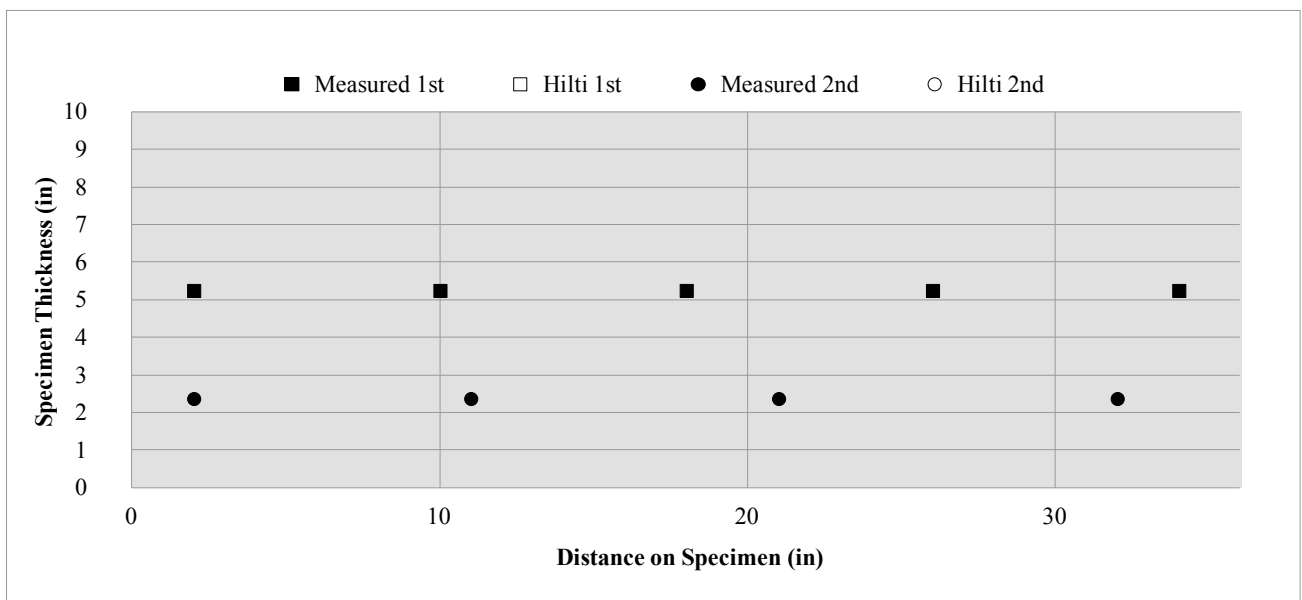

(b) Longitudinal Rebars

*Red measurements are referred to rebar positions for which it was not reported concrete coverage.

Figure 5.29. Hilti (PS1000) On-Site Results for 10-inch Thickness Reinforced Specimen Elevated.

Post-Processed Hilti Rebars Detection

Following, the rebars position determined after post processing the data collected with the GPR device from Hilti is illustrated for an effective comparison of the exact and estimated steel locations (Figures 5.30 to 5.43).

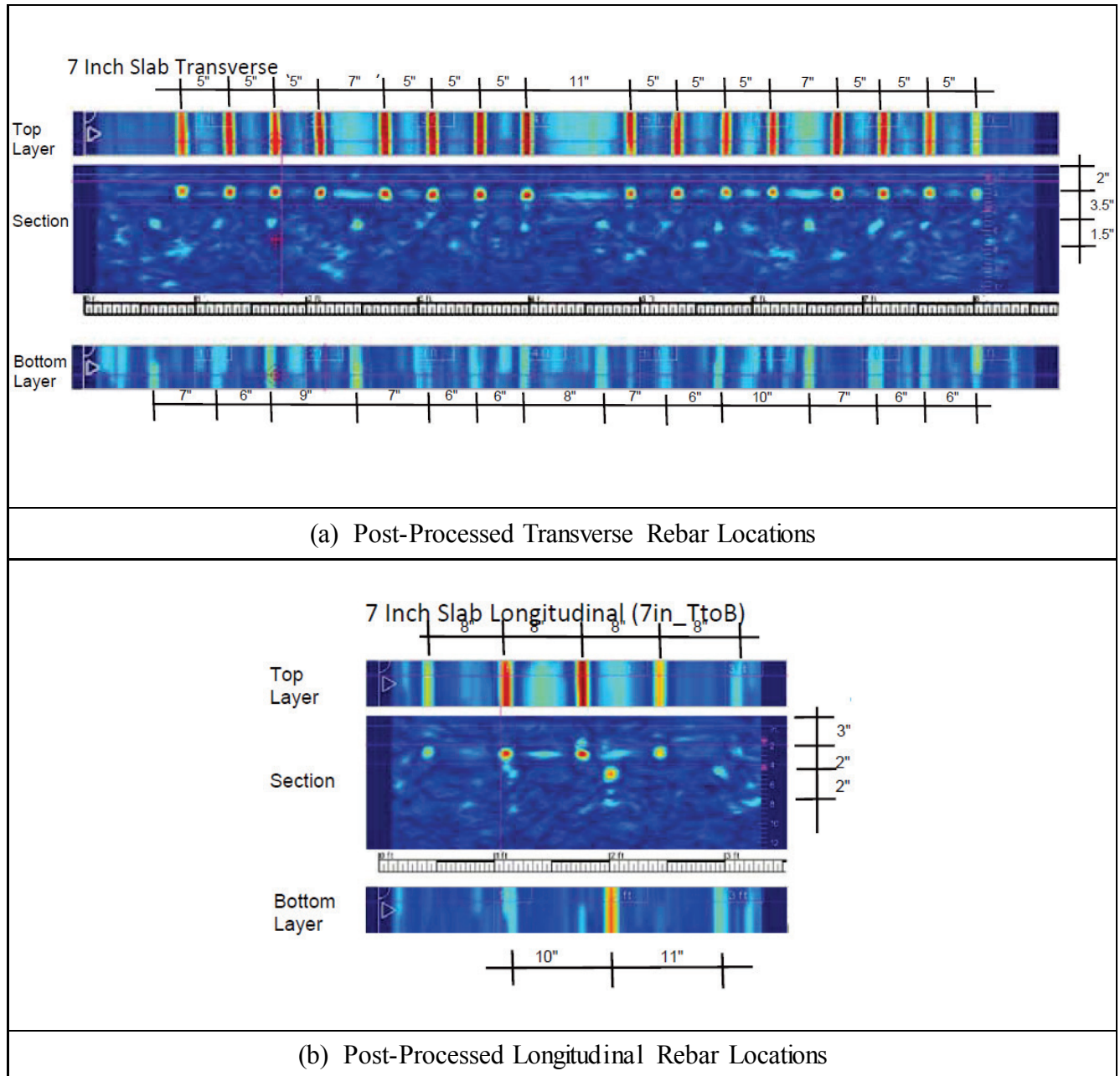
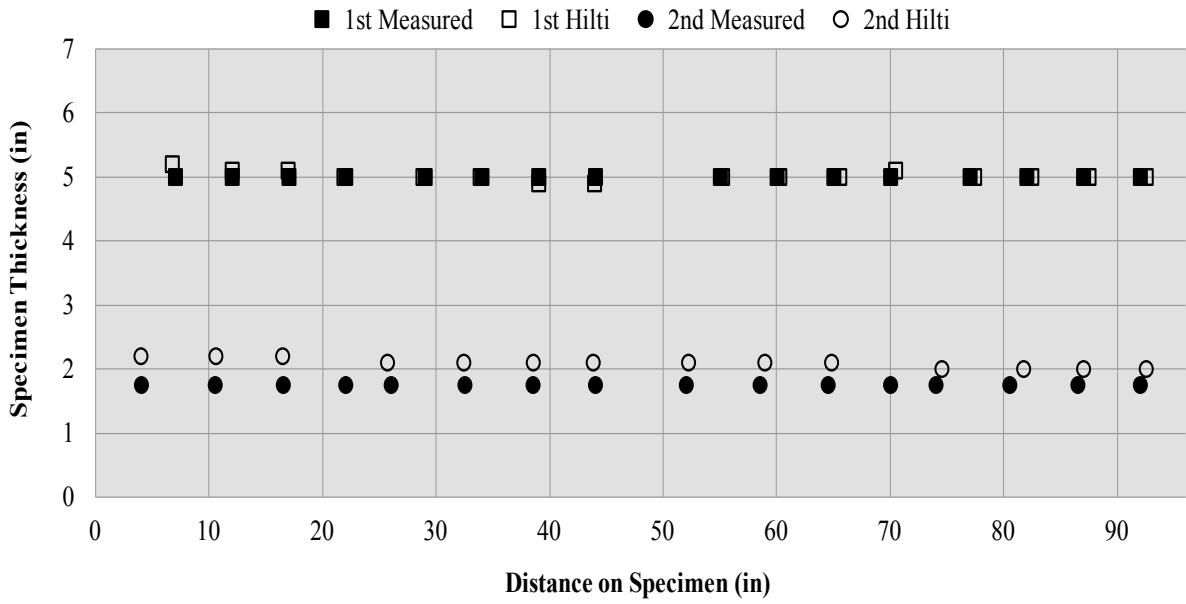
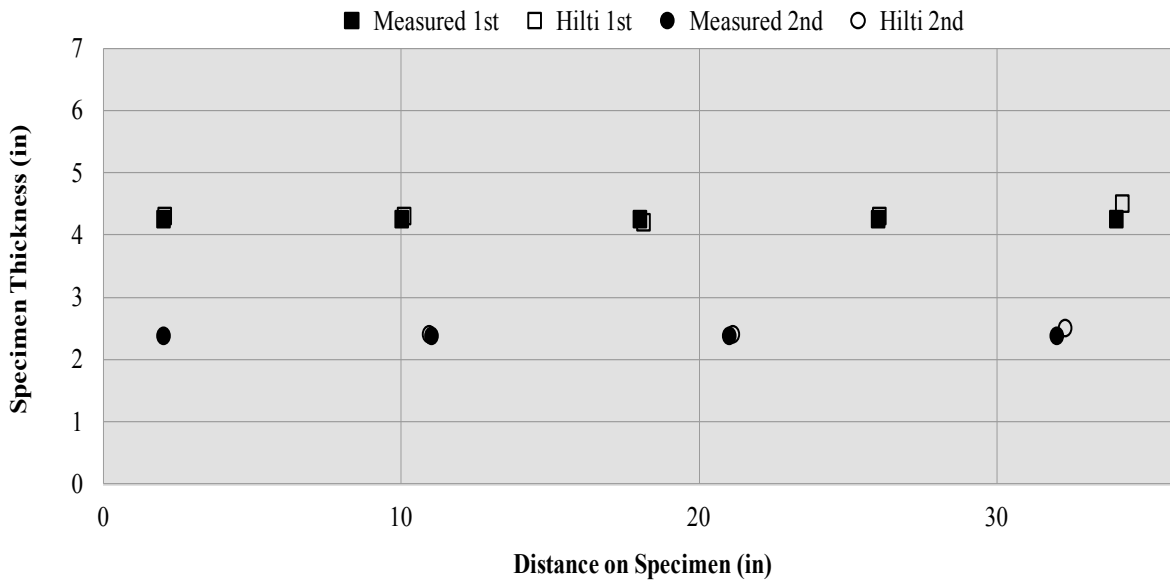

Figure 5.30. Hilti Screenshots From Post-Processed Data of 7-inch Thick Block Results.

7-inches Thickness Reinforced Specimen



(a) Transverse Rebars



(b) Longitudinal Rebars

Figure 5.31. Hilti Post-processed Results for 7-inch Thickness Reinforced Specimen.

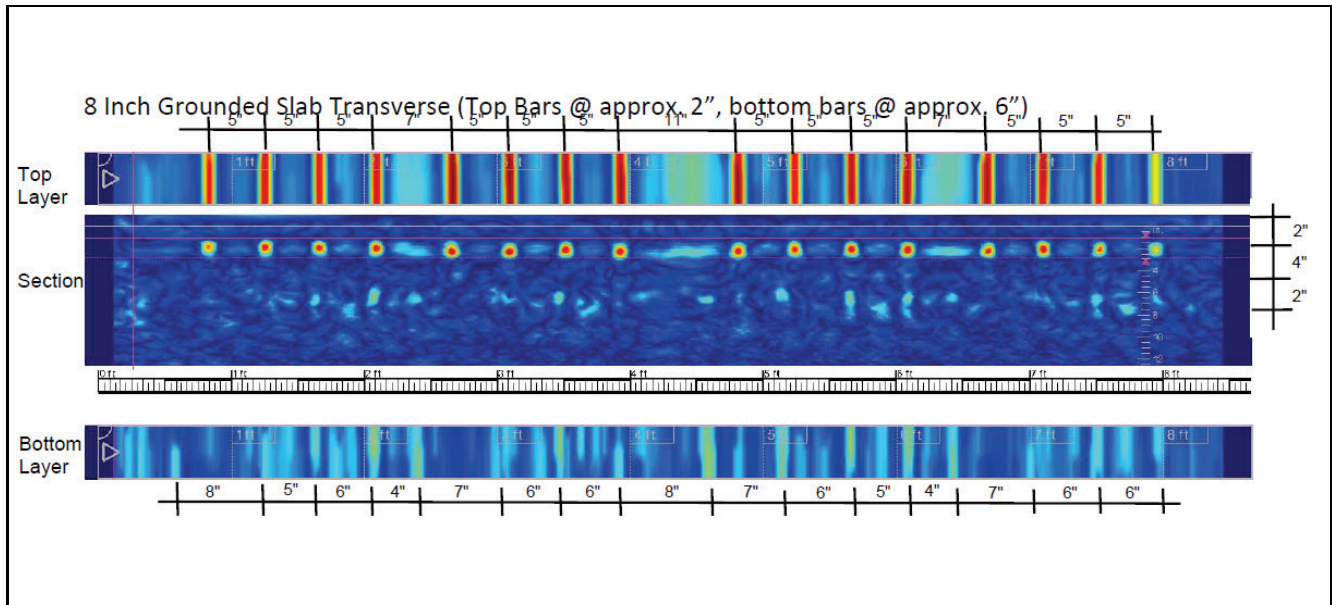

(a) Post-Processed Transverse Rebar Locations

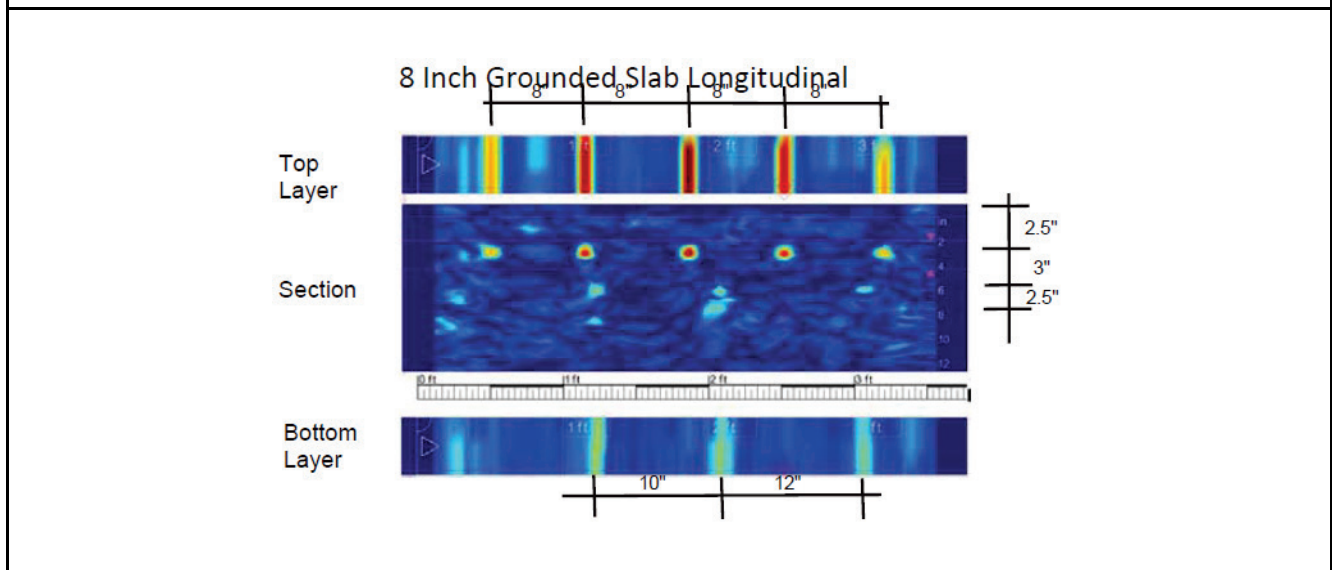

(b) Post-Processed Longitudinal Rebar Locations

Figure 5.32. Hilti Screenshots From Post-Processed Data of 8-inch Thick Block Results.

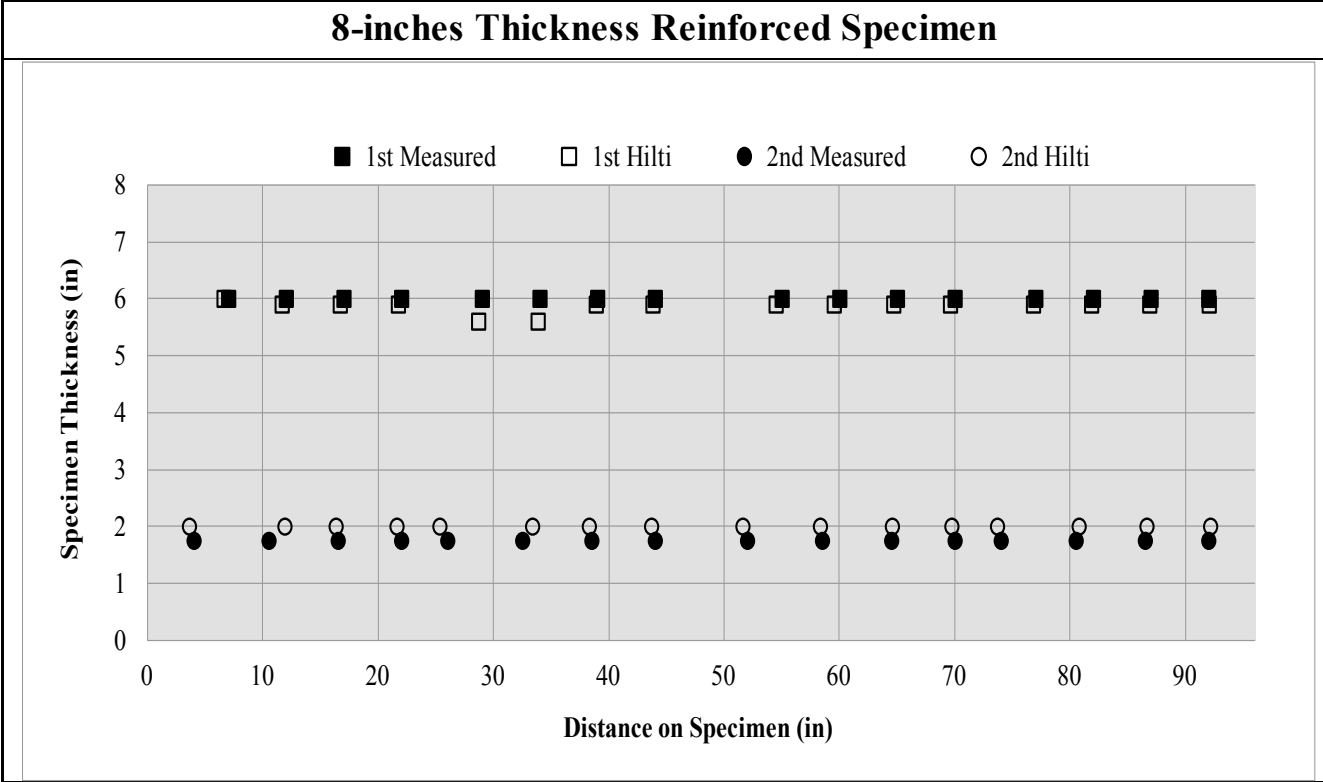

(a) Transverse Rebars

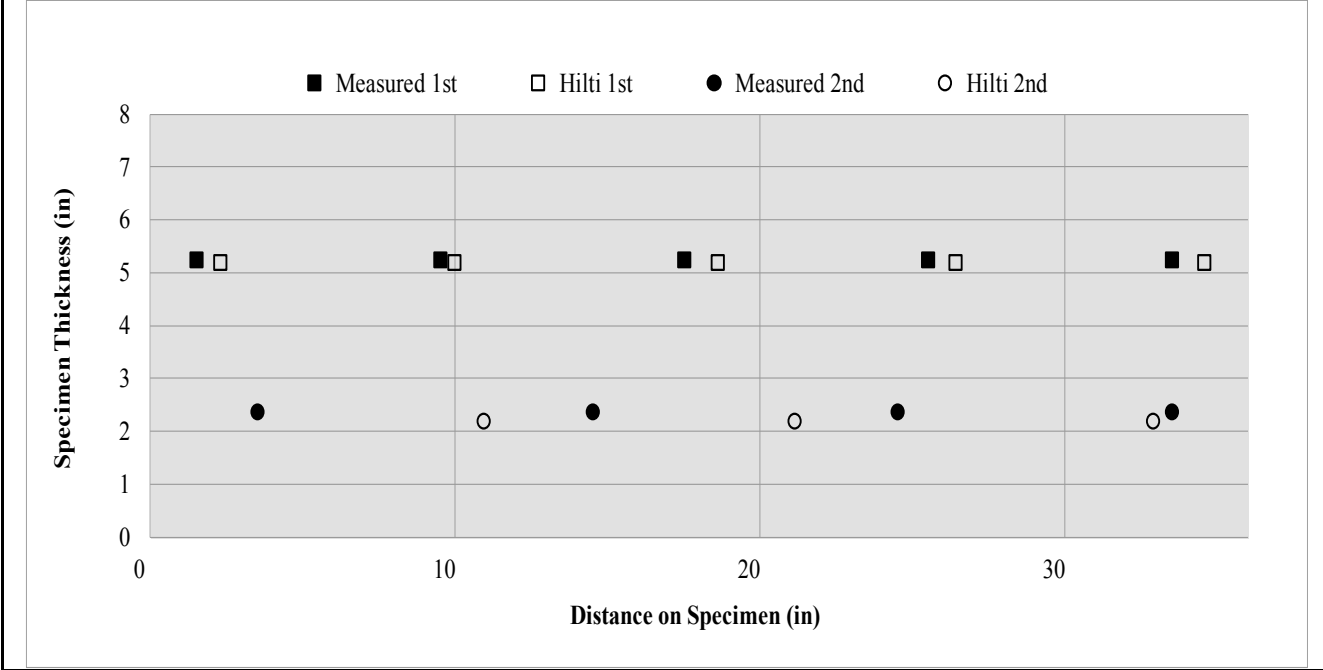

(b) Longitudinal Rebars

Figure 5.33. Hilti Post-processed Results for 8-inch Thickness Reinforced Specimen.

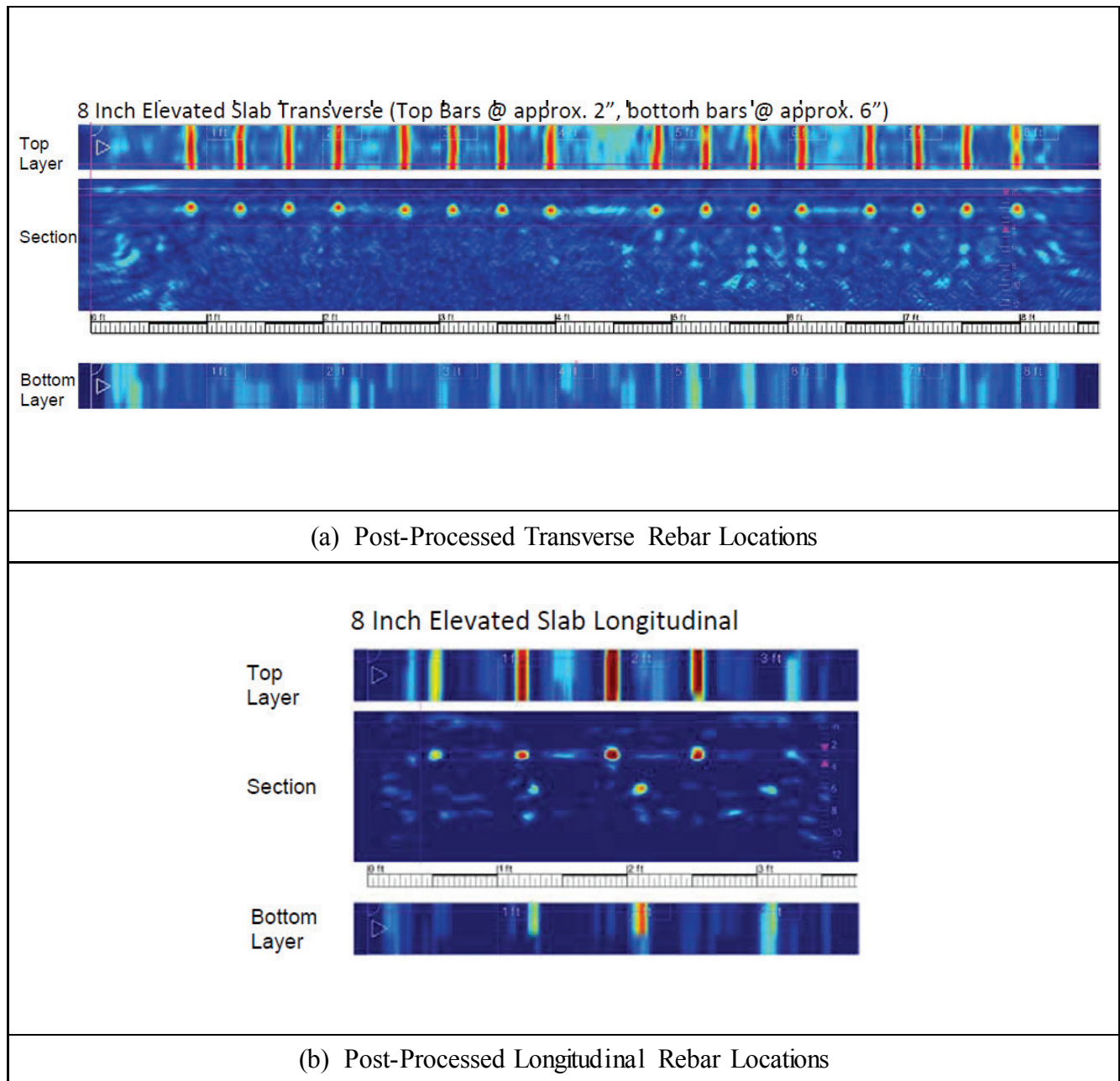
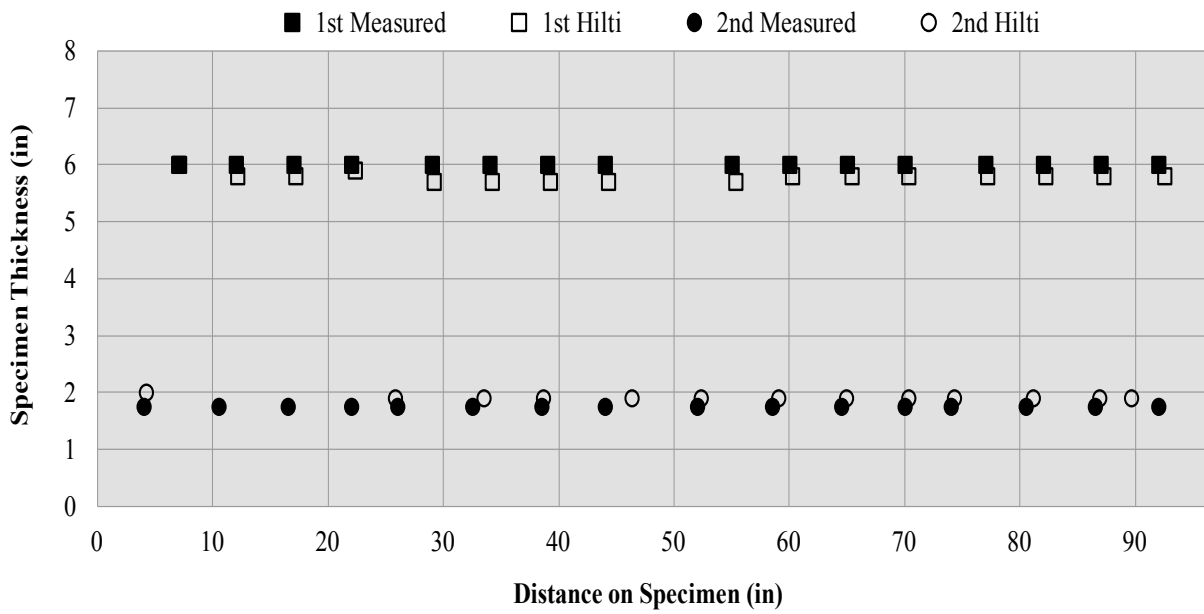
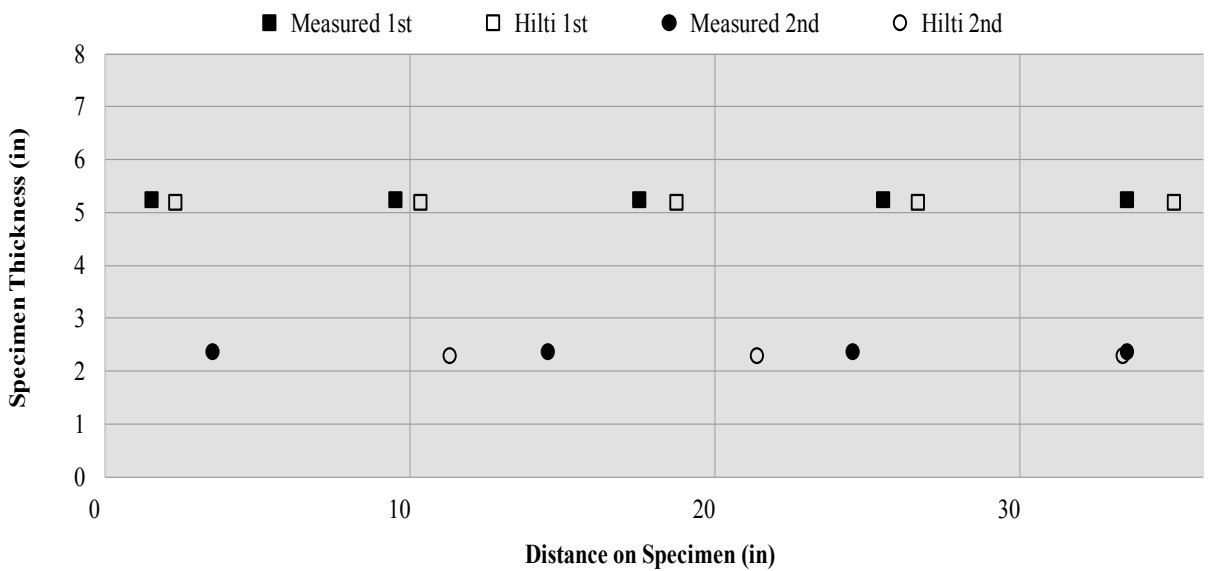

Figure 5.34. Hilti Screenshots From Post-Processed Data of 8-inch Thick Elevated Block Results.

8-inches Thickness Reinforced Specimen Elevated



(a) Transverse Rebars



(b) Longitudinal Rebars

Figure 5.35. Hilti Post-processed Results for 8-inch Thickness Reinforced Specimen Elevated.

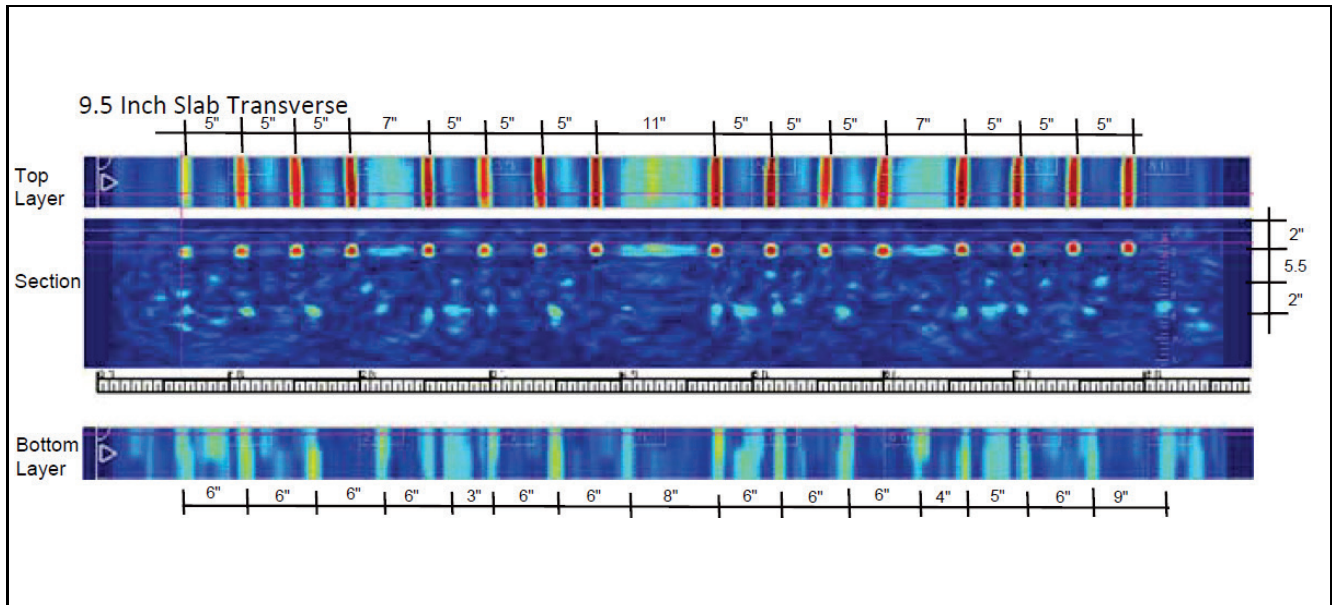

(a) Post-Processed Transverse Rebar Locations

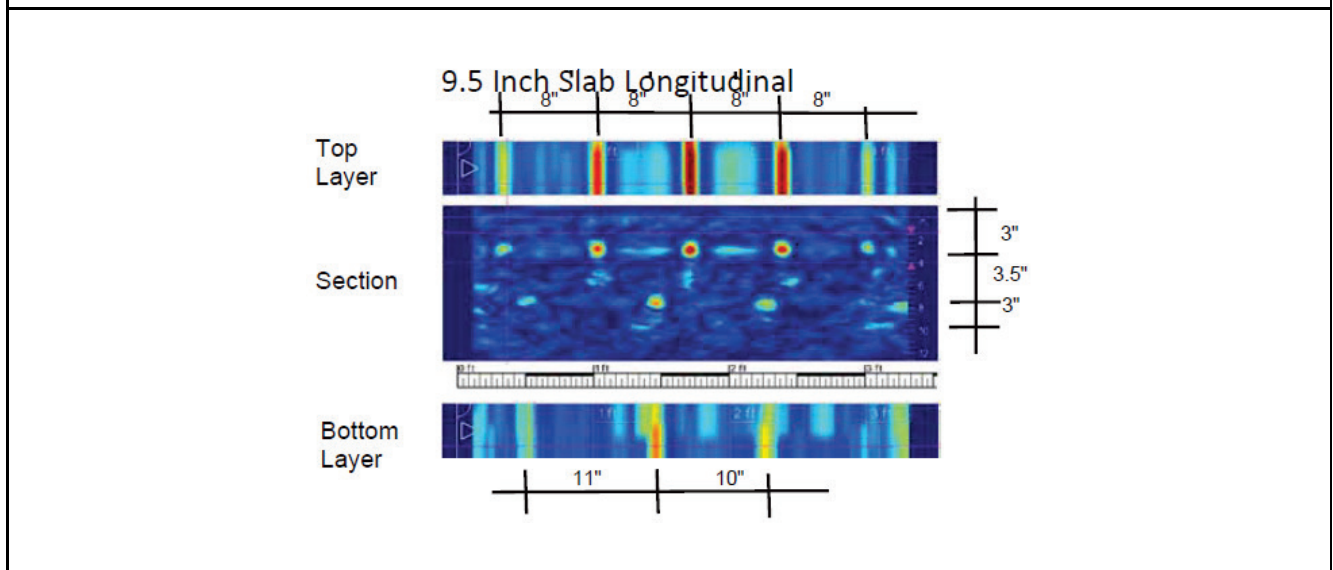

(b) Post-Processed Longitudinal Rebar Locations

Figure 5.36. Hilti Screenshots From Post-Processed Data of 9.5-inch Thick Block Results (Small Rebars).

9.5-inches Thickness Reinforced Specimen (Small Rebars)

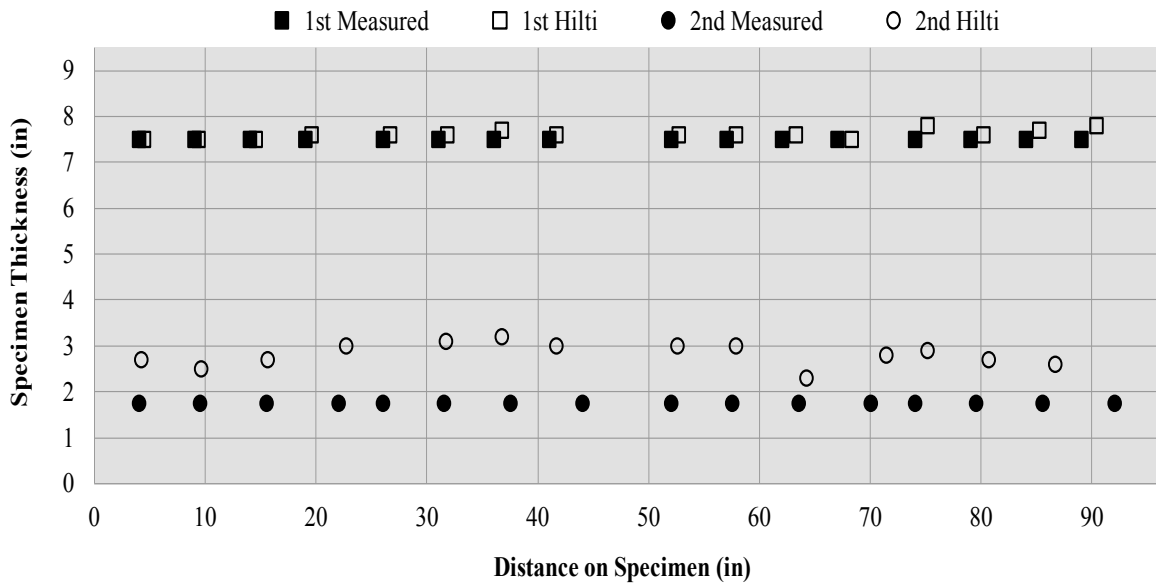

(a) Transverse Rebars

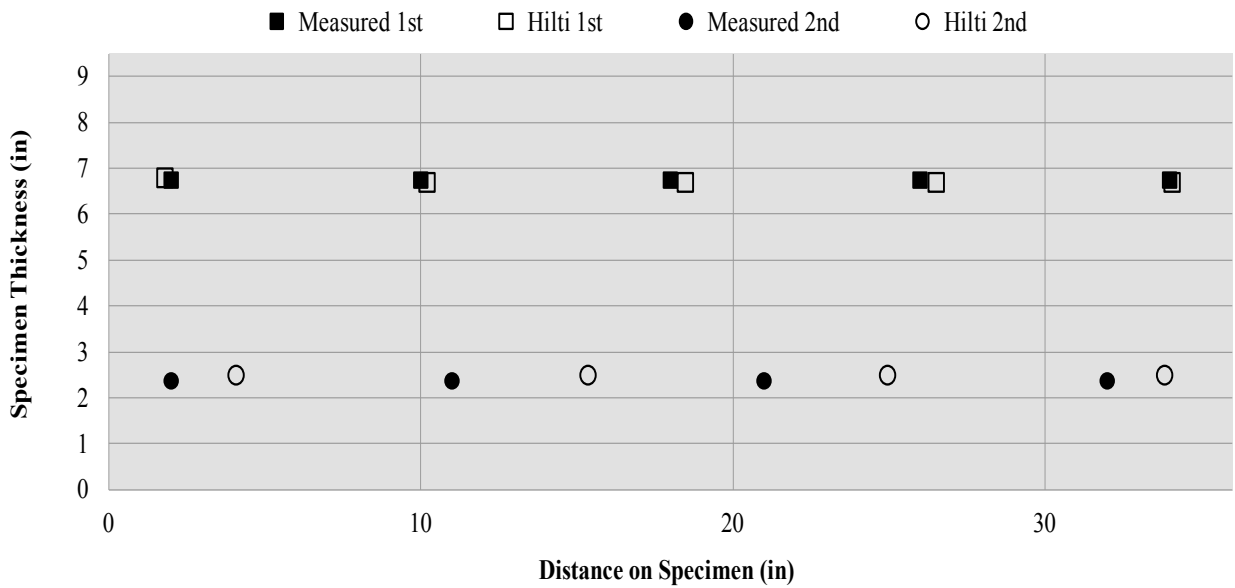

(b) Longitudinal Rebars

Figure 5.37. Hilti Post-processed Results for 9.5-inch Thickness Reinforced Specimen (Small Rebars).

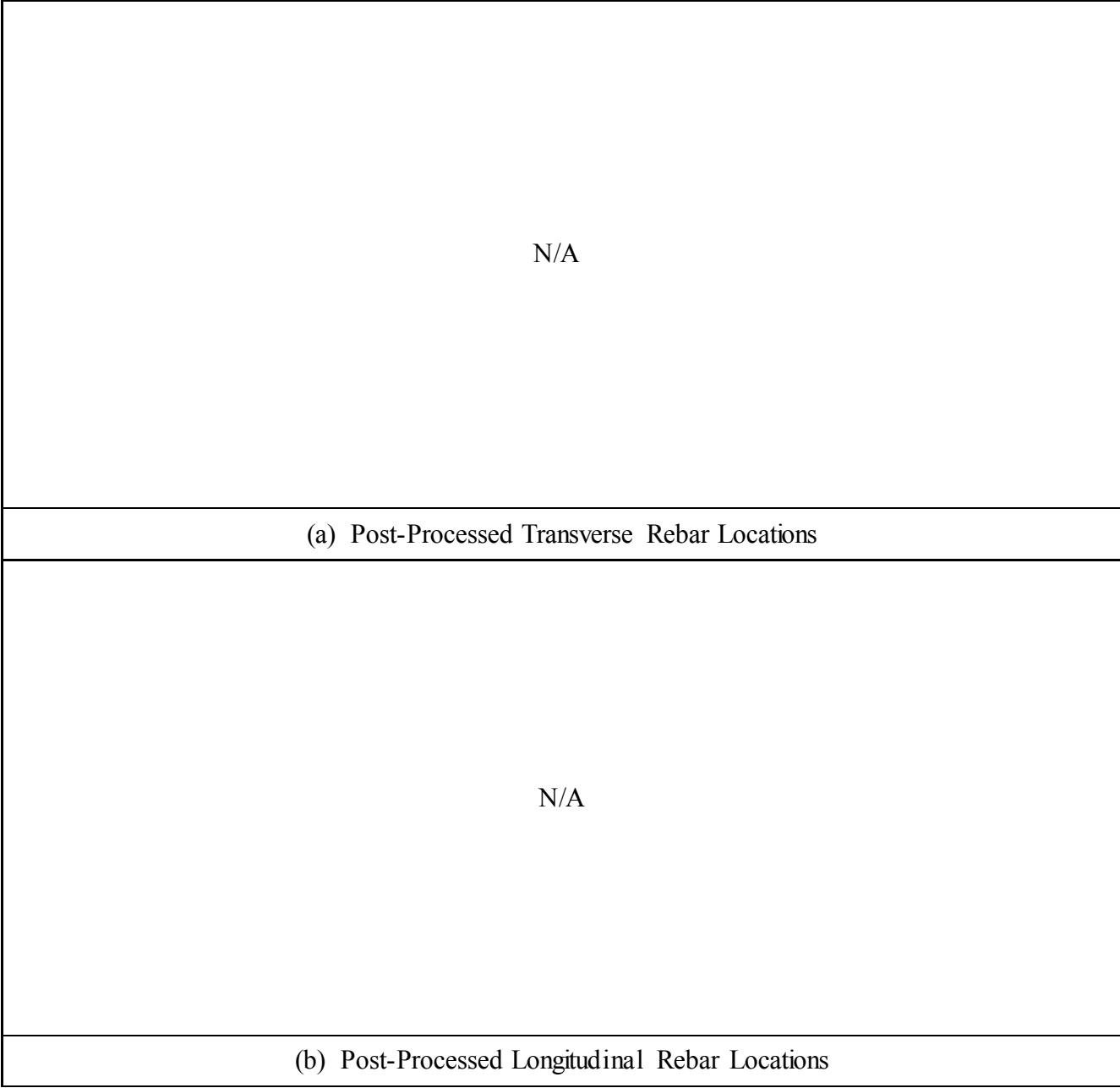
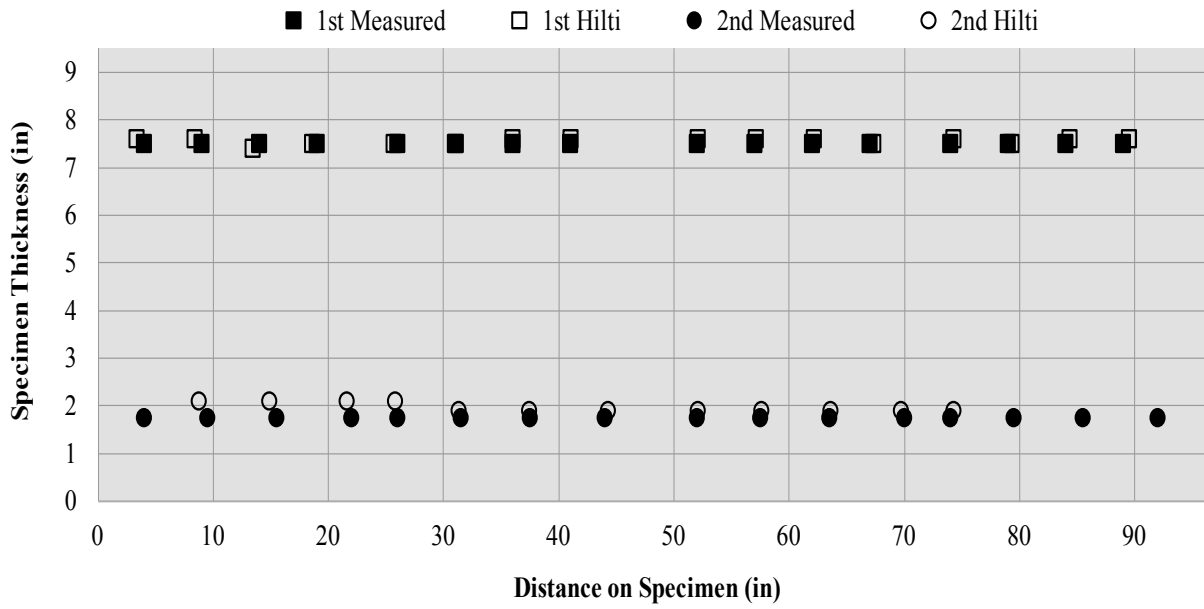
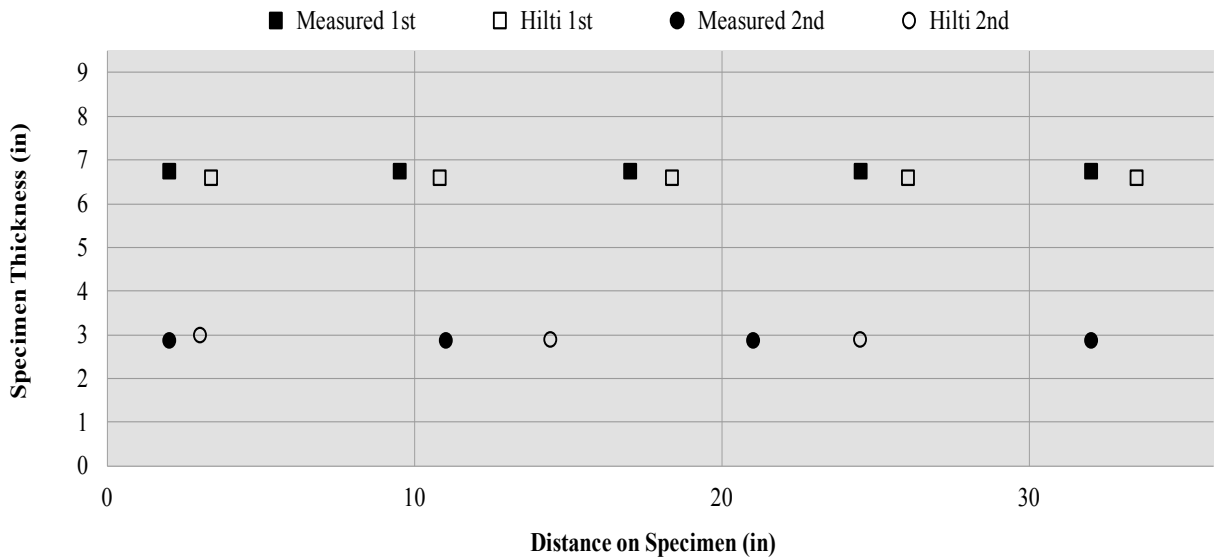

Figure 3.38. Hilti Screenshots From Post-Processed Data of 9.5-inch Thick Block Results (Big Rebars).

9.5-inches Thickness Reinforced Specimen (Big Rebars)



(a) Transverse Rebars



(b) Longitudinal Rebars

Figure 5.39. Hilti Post-processed Results for 9.5-inch Thickness Reinforced Specimen (Big Rebars).

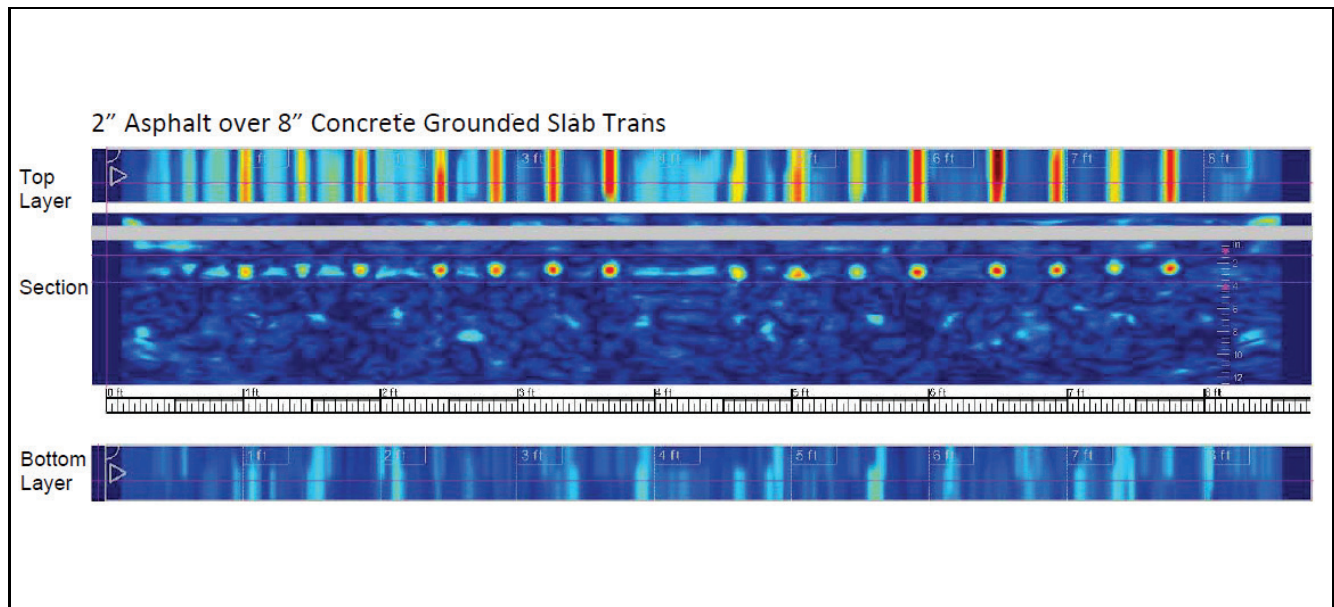

(a) Post-Processed Transverse Rebar Locations

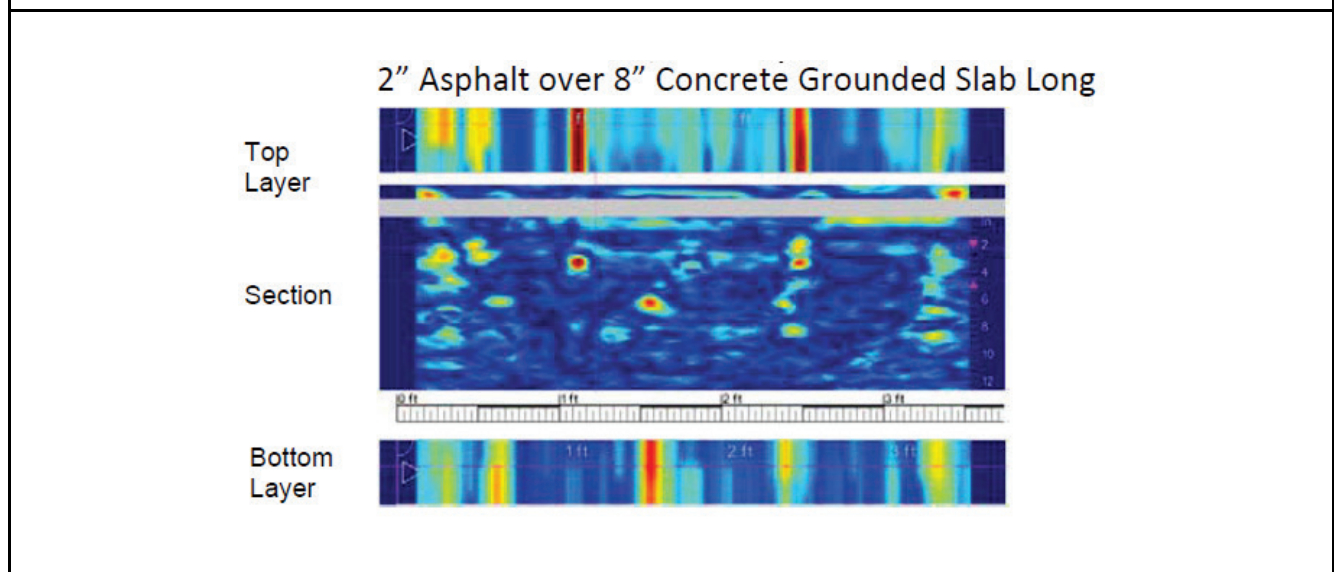

(b) Post-Processed Longitudinal Rebar Locations

Figure 5.40. Hilti Screenshots From Post-Processed Data of 10-inch Thick Block Results.

10-inches Thickness Reinforced Specimen

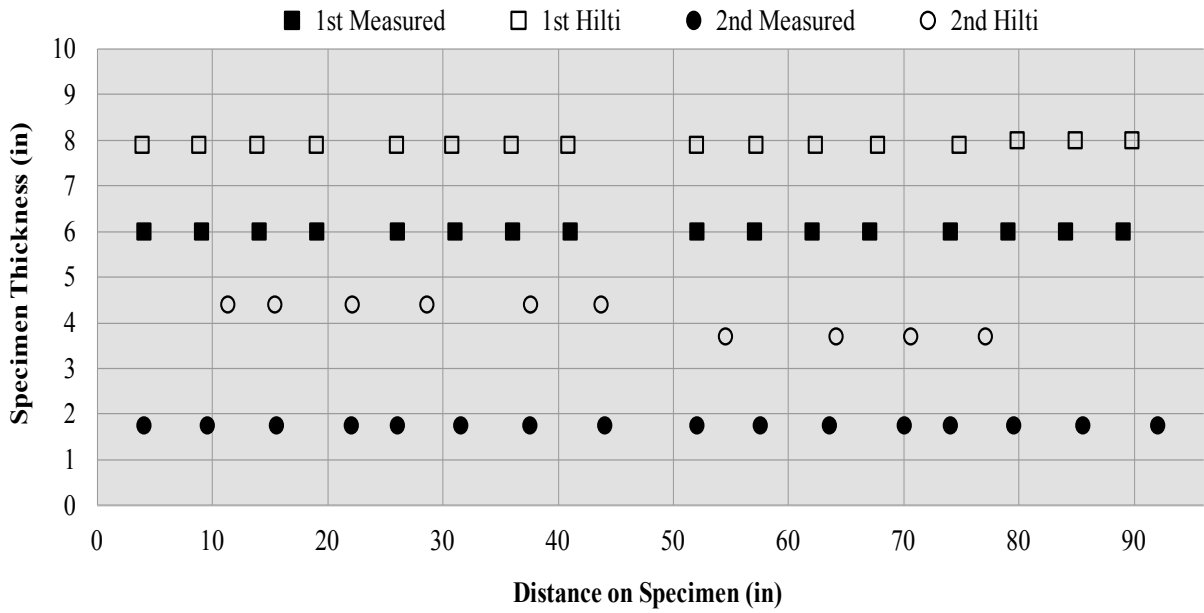

(a) Transverse Rebars

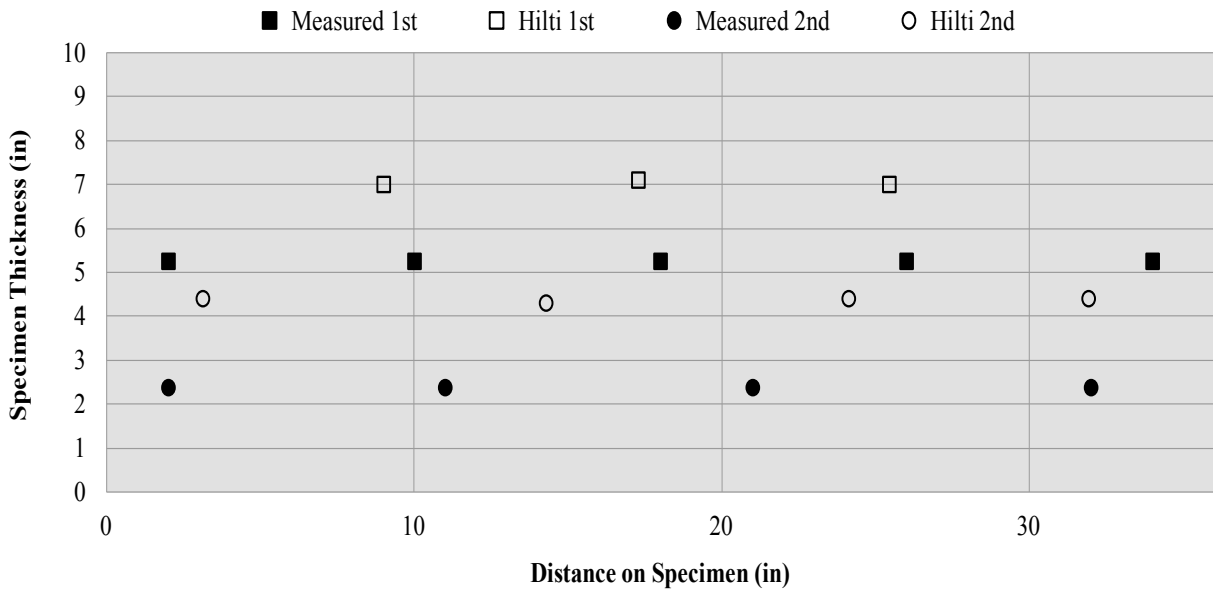

(b) Longitudinal Rebars

Figure 5.41. Hilti Post-processed Results for 10-inch Thickness Reinforced Specimen.

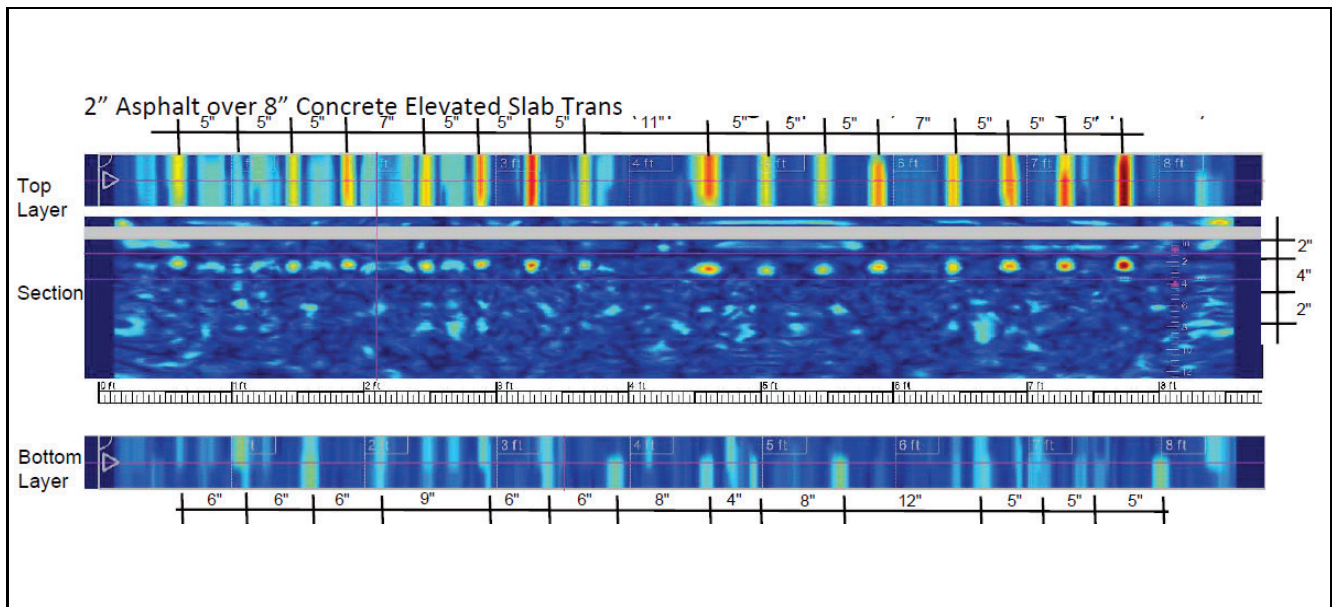

(a) Post-Processed Transverse Rebar Locations

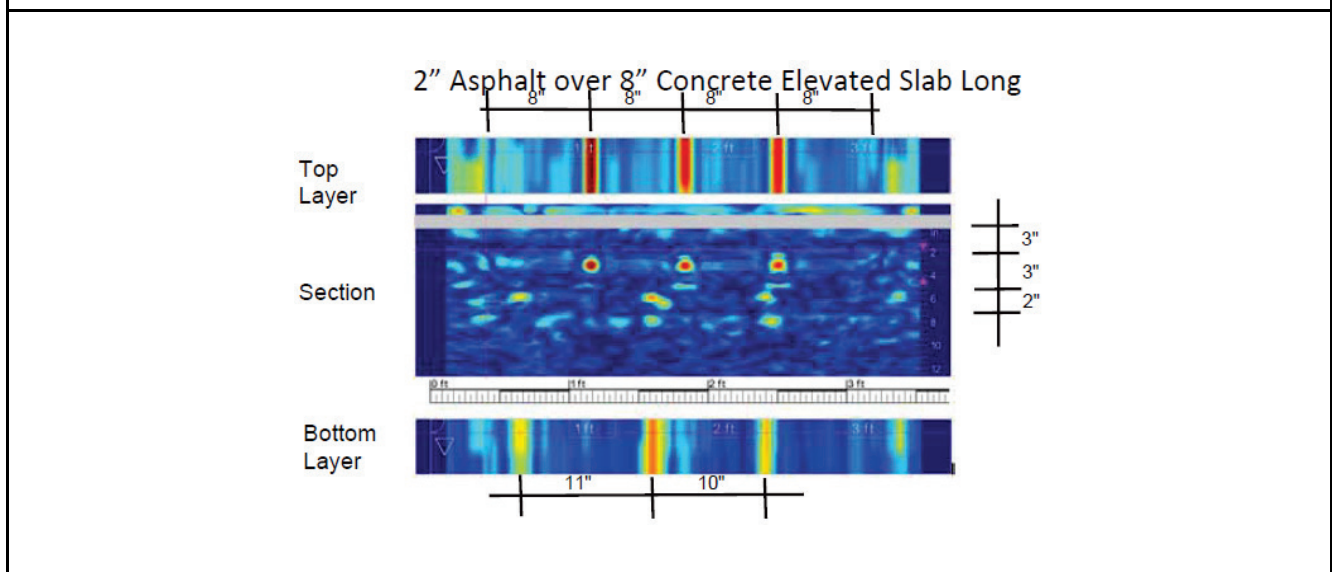

(b) Post-Processed Longitudinal Rebar Locations

Figure 5.42. Hilti Screenshots From Post-Processed Data of 10-inch Thick Elevated Block Results.

10-inches Thickness Reinforced Specimen Elevated

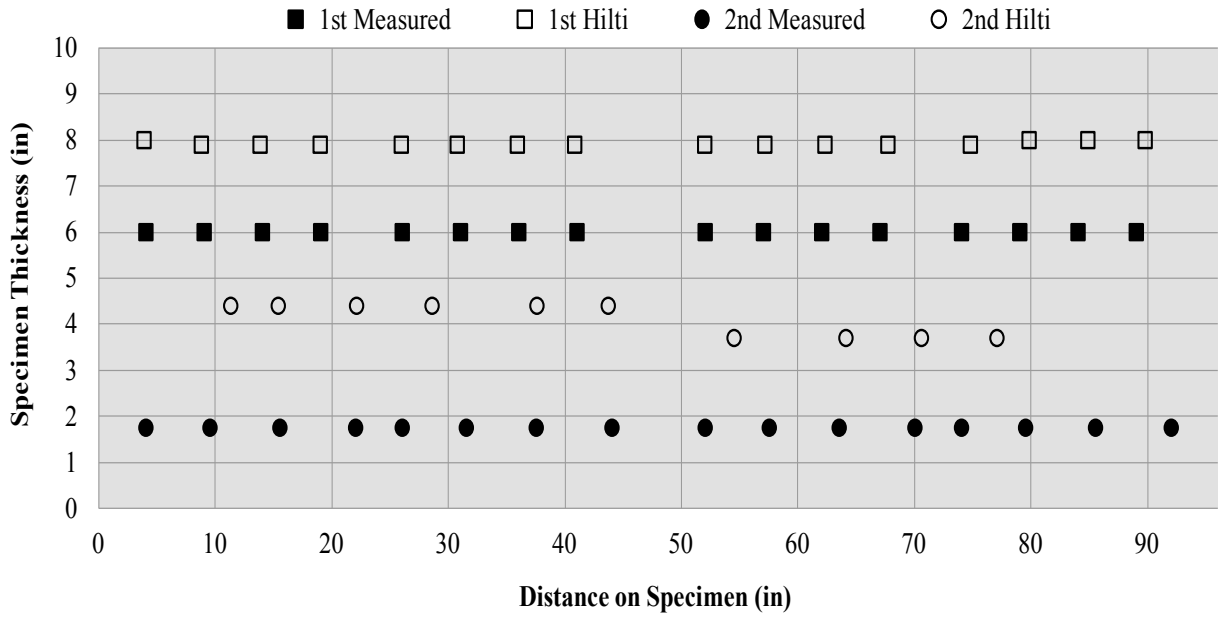

(a) Transverse Rebars

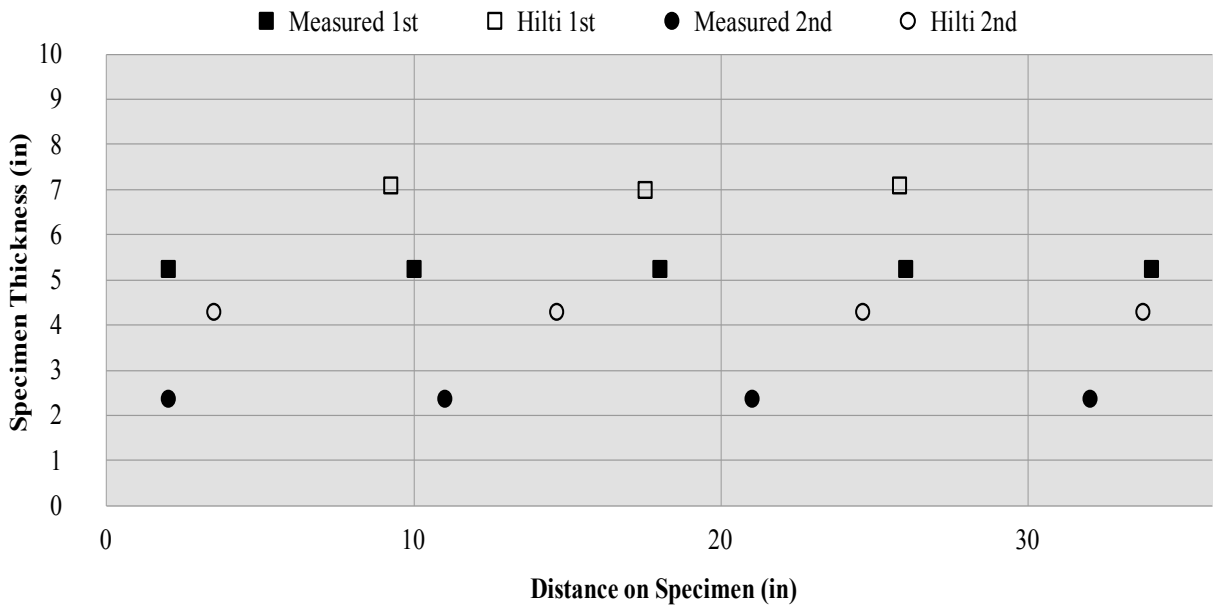

(b) Longitudinal Rebars

Figure 5.43. Hilti Post-processed Results for 10-inch Thickness Reinforced Specimen Elevated.

JRC/Proceq Results

On-Site Rebars JRC/Proceq Detection

The Handy Search device radiates electromagnetic waves through the concrete surface and catches reflected waves from embedded objects that have different electrical characteristics than concrete (for example, steel rebars). Object location and depth are then recorded and displayed as simple image data. The device reveals images of the cross section of the concrete structure in a direction that intersects the search target perpendicularly. The cross section of an object such as a reinforcing steel bar will be displayed as an angular image (Figures 5.44 and 5.45). More details on the characteristics and use of the JRC/Proceq GPR device are reported in Appendix I.

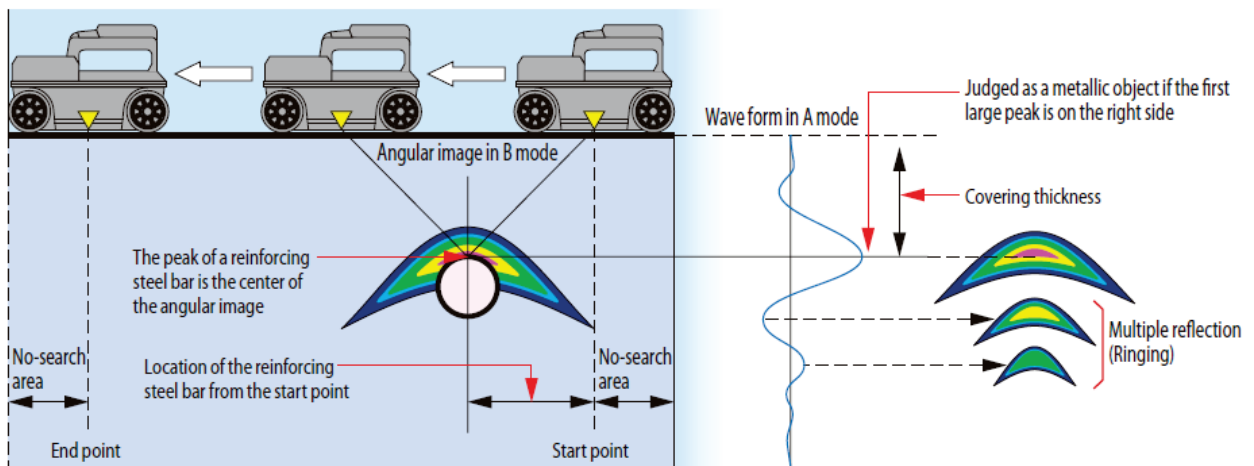

Figure 5.44. Handy Search Graphical Representation of the Displayed Angular Image Resulting from Locating a Reinforced Steel Bar in Concrete (Proceq, 2012).

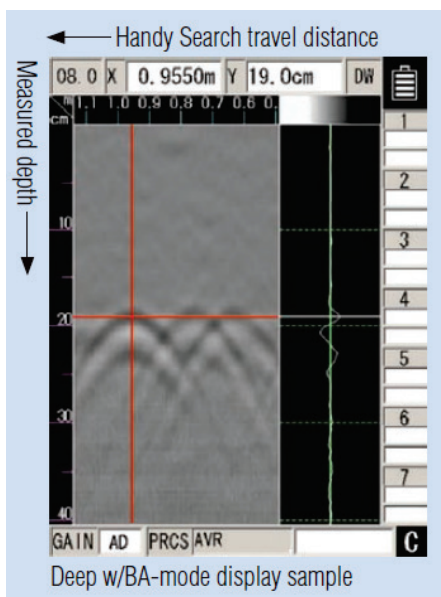

Figure 5.45. Handy Search Scan Screen Example (During Scanning).

Figures 5.46 to 5.52 show the results obtained from the reinforced concrete specimens scanning with the Handy Search from JRC. Each figure reports the measured exact position of the steel reinforcement from the first and second layer in each slab. Also, the rebars positions determined by the GPR device from JRC on site measurements are illustrated for an effective comparison of the exact and estimated steel locations.

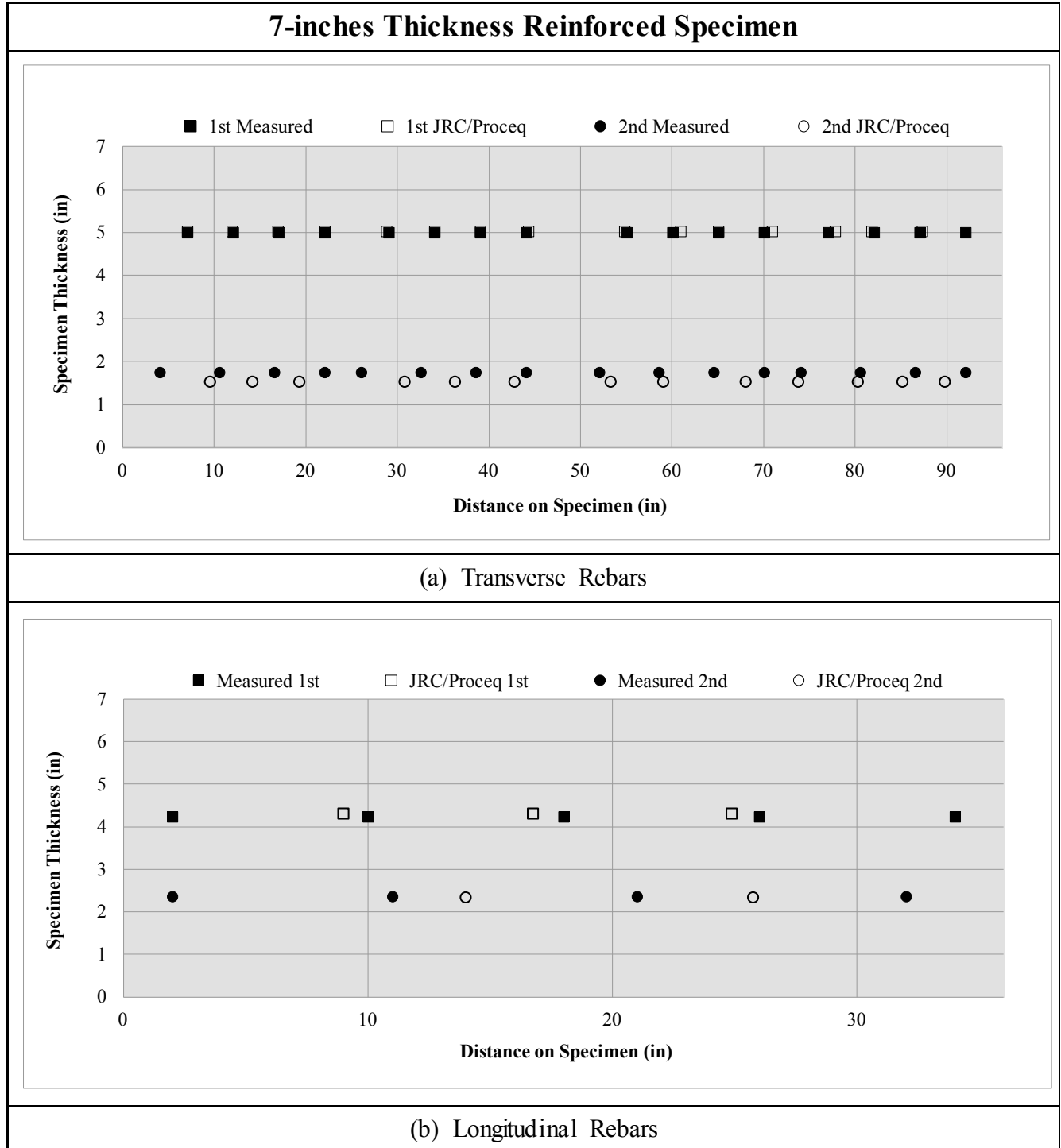
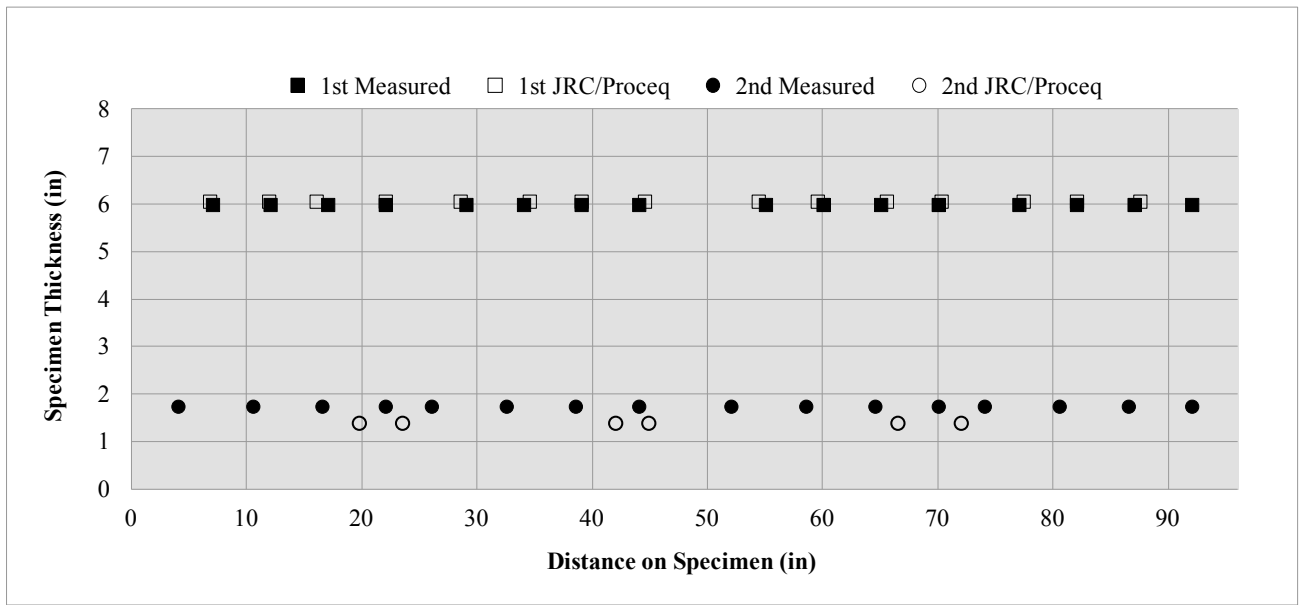
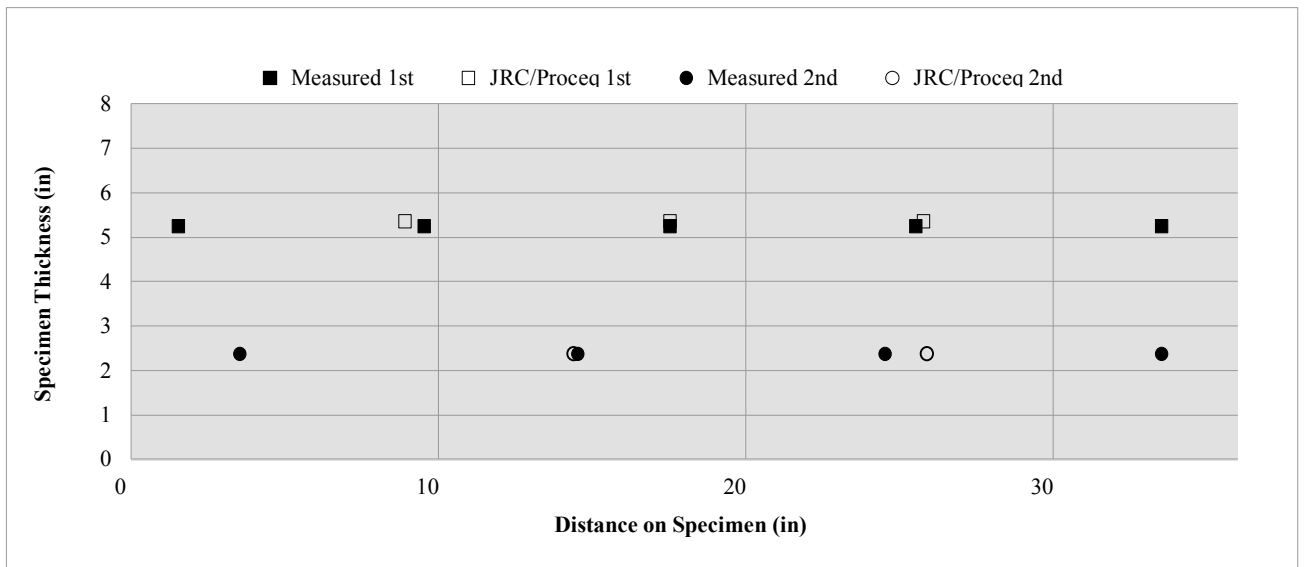

Figure 5.46. JRC/Proceq On-Site Results for 7-inch Thickness Reinforced Specimen.

8-inches Thickness Reinforced Specimen



(a) Transverse Rebars



(b) Longitudinal Rebars

Figure 5.47. JRC/Proceq On-Site Results for 8-inch Thickness Reinforced Specimen.

8-inches Thickness Reinforced Specimen Elevated

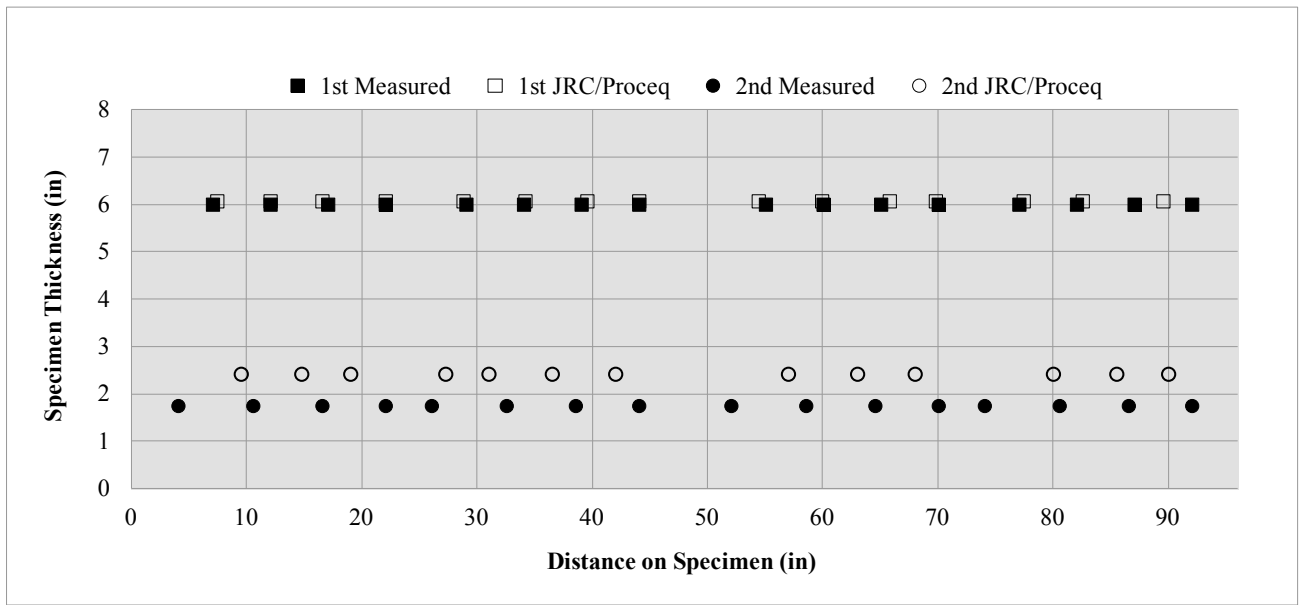

(a) Transverse Rebars

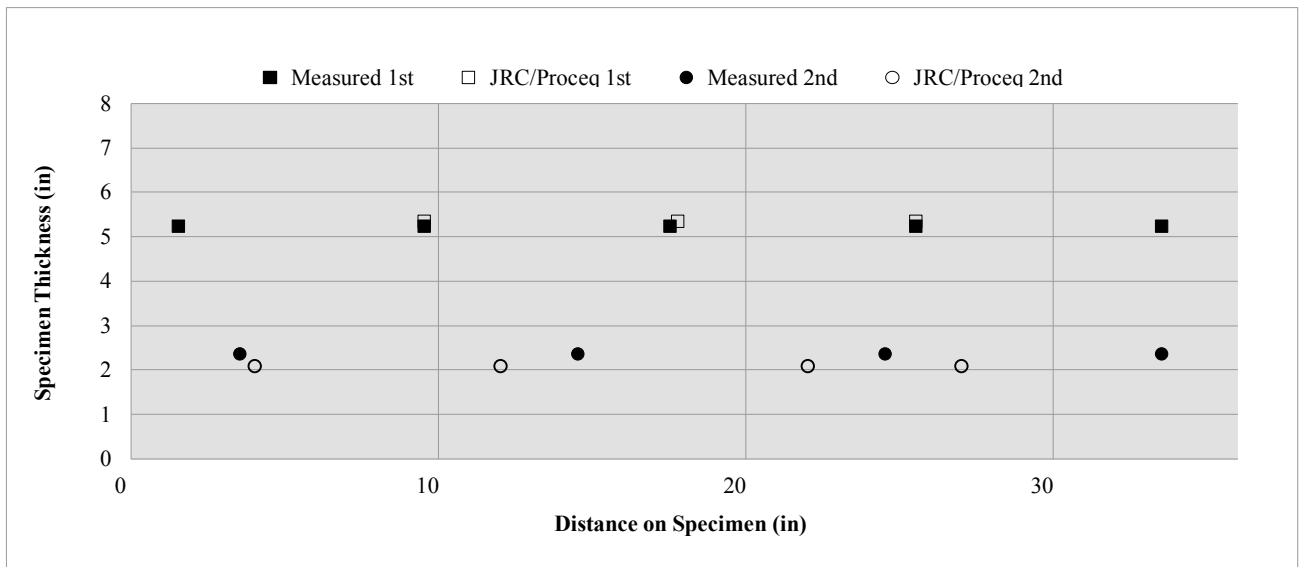

(b) Longitudinal Rebars

Figure 5.48. JRC/Proceq On-Site Results for 8-inch Thickness Reinforced Specimen Elevated.

9.5-inches Thickness Reinforced Specimen (Small Rebars)

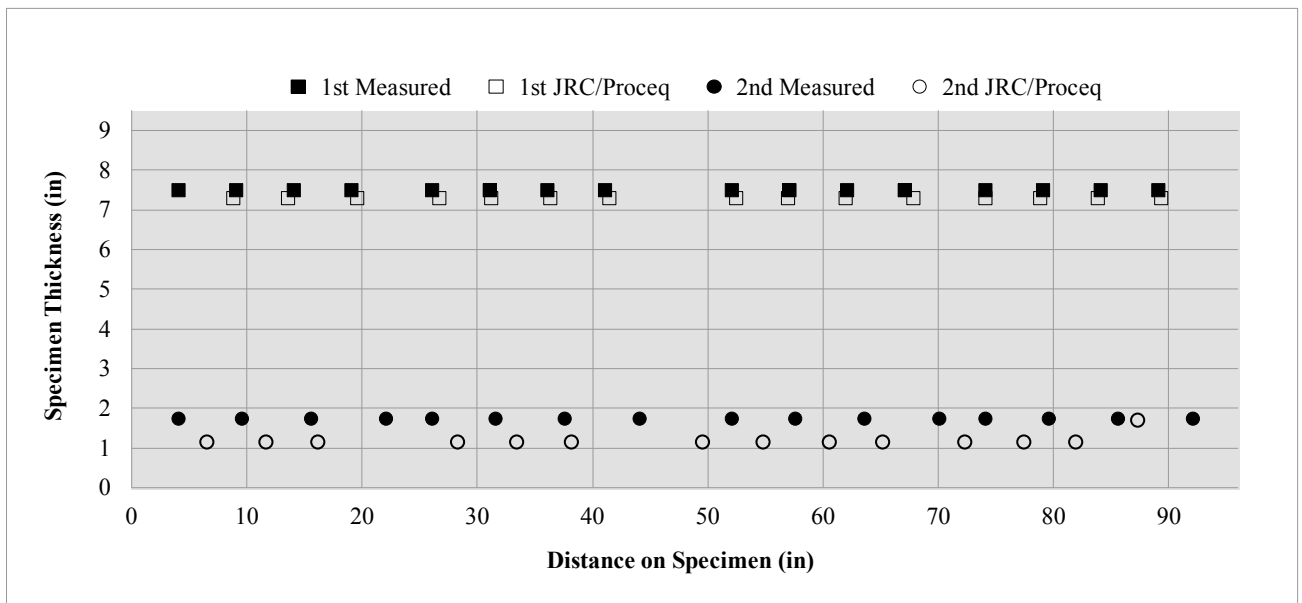

(a) Transverse Rebars

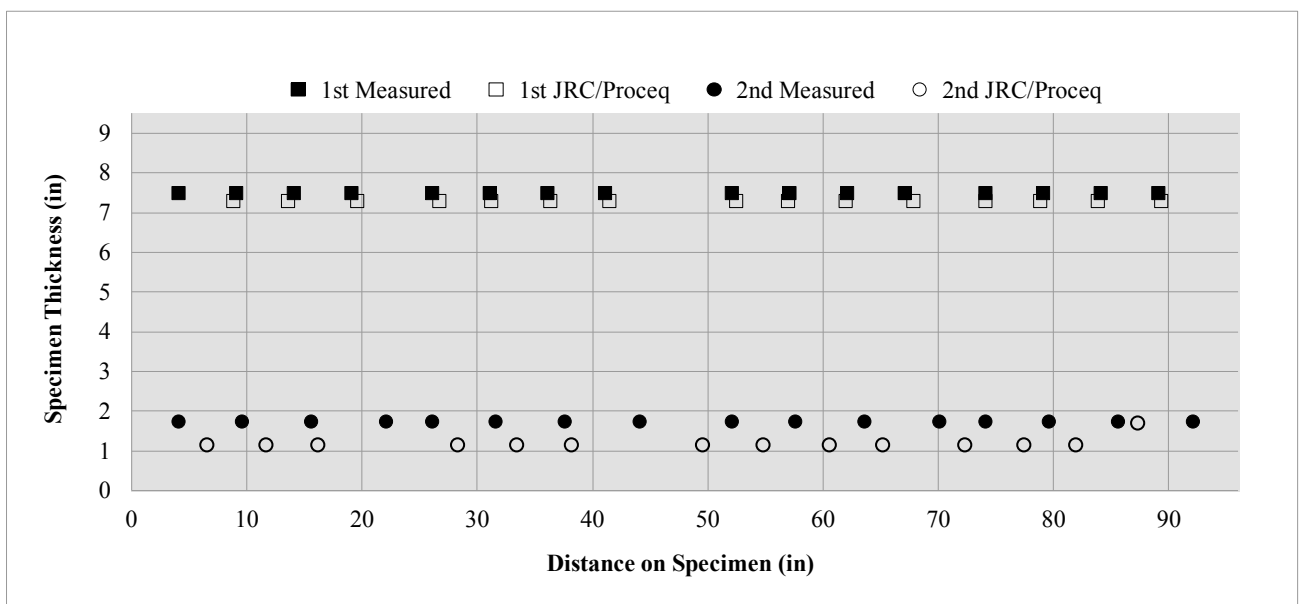

(b) Longitudinal Rebars

Figure 5.49. JRC/Proceq On-Site Results for 9.5-inch Thickness Reinforced Specimen (Small Rebars).

9.5-inches Thickness Reinforced Specimen (Big Rebars)

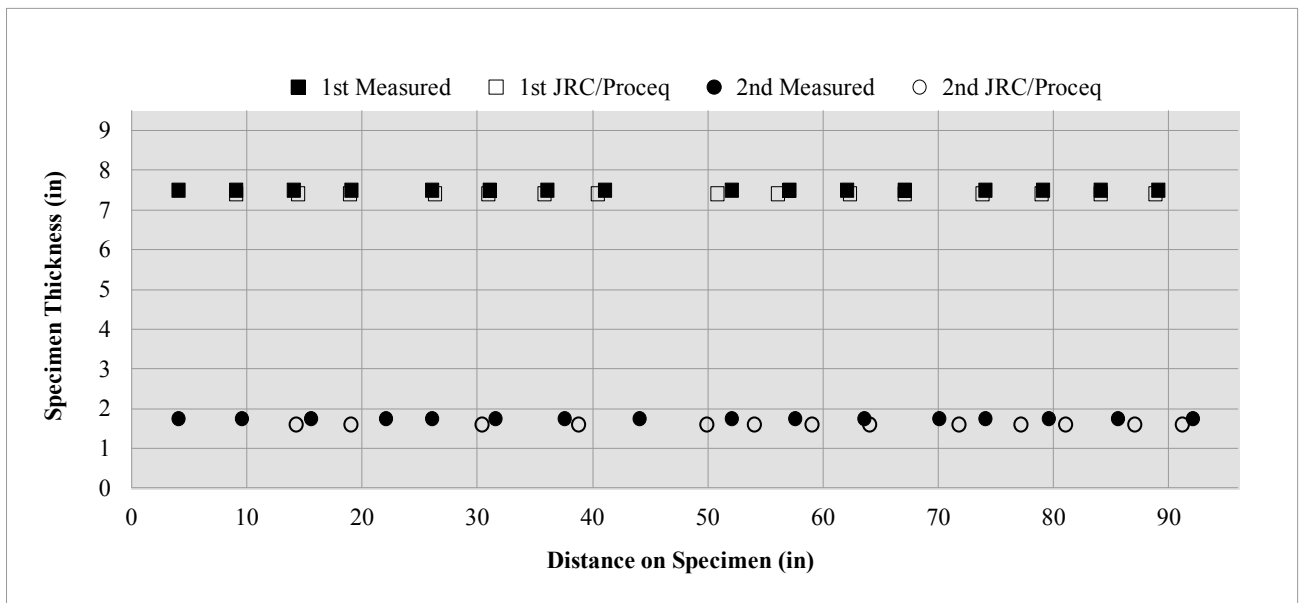

(a) Transverse Rebars

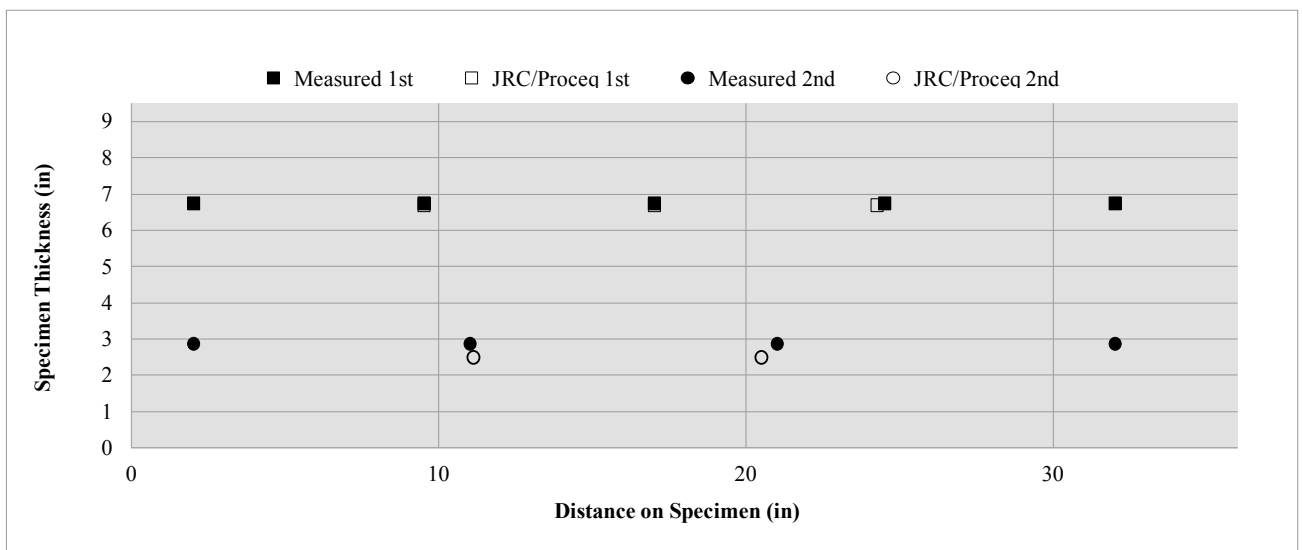

(b) Longitudinal Rebars

Figure 5.50. JRC/Proceq On-Site Results for 9.5-inch Thickness Reinforced Specimen (Big Rebars).

10-inches Thickness Reinforced Specimen

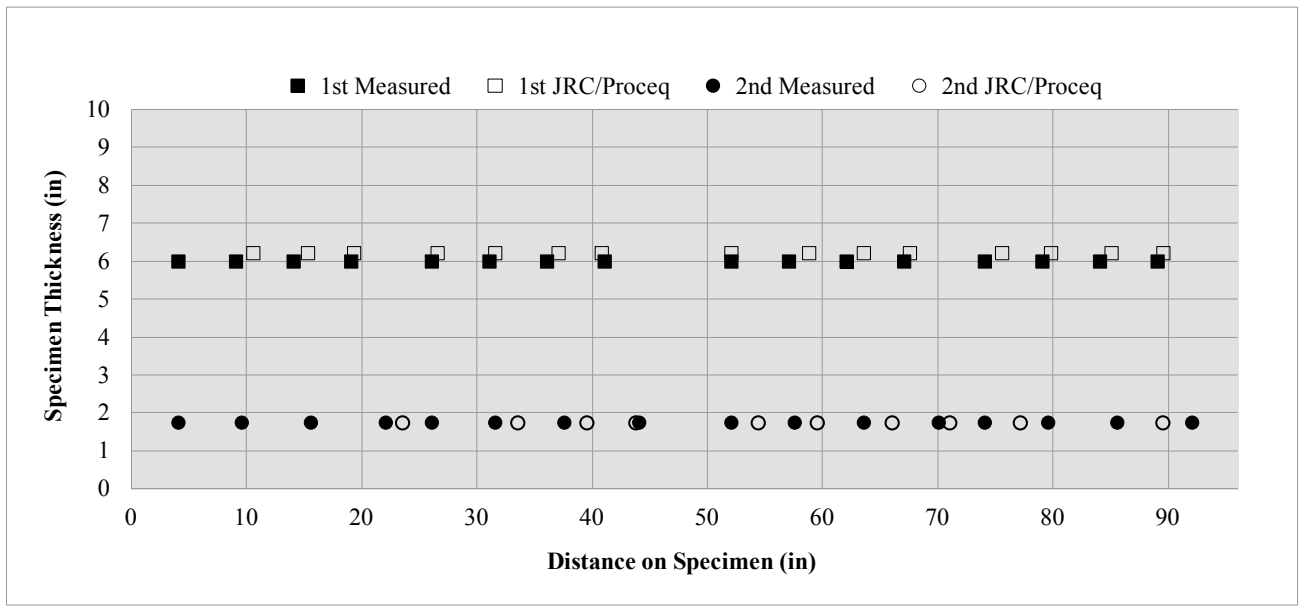

(a) Transverse Rebars

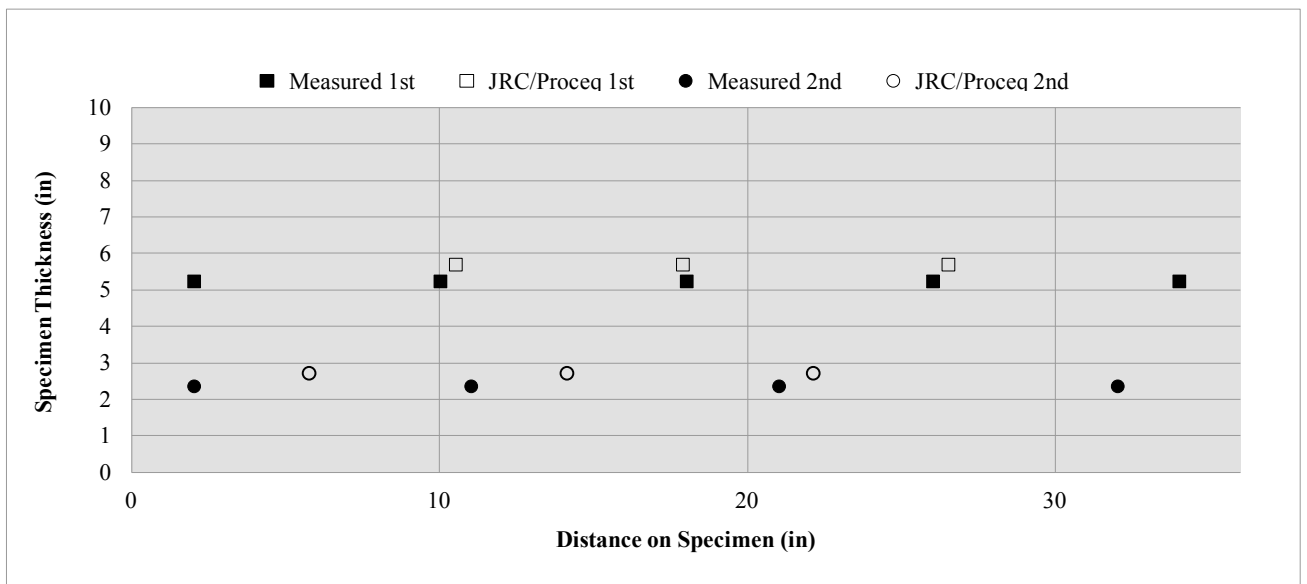

(b) Longitudinal Rebars

Figure 5.51. JRC/Proceq On-Site Results for 10-inch Thickness Reinforced Specimen.

10-inches Thickness Reinforced Specimen Elevated

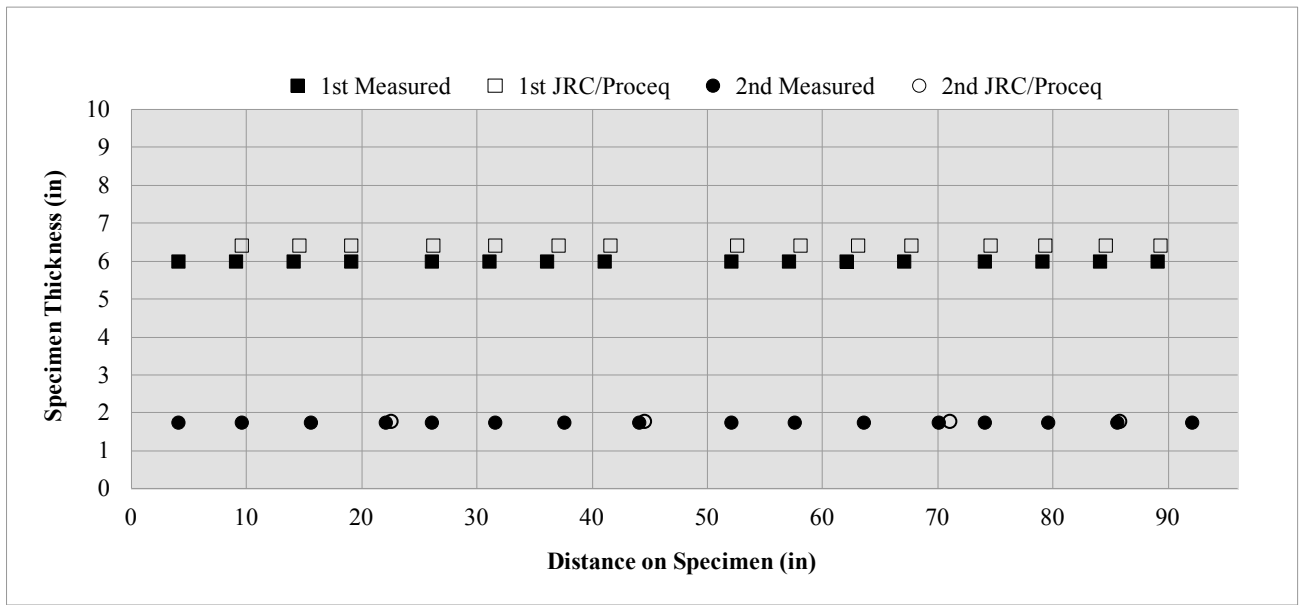

(a) Transverse Rebars

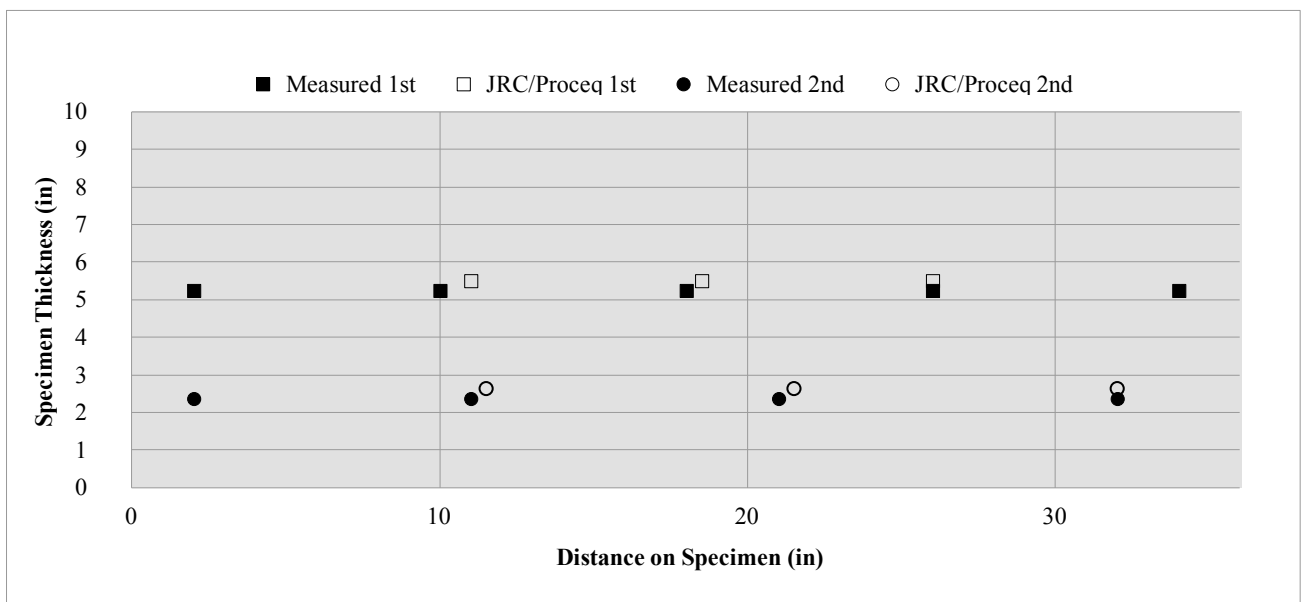

(b) Longitudinal Rebars

Figure 5.52. JRC/Proceq On-Site Results for 10-inch Thickness Reinforced Specimen Elevated.

Post-Processed JRC/Proceq Rebars Detection

Following the rebar analysis method utilized by Japan Radio Co., Ltd., is presented. Table 5.1 reports the steps followed to determine the correct rebar location.

Table 5.1. JRC Post-Processing Methodology to Determine the Correct Rebars Location.

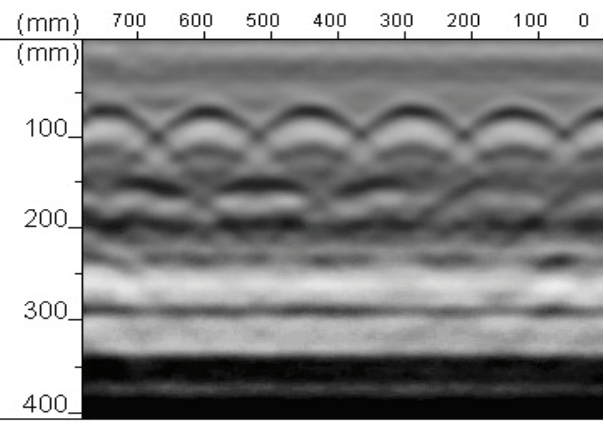
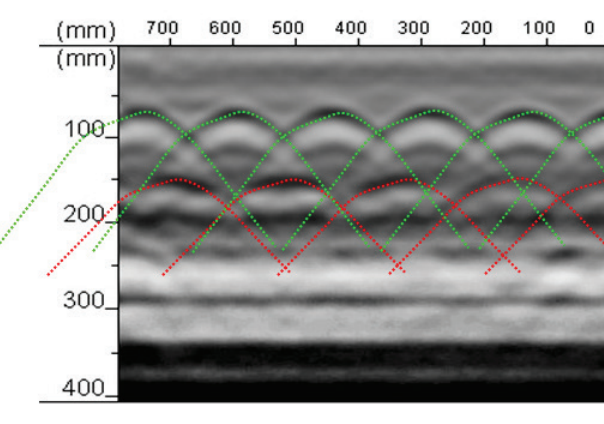
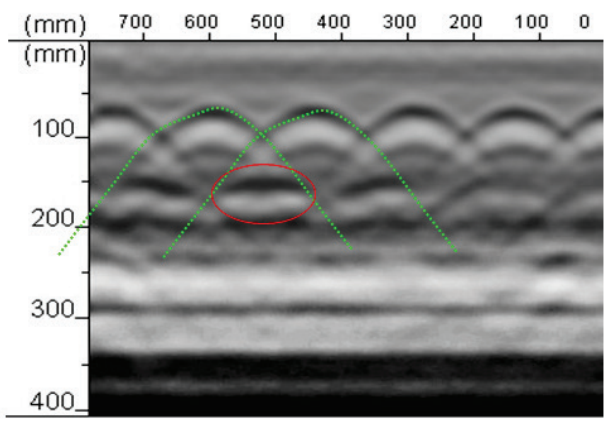
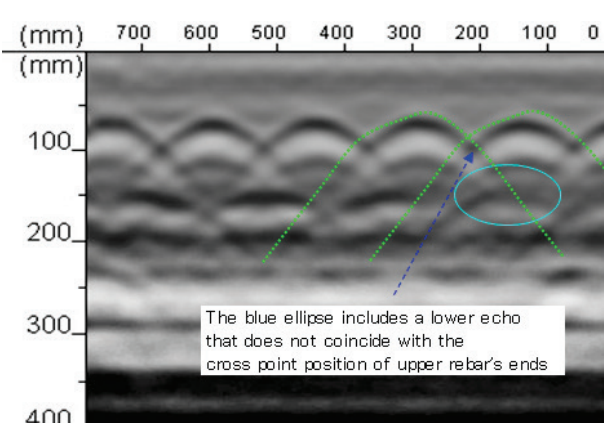
 <p>(mm) 700 600 500 400 300 200 100 0 (mm) 100 200 300 400 固定 比誘電率:8.0 感度:+2深 HS:105</p>	 <p>(mm) 700 600 500 400 300 200 100 0 (mm) 100 200 300 400</p>
<p>(a) Scanning Test Screen Example</p>	<p>(b) Drawn Shapes of Echo</p>
 <p>(mm) 700 600 500 400 300 200 100 0 (mm) 100 200 300 400</p>	 <p>(mm) 700 600 500 400 300 200 100 0 (mm) 100 200 300 400</p> <p>The blue ellipse includes a lower echo that does not coincide with the cross point position of upper rebar's ends</p>
<p>(c) Checking Cross Points of Echo's Ends - Case 1</p>	<p>(d) Checking Cross Points of Echo's Ends - Case 2</p>

The shapes of echo are first drawn on the scanned image (Table 5.1(b)). If the slopes of the upper and lower curves are similar, it could mean that the lower ones are multiple reflections of the upper ones (also known as ringing effect). If the lower red curves are less steep than the green ones,

the red curves should be angular images of existing rebars. Once the angular image of possible lower rebars are identified, it must be determined whether the echo is the cross point of the upper echo's ends or if it is, in fact, the echo of a lower rebar (Table 5.1(c) and (d)). As shown in Case 1 (Table 5.1(c)), it is difficult to determine whether the red ellipse includes the cross points of the upper echo's ends or if it identifies the echo of a lower rebar. As for Case 2 (Table 5.1(d)), the blue ellipse includes a lower echo that does not coincide with the cross point position of upper rebar's ends. Therefore, in this case the echo should identify the presence of a lower rebar.

Following, the post-processed data from each block with identification of upper and lower rebars is reported (Figures 5.53 to 5.66). Also, the rebars position determined after post processing the data collected with the GPR device from JRC/Proceq is illustrated for an effective comparison of the exact and estimated steel locations.

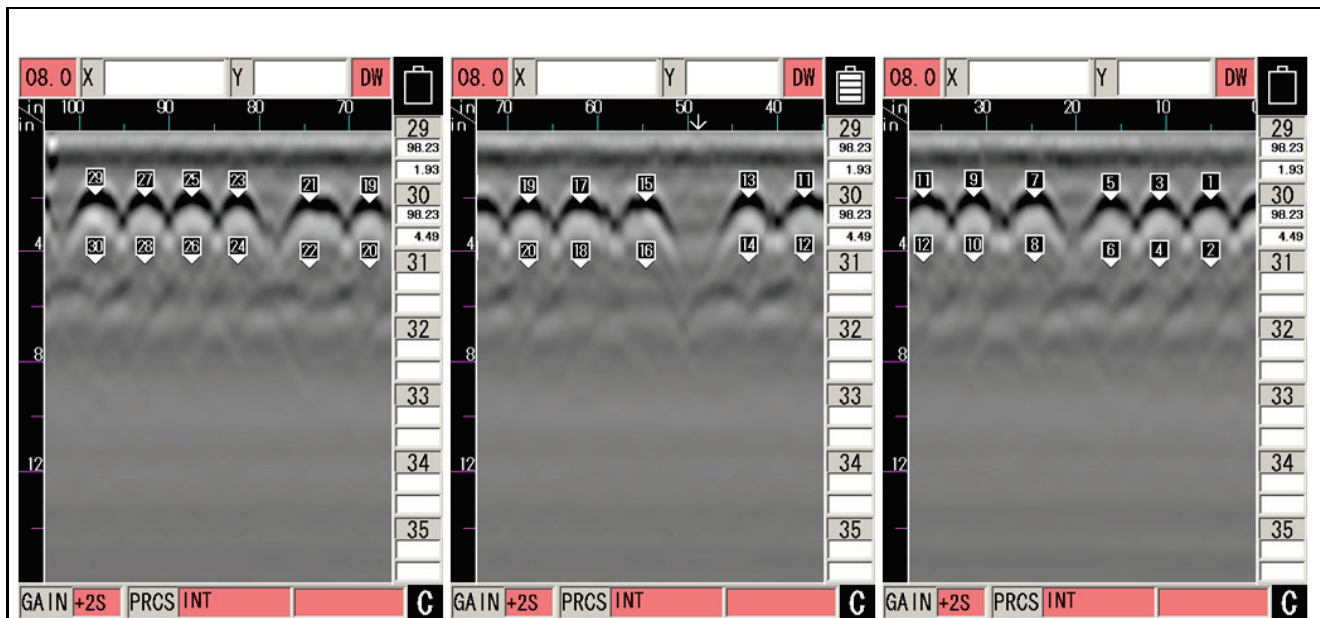

(a) Post-Processed Transverse Rebar Locations

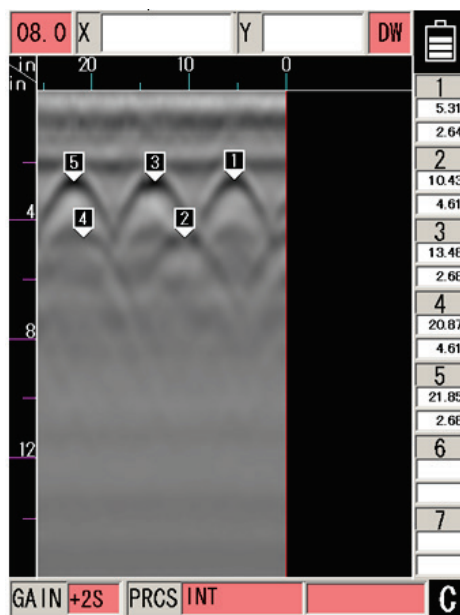

(b) Post-Processed Longitudinal Rebar Locations

Figure 5.53. JRC/Proceq Screenshots From Post-Processed Data of 7-inch Thick Block Results.

7-inches Thickness Reinforced Specimen

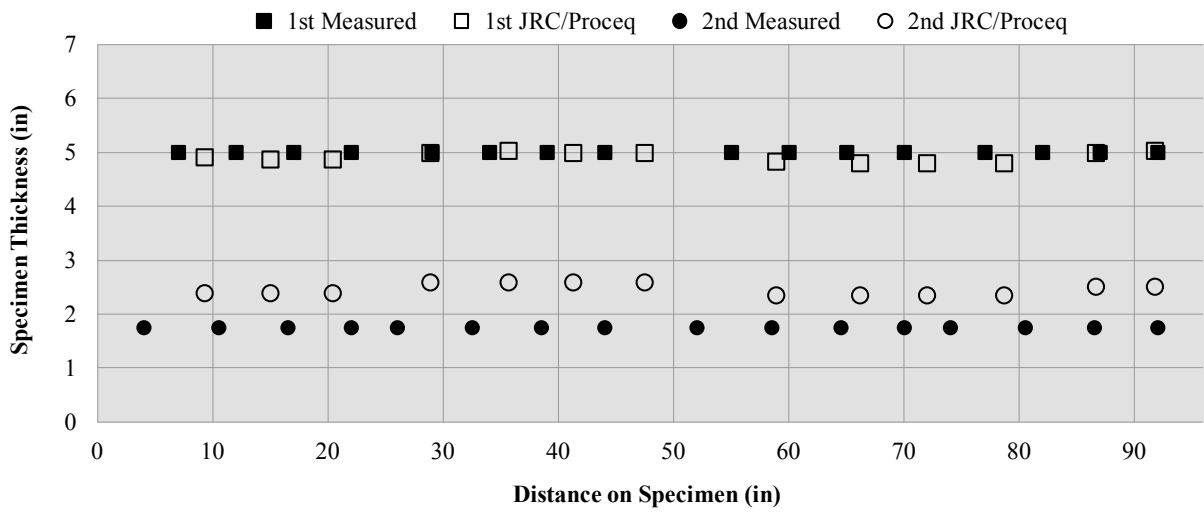

(a) Transverse Rebars

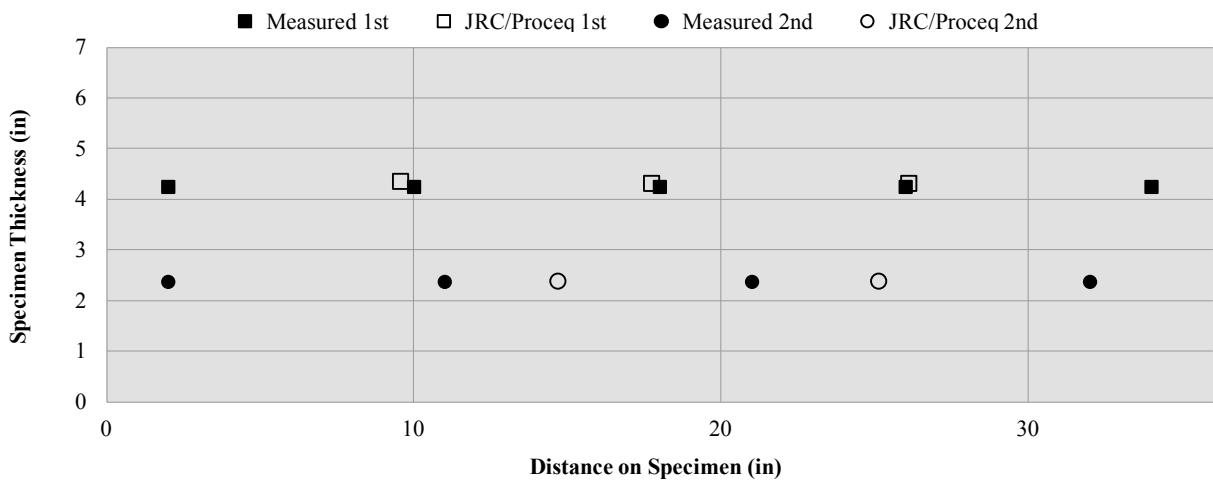

(b) Longitudinal Rebars

Figure 5.54. JRC/Proceq Post-processed Results for 7-inch Thickness Reinforced Specimen.

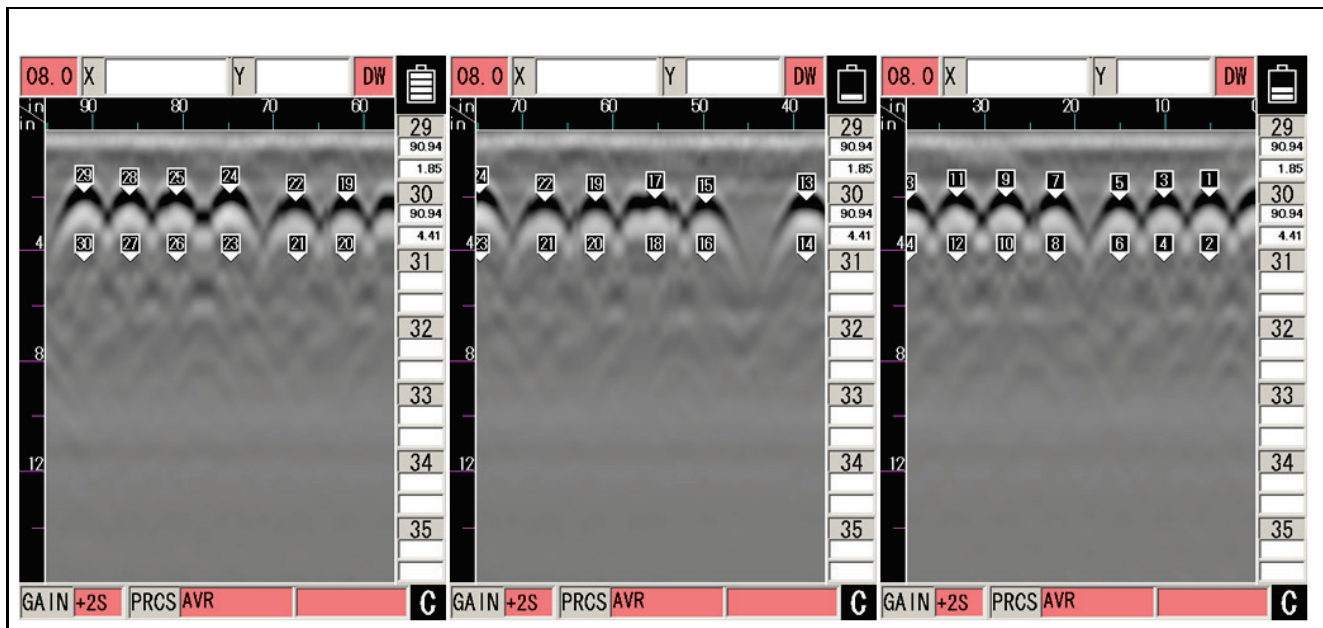

(a) Post-Processed Transverse Rebar Locations

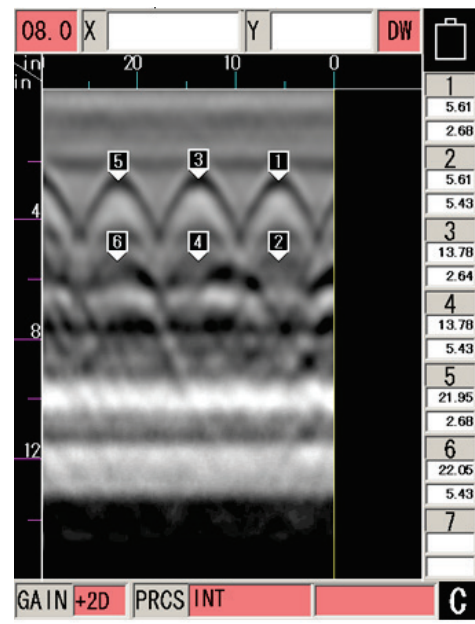

(b) Post-Processed Longitudinal Rebar Locations

Figure 5.55. JRC/Proceq Screenshots From Post-Processed Data of 8-inch Thick Block Results.

8-inches Thickness Reinforced Specimen

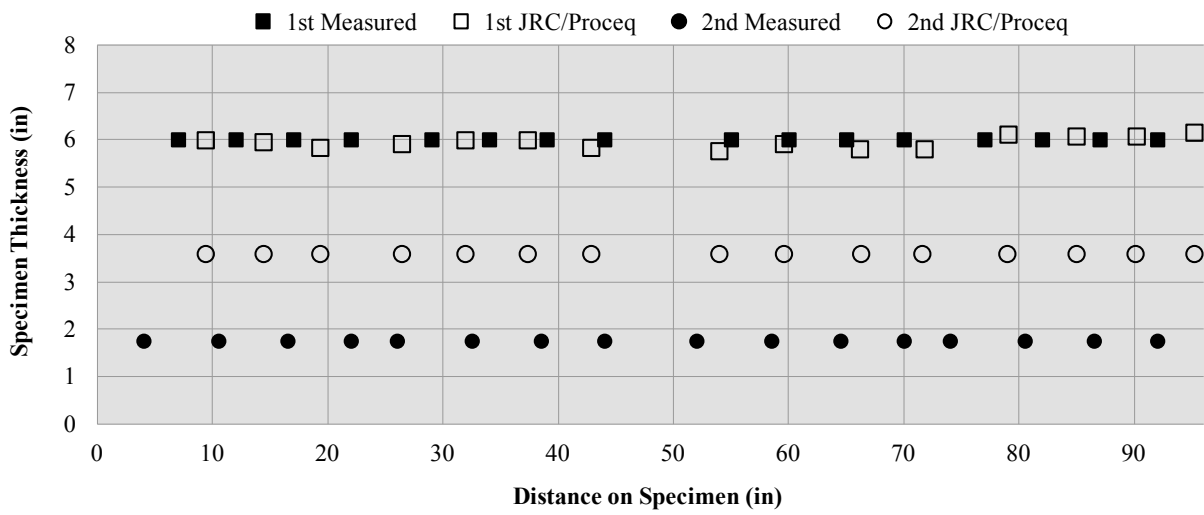

(a) Transverse Rebars

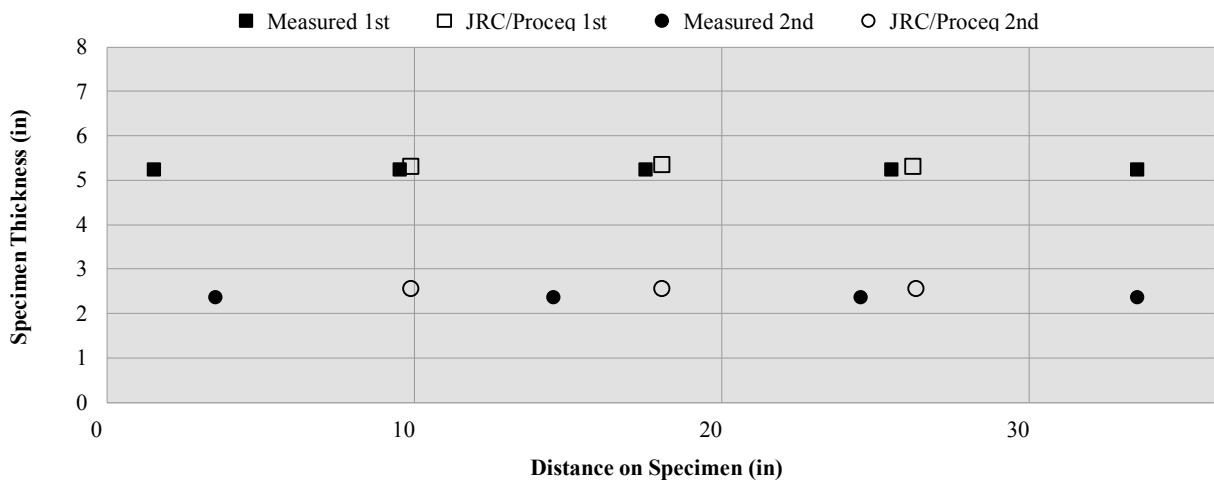

(b) Longitudinal Rebars

Figure 5.56. JRC/Proceq Post-processed Results for 8-inch Thickness Reinforced Specimen.

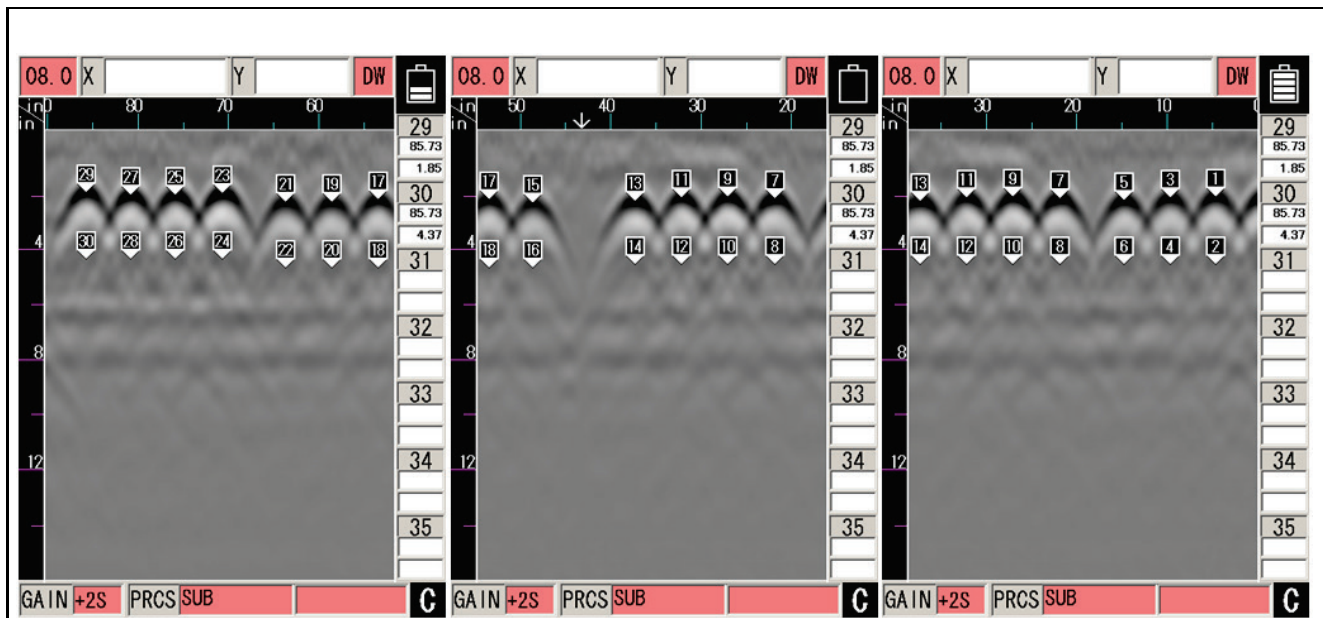

(a) Post-Processed Transverse Rebar Locations

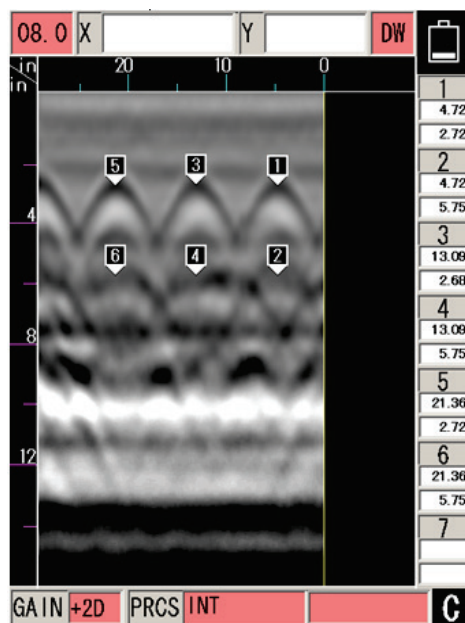

(b) Post-Processed Longitudinal Rebar Locations

Figure 5.57. JRC/Proceq Screenshots From Post-Processed Data of 8-inch Thick Elevated Block Results.

8-inches Thickness Reinforced Specimen Elevated

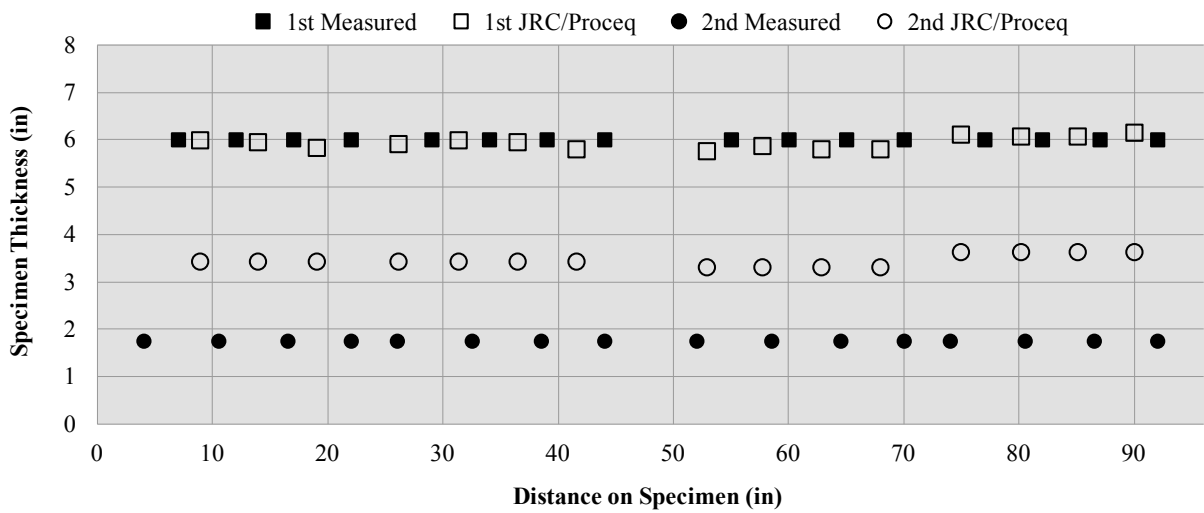

(a) Transverse Rebars

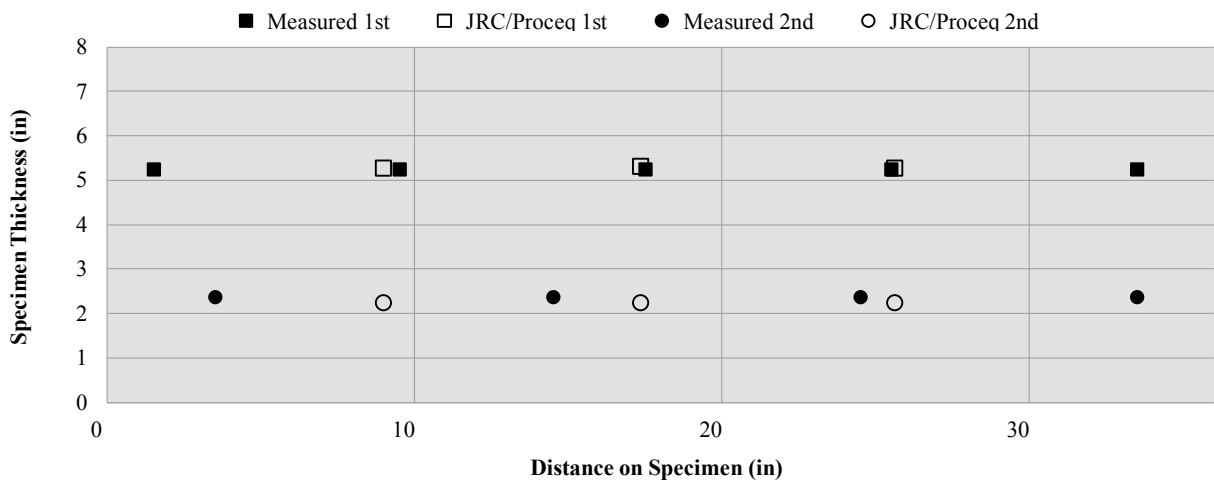

(b) Longitudinal Rebars

Figure 5.58. JRC/Proceq Post-processed Results for 8-inch Thickness Reinforced Specimen Elevated.

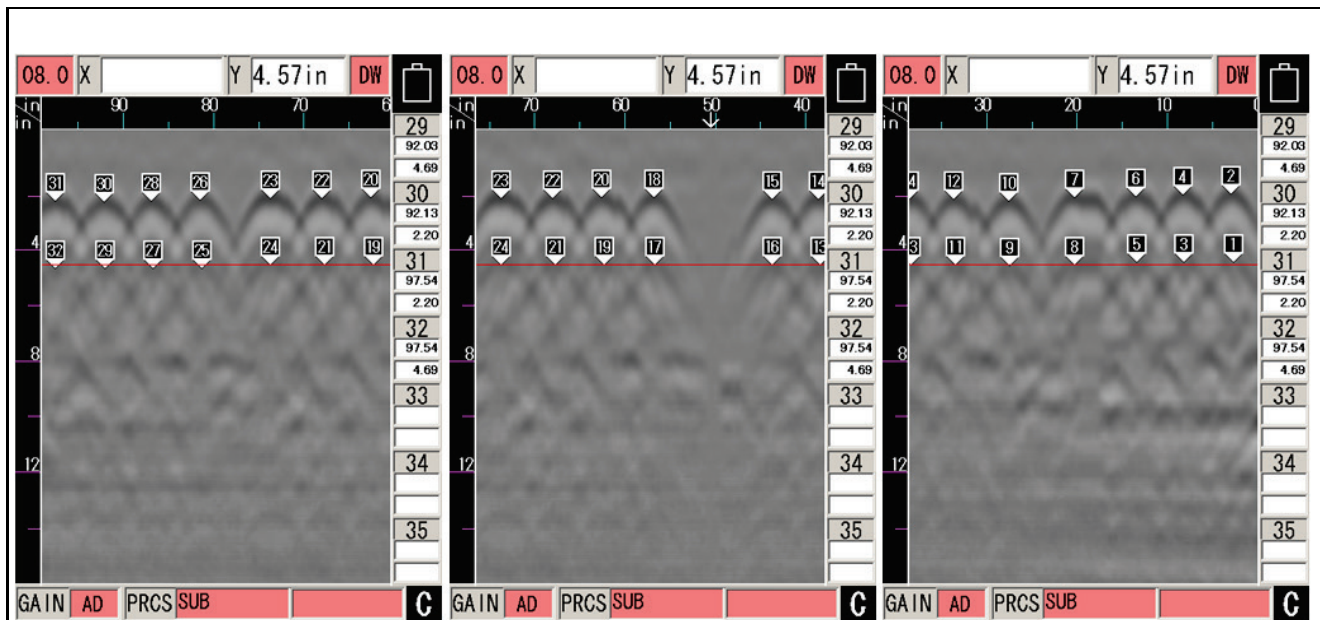

(a) Post-Processed Transverse Rebar Locations

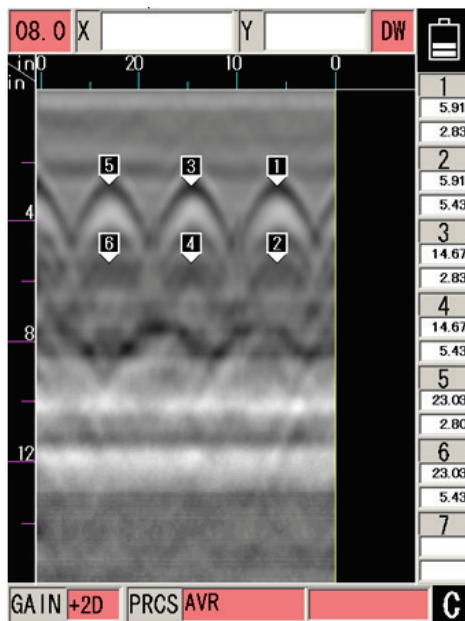

(b) Post-Processed Longitudinal Rebar Locations

Figure 5.59. JRC/Proceq Screenshots From Post-Processed Data of 9.5-inch Thick Block Results (Small Rebars).

9.5-inches Thickness Reinforced Specimen (Small Rebars)

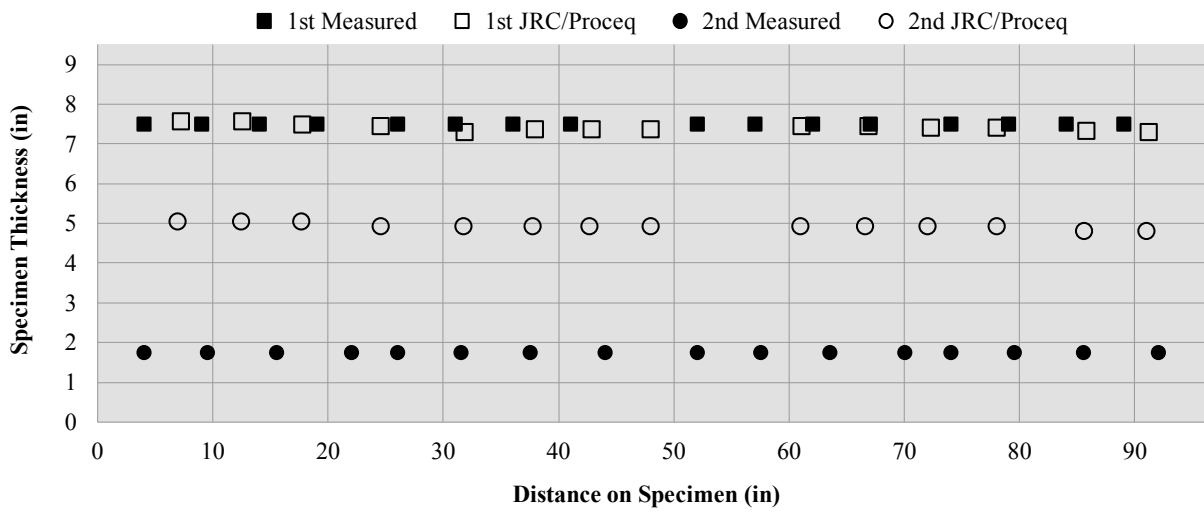

(a) Transverse Rebars

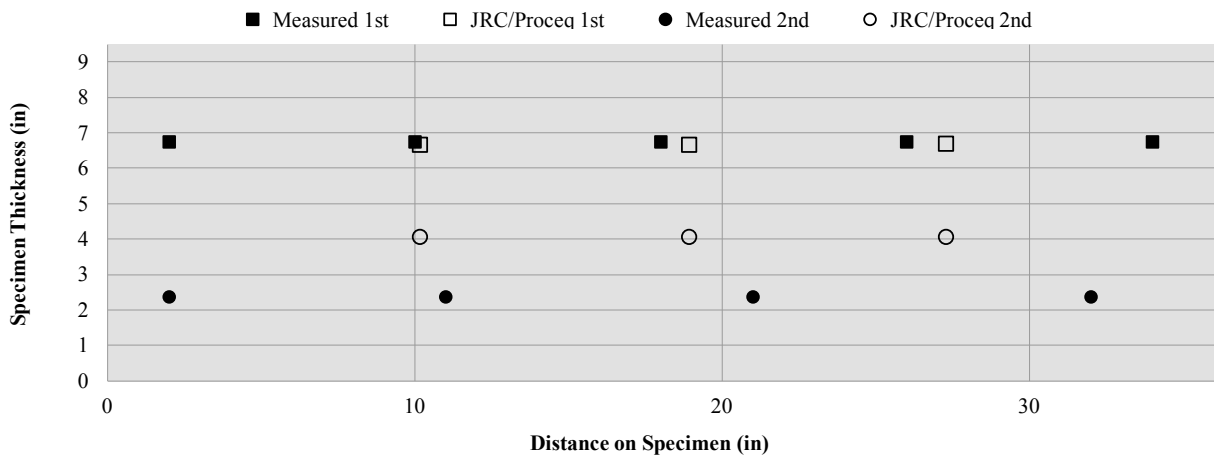

(b) Longitudinal Rebars

Figure 5.60. JRC/Proceq Post-processed Results for 9.5-inch Thickness Reinforced Specimen (Small Rebars).

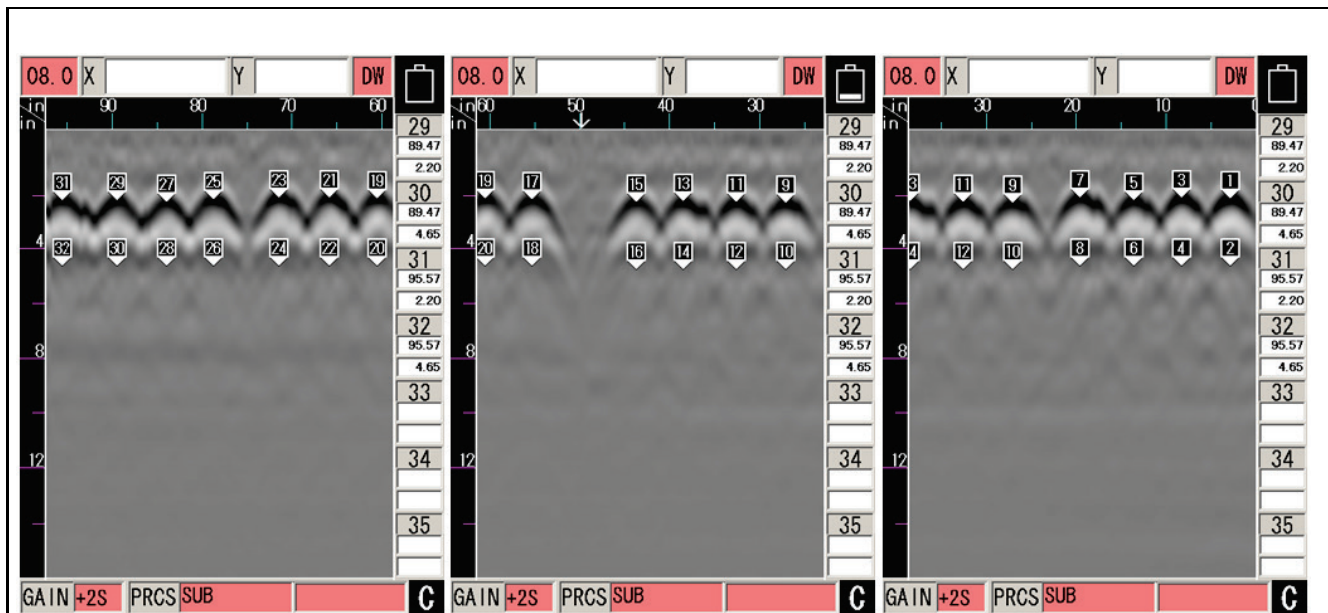

(a) Post-Processed Transverse Rebar Locations

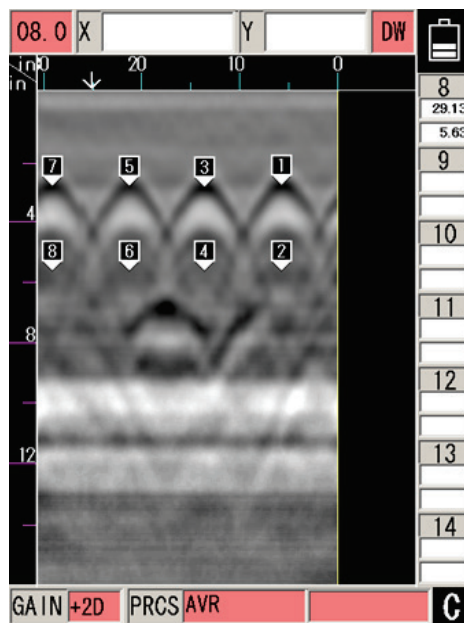

(b) Post-Processed Longitudinal Rebar Locations

Figure 5.61. JRC/Proceq Screenshots From Post-Processed Data of 9.5-inch Thick Block Results (Big Rebars).

9.5-inches Thickness Reinforced Specimen (Big Rebars)

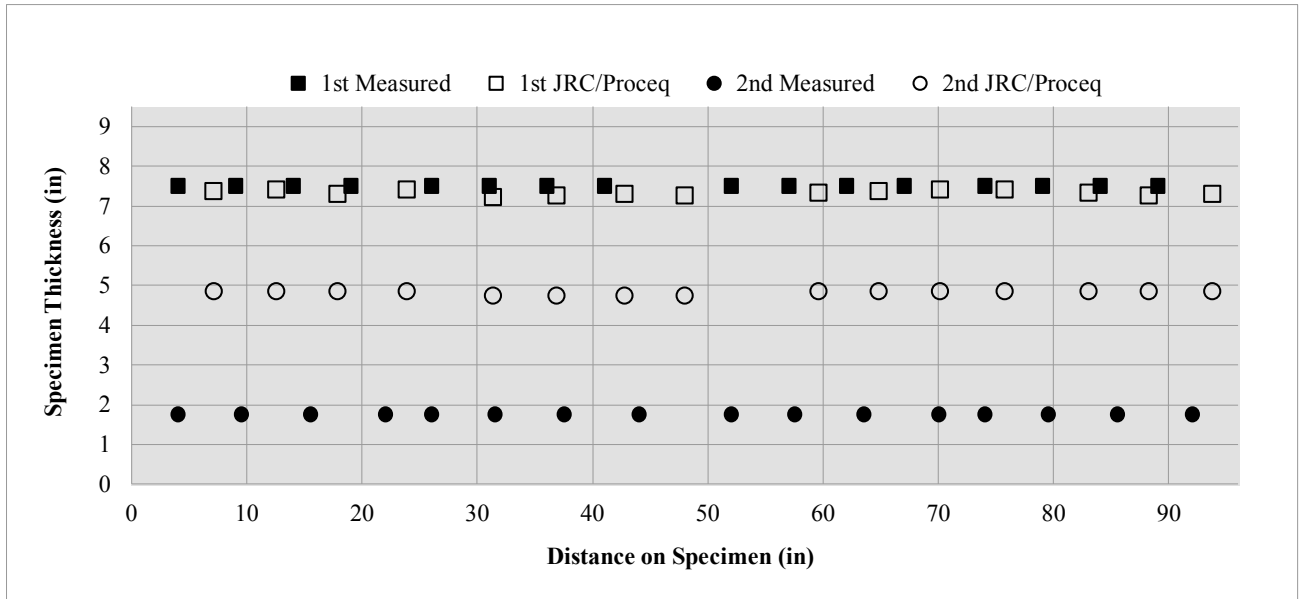

(a) Transverse Rebars

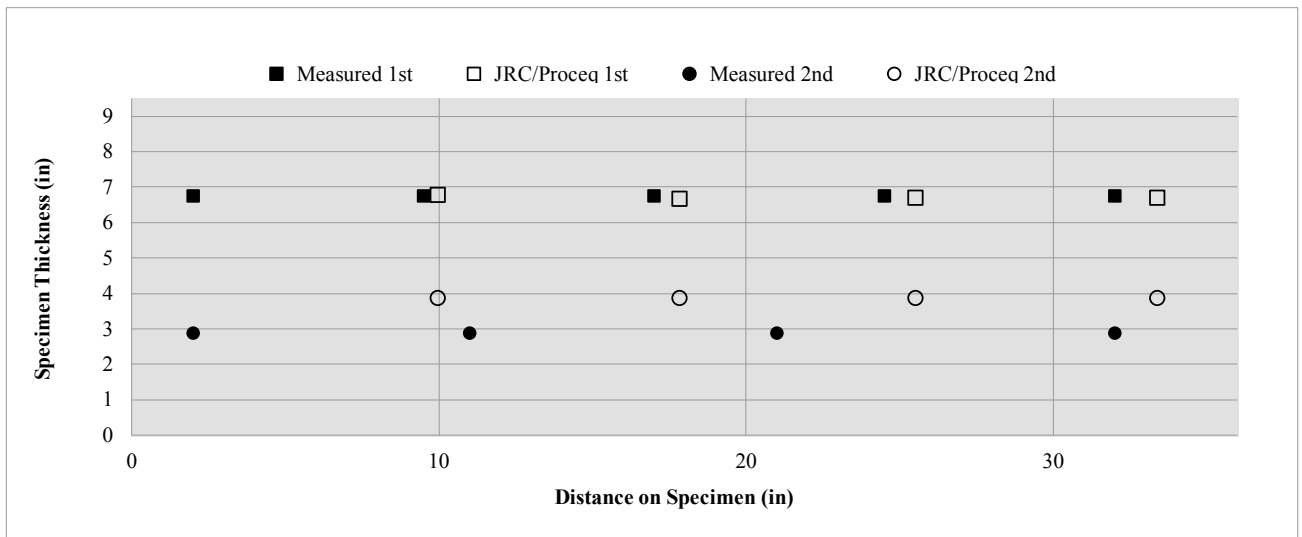

(b) Longitudinal Rebars

Figure 5.62. JRC/Proceq Post-processed Results for 9.5-inch Thickness Reinforced Specimen (Big Rebars).

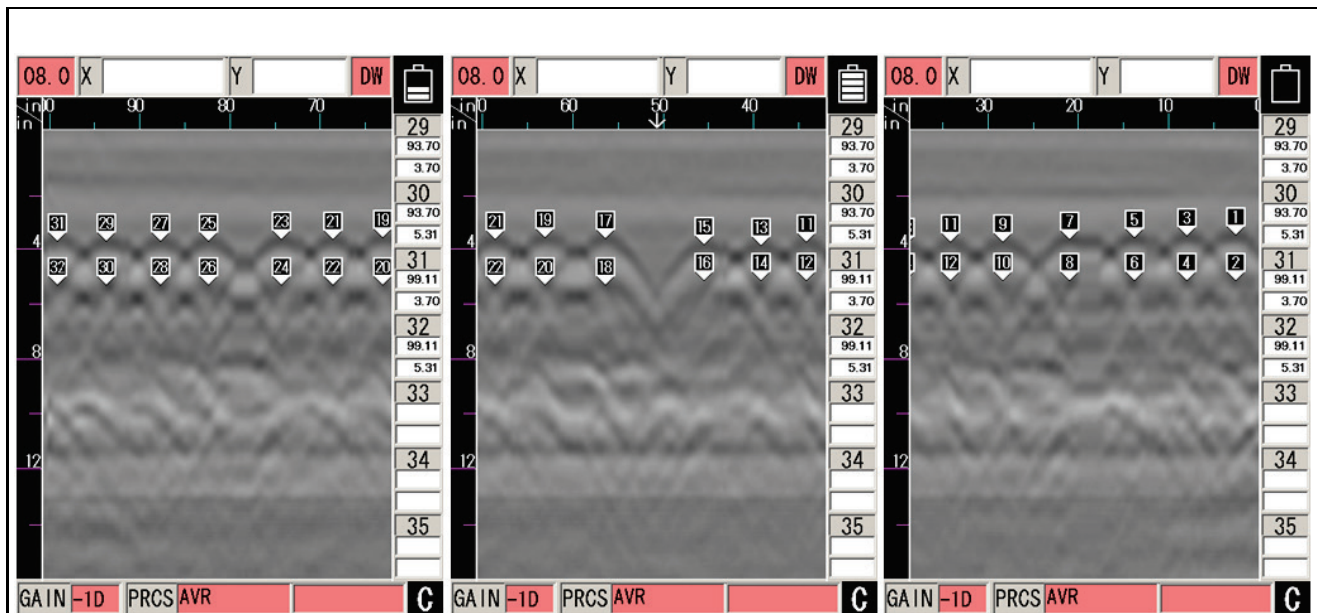

(a) Post-Processed Transverse Rebar Locations

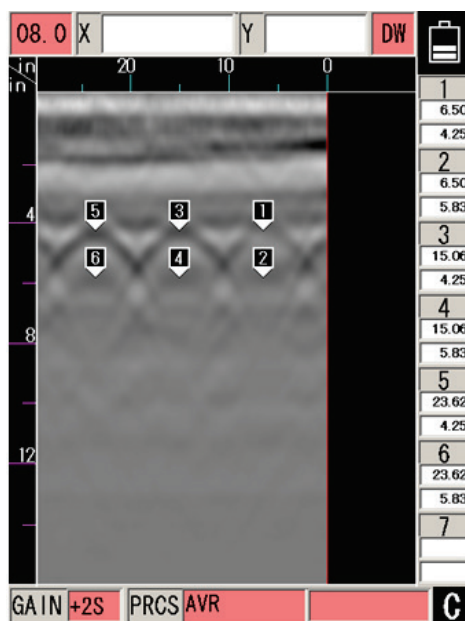

(b) Post-Processed Longitudinal Rebar Locations

Figure 5.63. JRC/Proceq Screenshots From Post-Processed Data of 10-inch Thick Block Results.

10-inches Thickness Reinforced Specimen

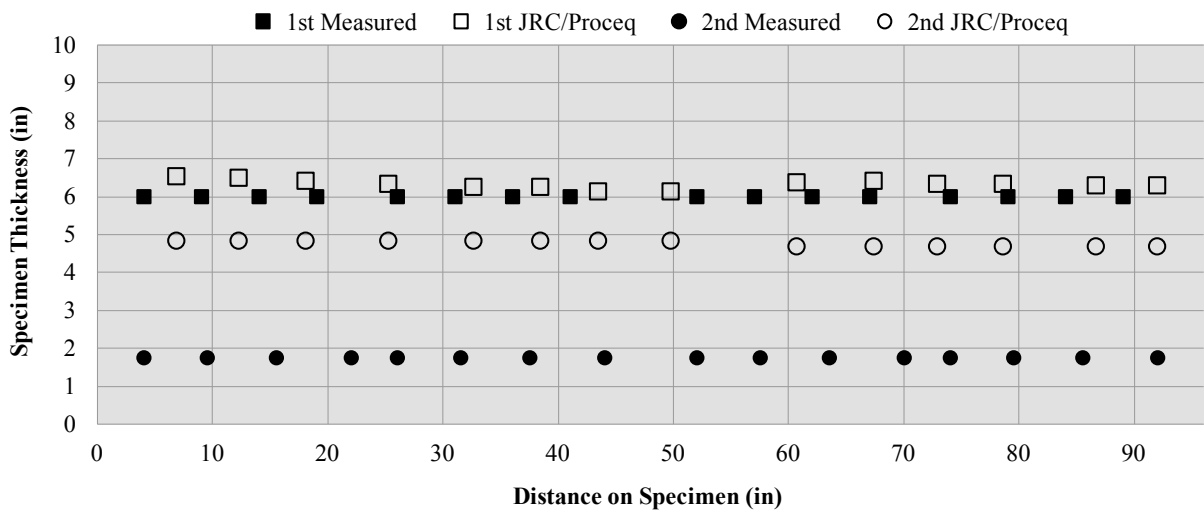

(a) Transverse Rebars

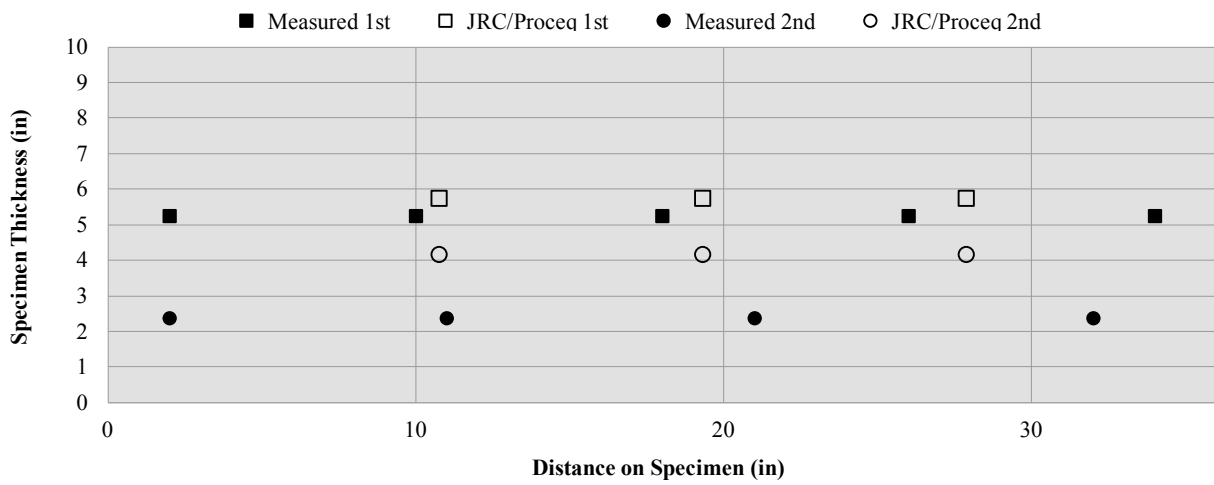

(b) Longitudinal Rebars

Figure 5.64. JRC/Proceq Post-processed Results for 10-inch Thickness Reinforced Specimen.

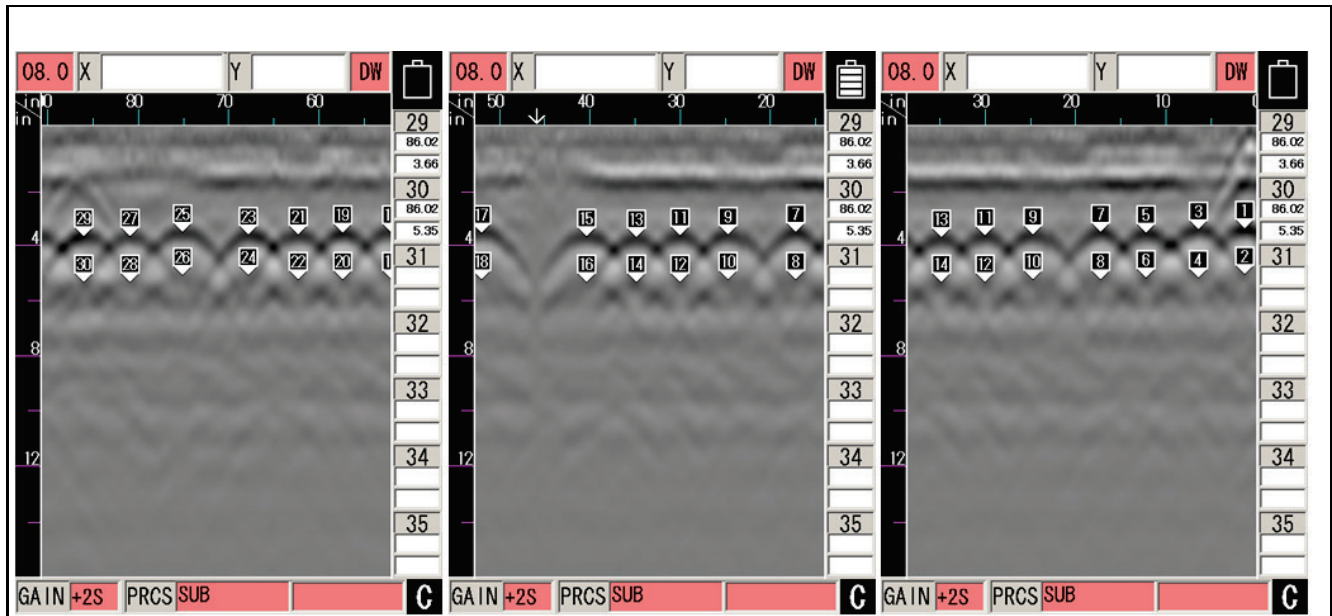

(a) Post-Processed Transverse Rebar Locations

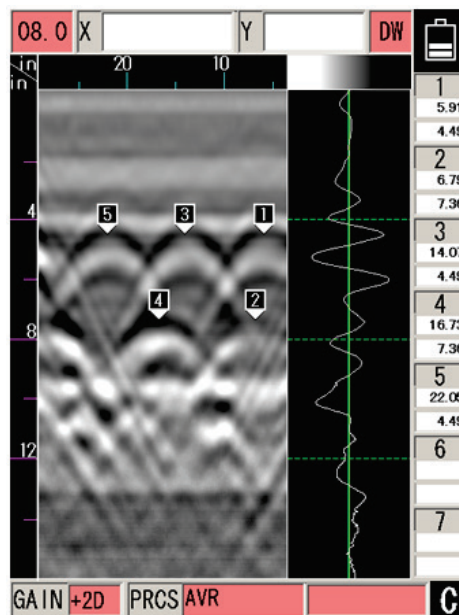

(b) Post-Processed Longitudinal Rebar Locations

Figure 5.65. JRC/Proceq Screenshots From Post-Processed Data of 10-inch Thick Elevated Block Results.

10-inches Thickness Reinforced Specimen Elevated

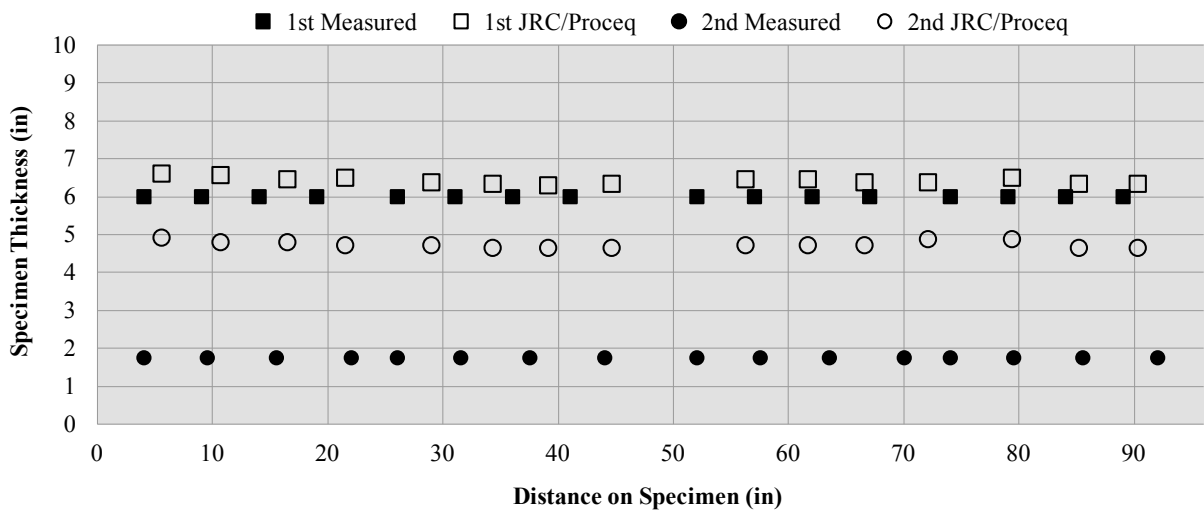

(a) Transverse Rebars

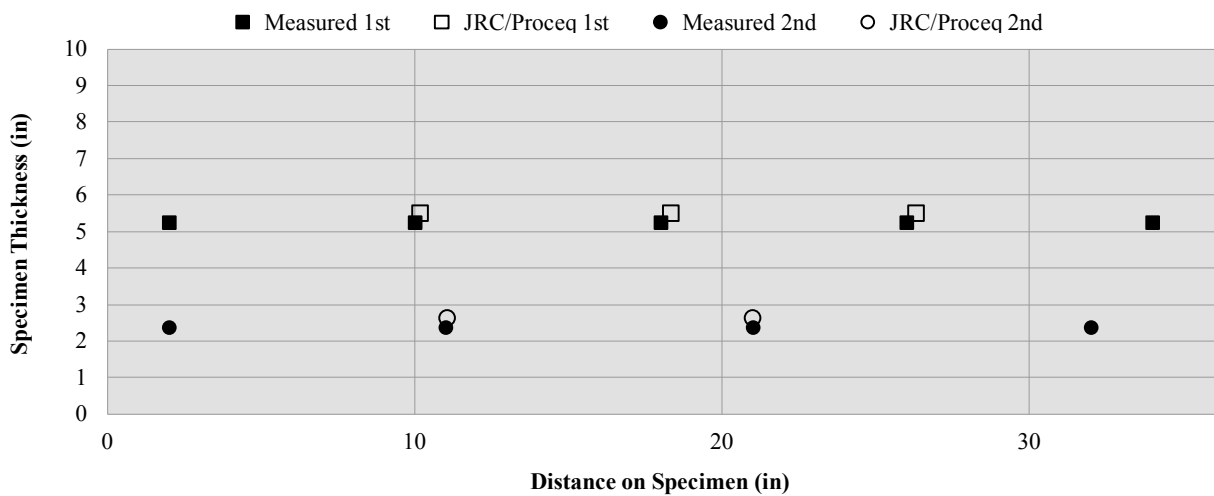

(b) Longitudinal Rebars

Figure 5.66. JRC/Proceq Post-processed Results for 10-inch Thickness Reinforced Specimen Elevated.

IDS/Olson Instruments Results

*On-Site Rebars IDS/Olson Instruments Detection**

All two-dimensional surveys were conducted using only five separate scans for the entirety of each slab during this investigation. All steel rebars are assumed straight. The final locations of steel are interpreted from the most accurate scan collected for each survey. The GPR method involves moving an antenna across a test surface while periodically pulsing both antenna and recording the received echoes in both the longitudinal and transversal directions, as diagrammed in Figure 5.67.

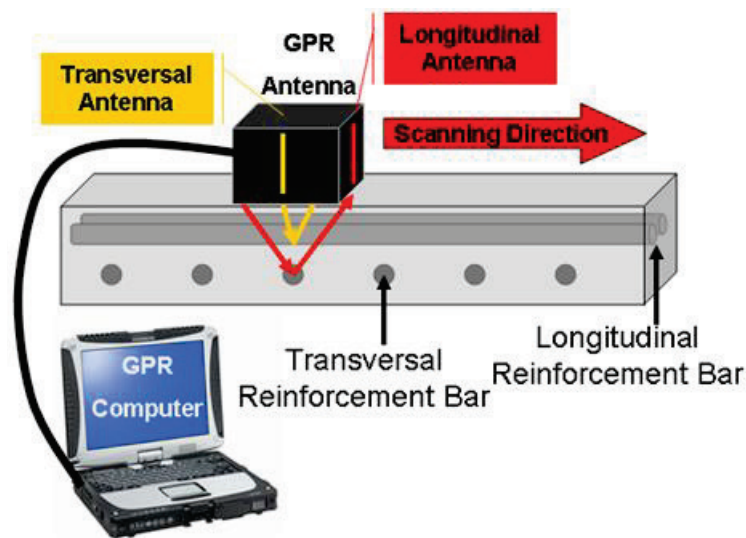

Figure 5.67. Typical Aladdin System Full-Polar GPR field setup.

Pulses are sent out from the GPR computer driving the antenna at a frequency range centered on the design center frequency of the antenna, in this case 2000 MegaHertz (MHz) equal to 2.0 GigaHertz (GHz). These electromagnetic wave pulses propagate through the material directly under the antenna, with some energy reflecting back whenever the wave encounters a change in electrical impedance, such as at a rebar or other steel embedment or air-filled void. The antenna then receives these echoes, which are amplified and filtered in the GPR computer, and then digitized and stored. A distance wheel records scan distance across the test surface and embedded features can be located as a given distance from the scan start position. For repetitive scanning, a standard survey is designed and adhered to as field conditions allow in order to minimize mistakes and maximize data quality. The scans for this investigation were created from pulses sent out at lateral intervals of approximately 45 scans per foot. The resulting raw data are in the form of echo amplitude versus time. By inputting the dielectric constant, which defines the material velocity, and by estimating the signal zero point, the echo time data can be converted to echo depth. The following equations explain this conversion:

* SOURCE: Olson Instruments

$$V_{EM} = c / \epsilon_r^{0.5} \quad (1)$$

$$D = (V_{EM} * T) / 2 \quad (2)$$

where:

V_{EM} = material electromagnetic velocity;

c = speed of light (in air);

ϵ_r = material relative dielectric constant;

D = depth; and

T = two-way radar pulse travel time.

If more accurate depth data are required, a depth calibration can be done if an embedment of a known depth is available to scan over (or the backside reflection of the wall). The scans are then typically plotted as two-dimensional (2D) waterfall plots of all of the individual data traces collected, with the lightness or darkness (or color) of each point in the plot being set by the amplitude and polarity (positive or negative) of the data at a given depth in each trace. Further 3-D interpolation can be performed to generate a cubic display of data by combining both the longitudinal and transversal data that are collected along a single longitudinal scan (due to the full-polar mechanics of the antenna). This data cube can then be sliced along certain planes (typically XY, XZ, and YZ) to enhance recognition and display of target features. Also, amplitude threshold constraints can be set to allow display of GPR reflections within the given threshold values. Regional features are often more easily recognized when viewing a slice of 3-D interpolated data. With tight scan spacing and the ability to measure both the longitudinal and transversal directions at the same time however, it is very possible to develop high resolution three-dimensional (3D) imaging for locating specific features that are not regional to a specific survey.

The Aladdin Full-Polar bow-tie antenna configuration consists of:

the front and back pair of antennas (H-H', 10001),

the left and right pair of antennas (V-V', 20001),

the front to right (H-V', 30001), and

left to rear (V-H', 40001).

The four orientations provide for increased resolution of transversal, longitudinal and angled rebars when all four antenna 2 GigaHertz combinations are recorded. The Full-Polar antenna layout is shown in Figure 5.68.

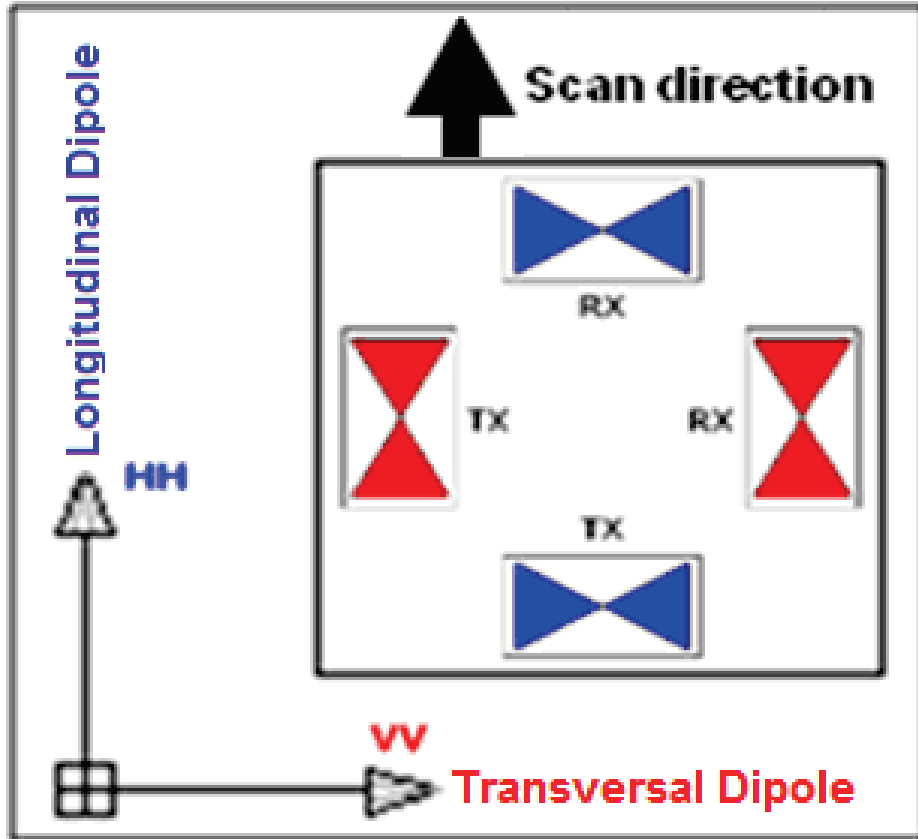
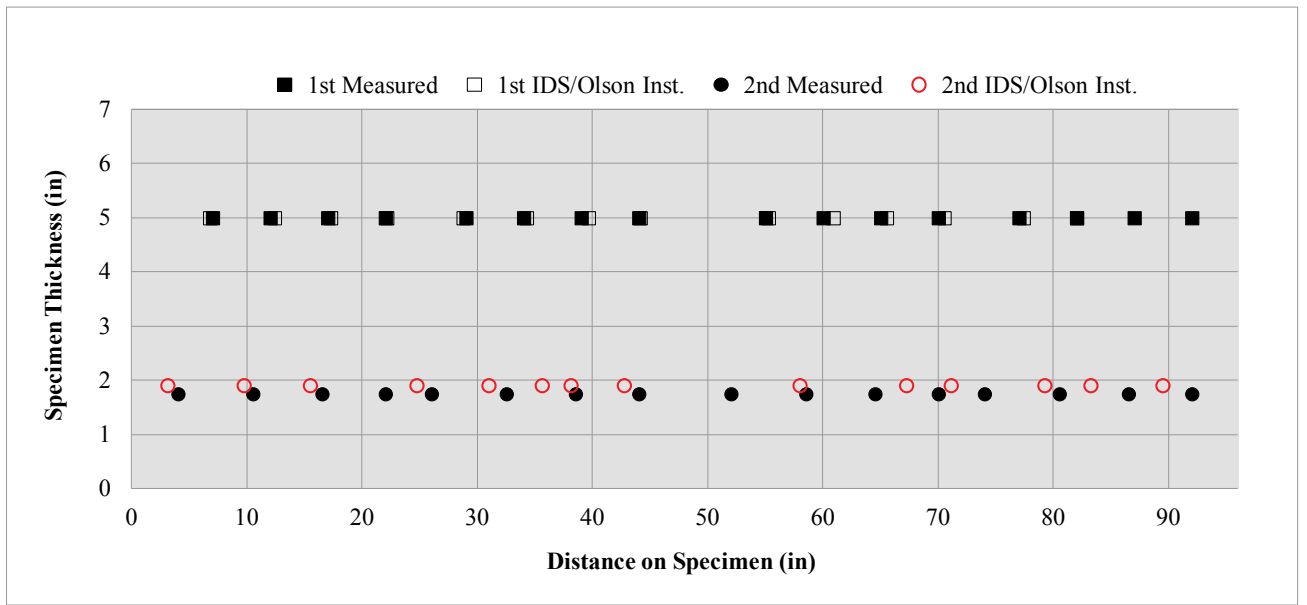

Figure 5.68. Full-Polar Antenna Layout of the Aladdin GPR system.

More details on the characteristics and use of the IDS/Olson Instruments device are reported in Appendix J.

Figures 5.69 to 5.74 show the results obtained from the reinforced concrete specimens scanning with the Aladdin System from IDS/Olson Instruments. Each figure reports the measured exact position of the steel reinforcement from the first and second layer in each slab. Also, the rebars positions determined by the GPR device from IDS/Olson Instruments on site measurements are illustrated for an effective comparison of the exact and estimated steel locations.

7-inches Thickness Reinforced Specimen



(a) Transverse Rebars

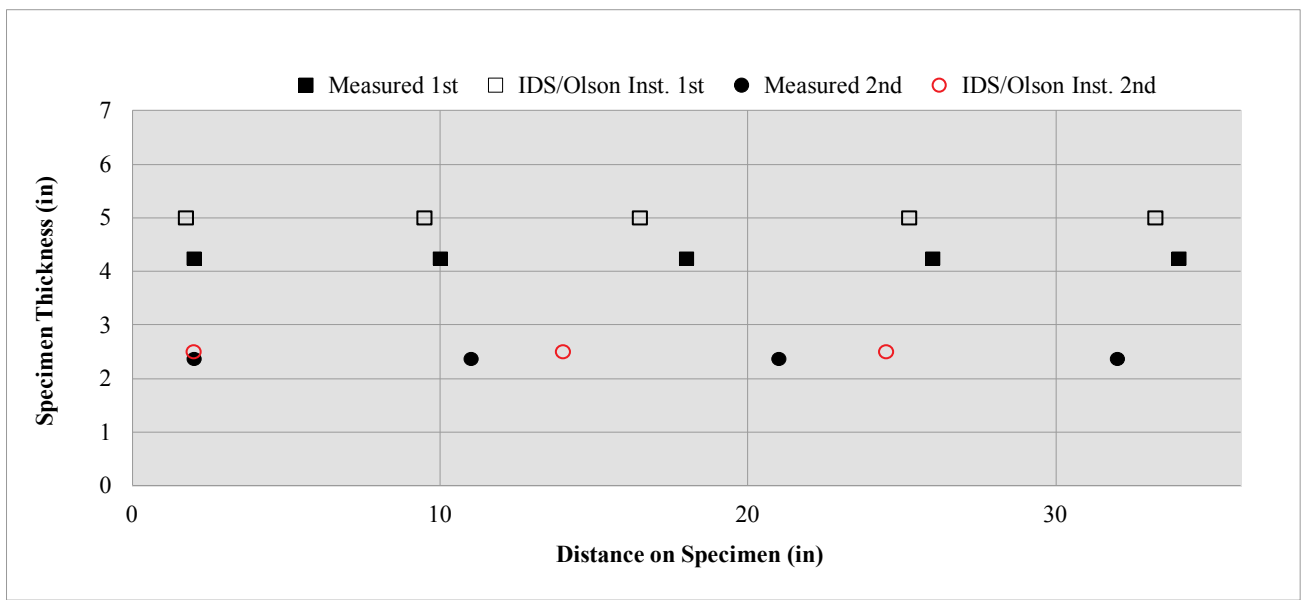

(b) Longitudinal Rebars

*Red measurements are referred to rebar positions for which it was not reported concrete coverage.

Figure 5.69. IDS/Olson Instruments On-Site Results for 7-inch Thickness Reinforced Specimen.

8-inches Thickness Reinforced Specimen

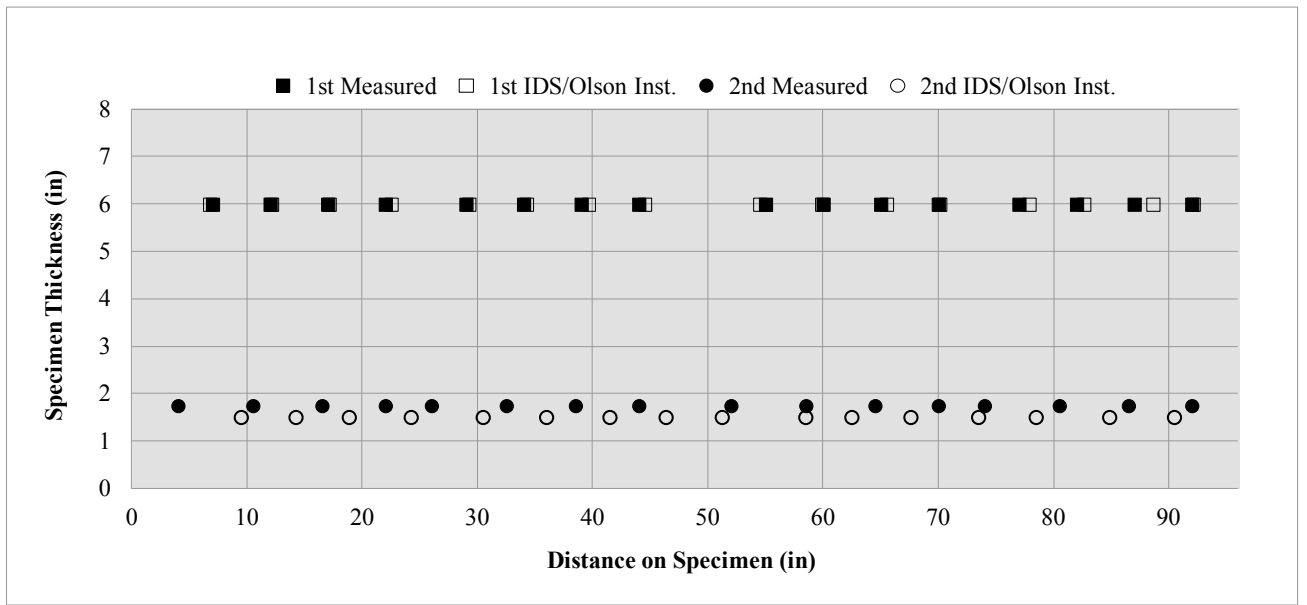

(a) Transverse Rebars

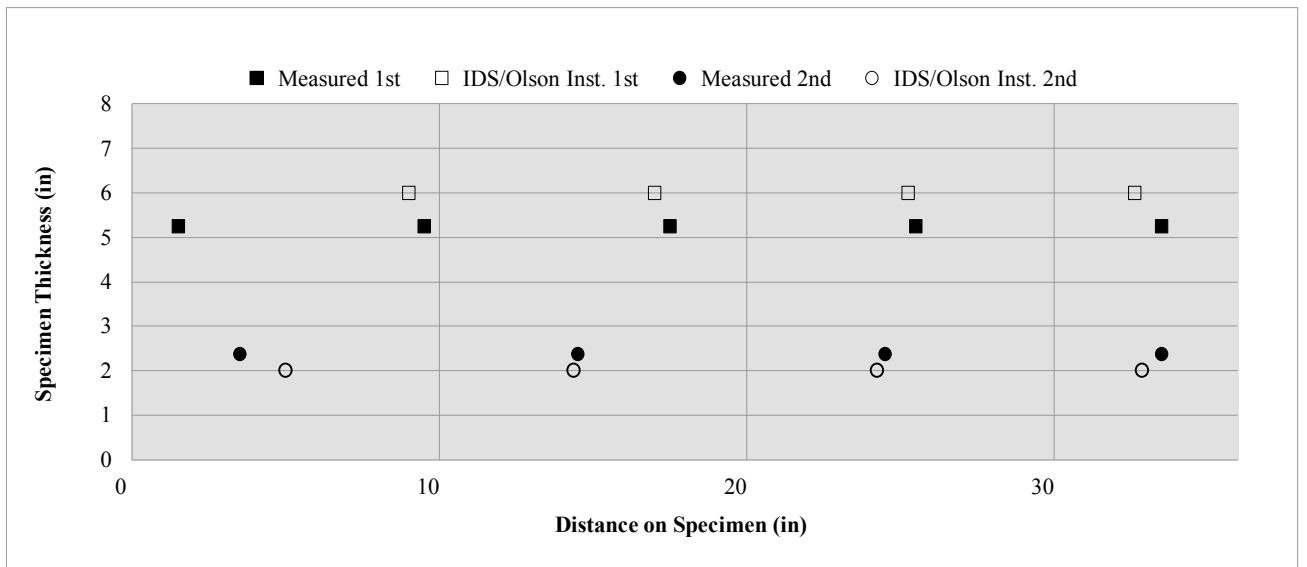

(b) Longitudinal Rebars

Figure 5.70. IDS/Olson Instruments On-Site Results for 8-inch Thickness Reinforced Specimen.

9.5-inches Thickness Reinforced Specimen (Small Rebars)

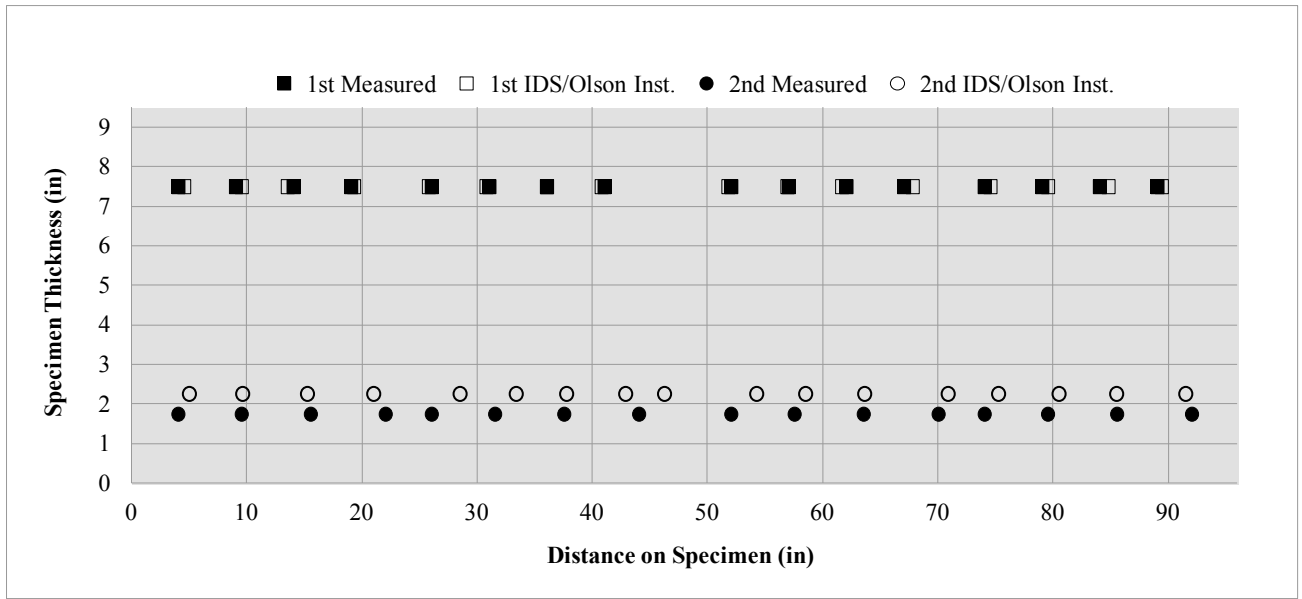

(a) Transverse Rebars

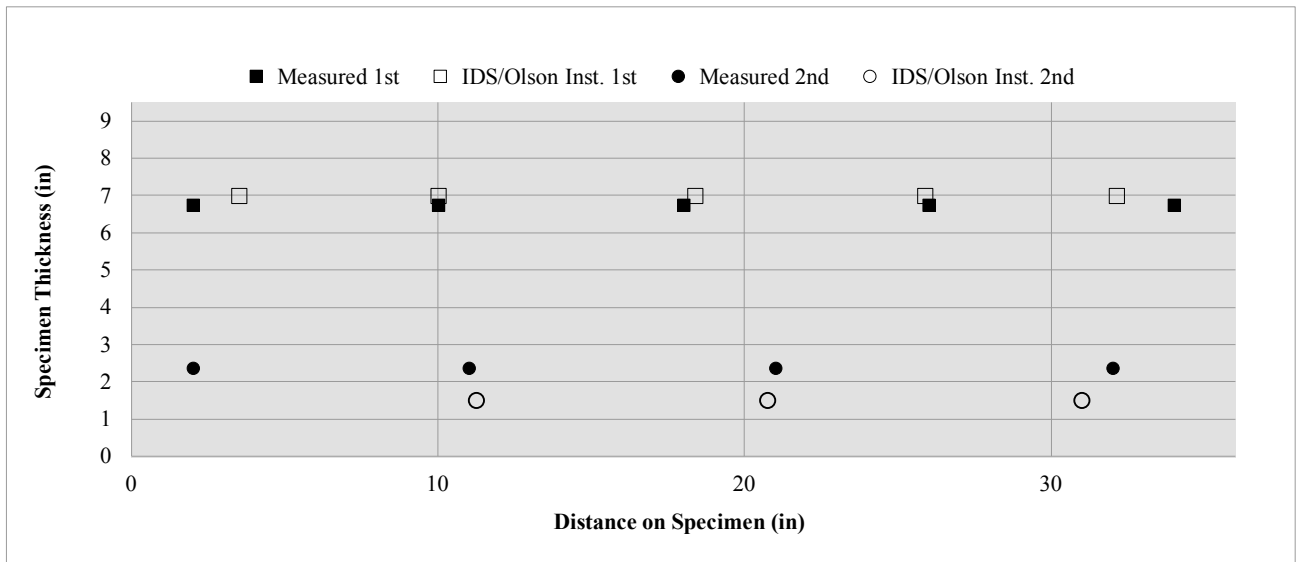

(b) Longitudinal Rebars

Figure 5.71. IDS/Olson Instruments On-Site Results for 9.5-inch Thickness Reinforced Specimen (Small Rebars).

9.5-inches Thickness Reinforced Specimen (Big Rebars)

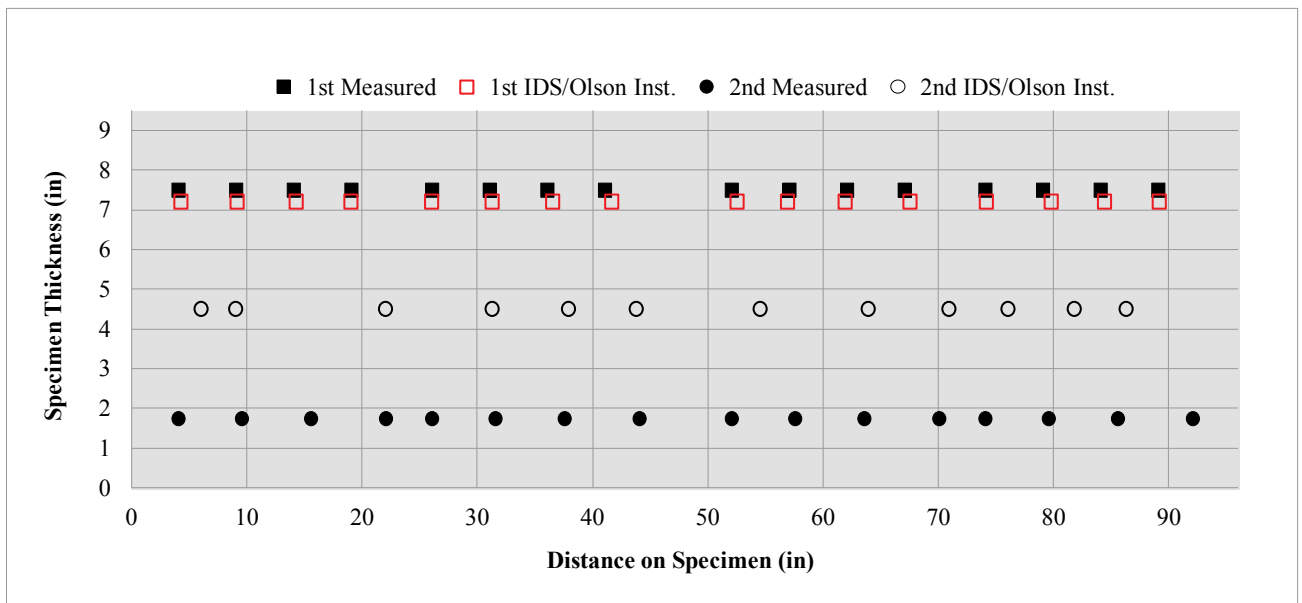

(a) Transverse Rebars

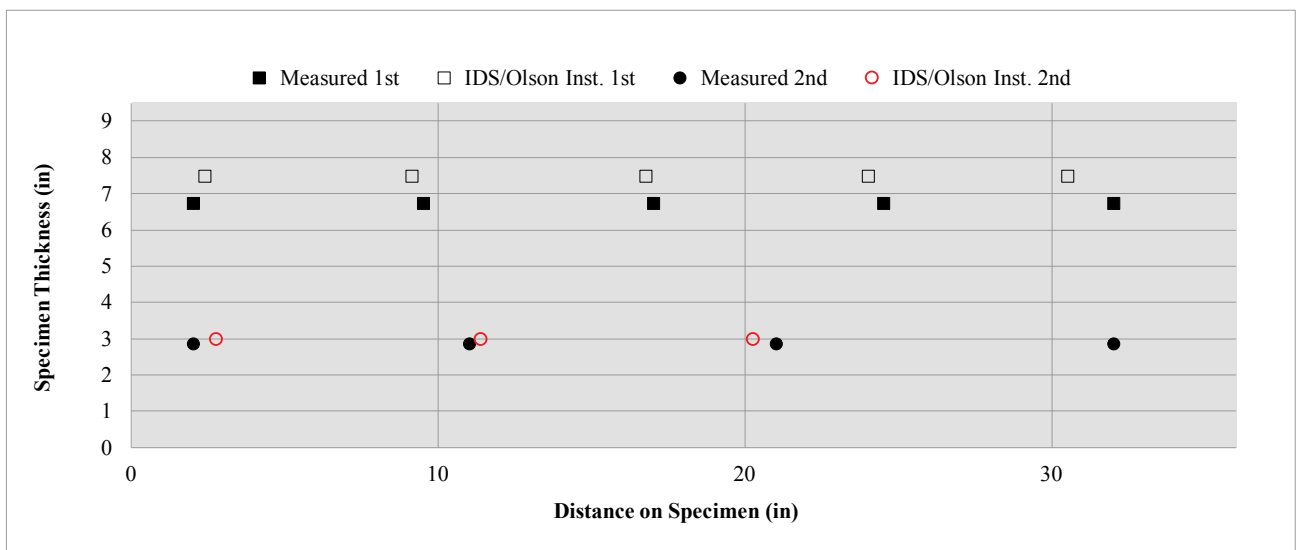

(b) Longitudinal Rebars

*Red measurements are referred to rebar positions for which it was not reported concrete coverage.

Figure 5.72. IDS/Olson Instruments On-Site Results for 9.5-inch Thickness Reinforced Specimen (Big Rebars).

10-inches Thickness Reinforced Specimen

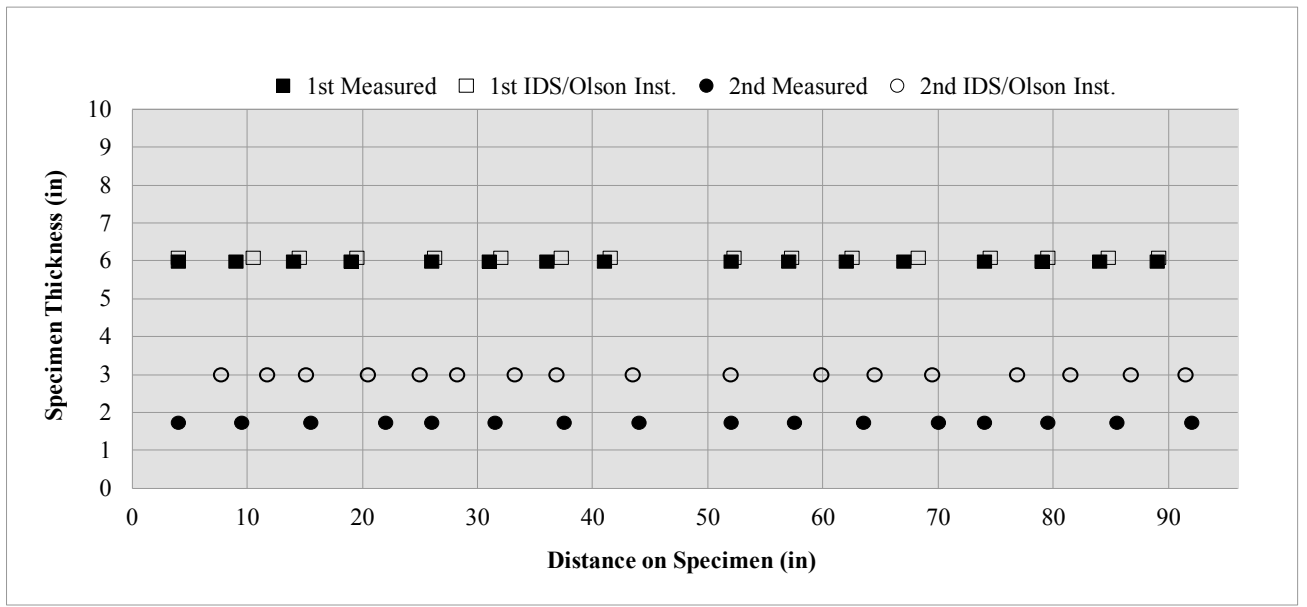

(a) Transverse Rebars

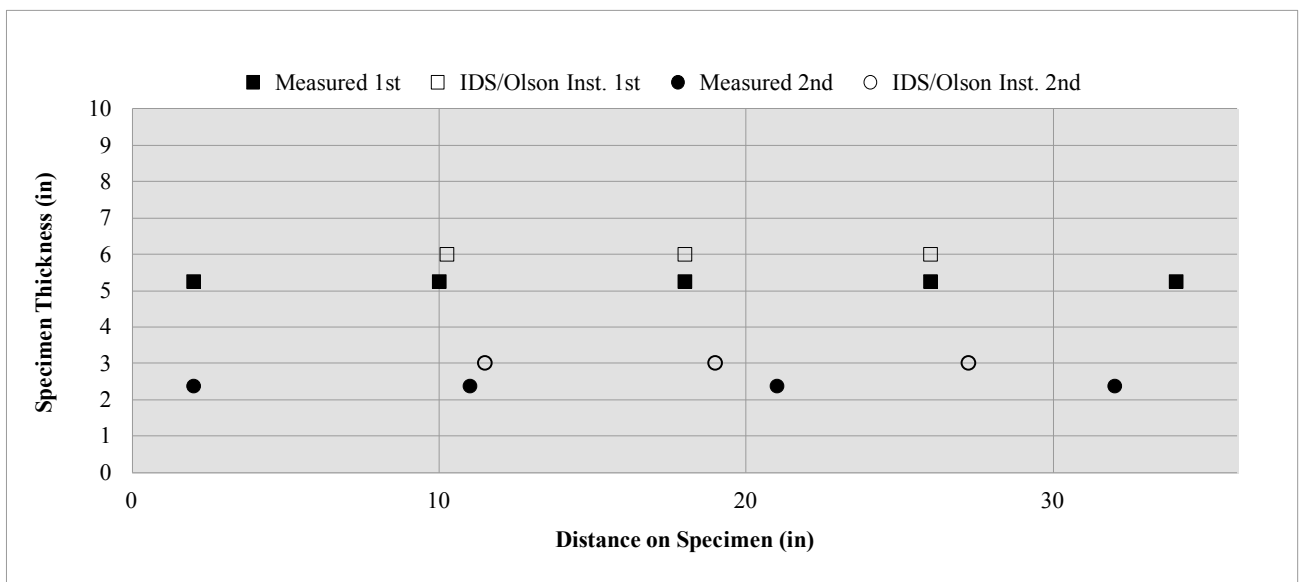

(b) Longitudinal Rebars

Figure 5.73. IDS/Olson Instruments On-Site Results for 10-inch Thickness Reinforced Specimen.

10-inches Thickness Reinforced Specimen Elevated

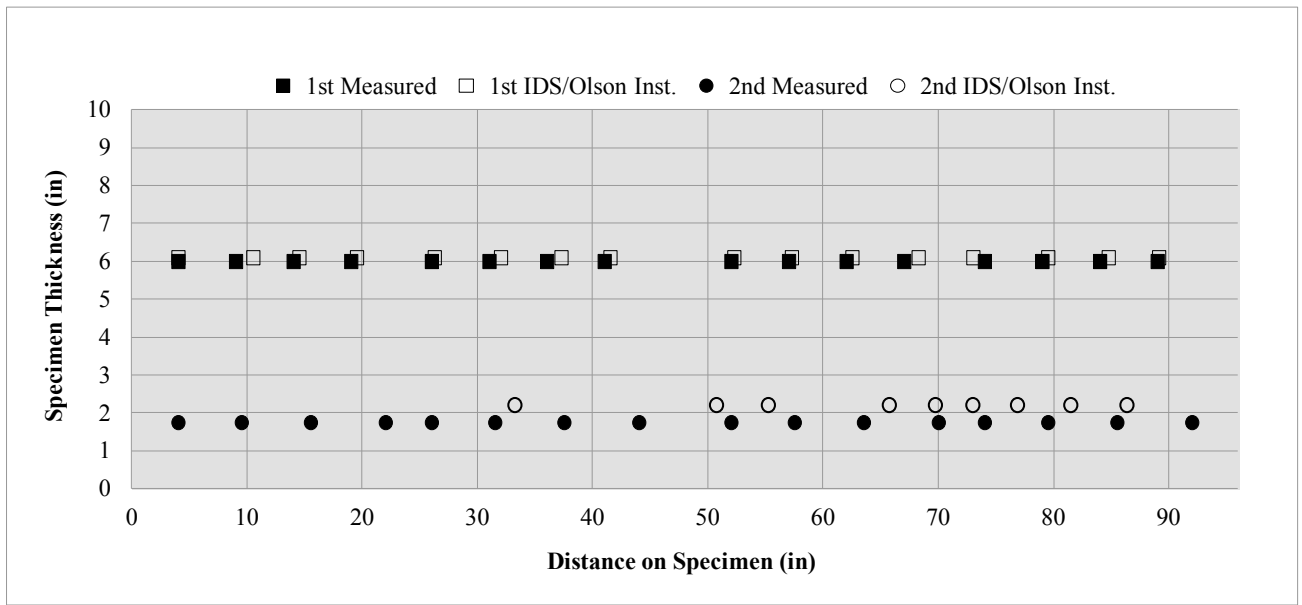

(a) Transverse Rebars

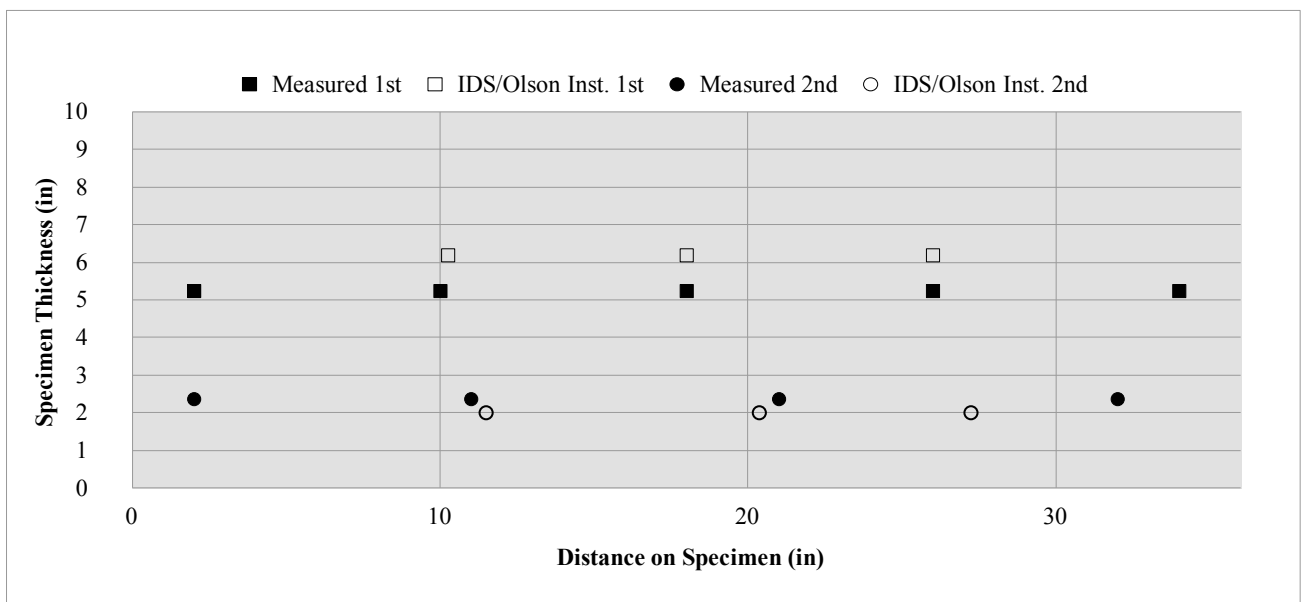

(b) Longitudinal Rebars

Figure 5.74. IDS/Olson Instruments On-Site Results for 10-inch Thickness Reinforced Specimen Elevated .

Post-Processed Olson Engineering Rebars Detection

Following, the post-processed data from each block with identification of upper and lower rebars is reported (Figures 5.75 to 5.86). Also, the rebars positions determined after post processing the data collected with the GPR device from Olson Engineering are illustrated for an effective comparison of the exact and estimated steel locations.

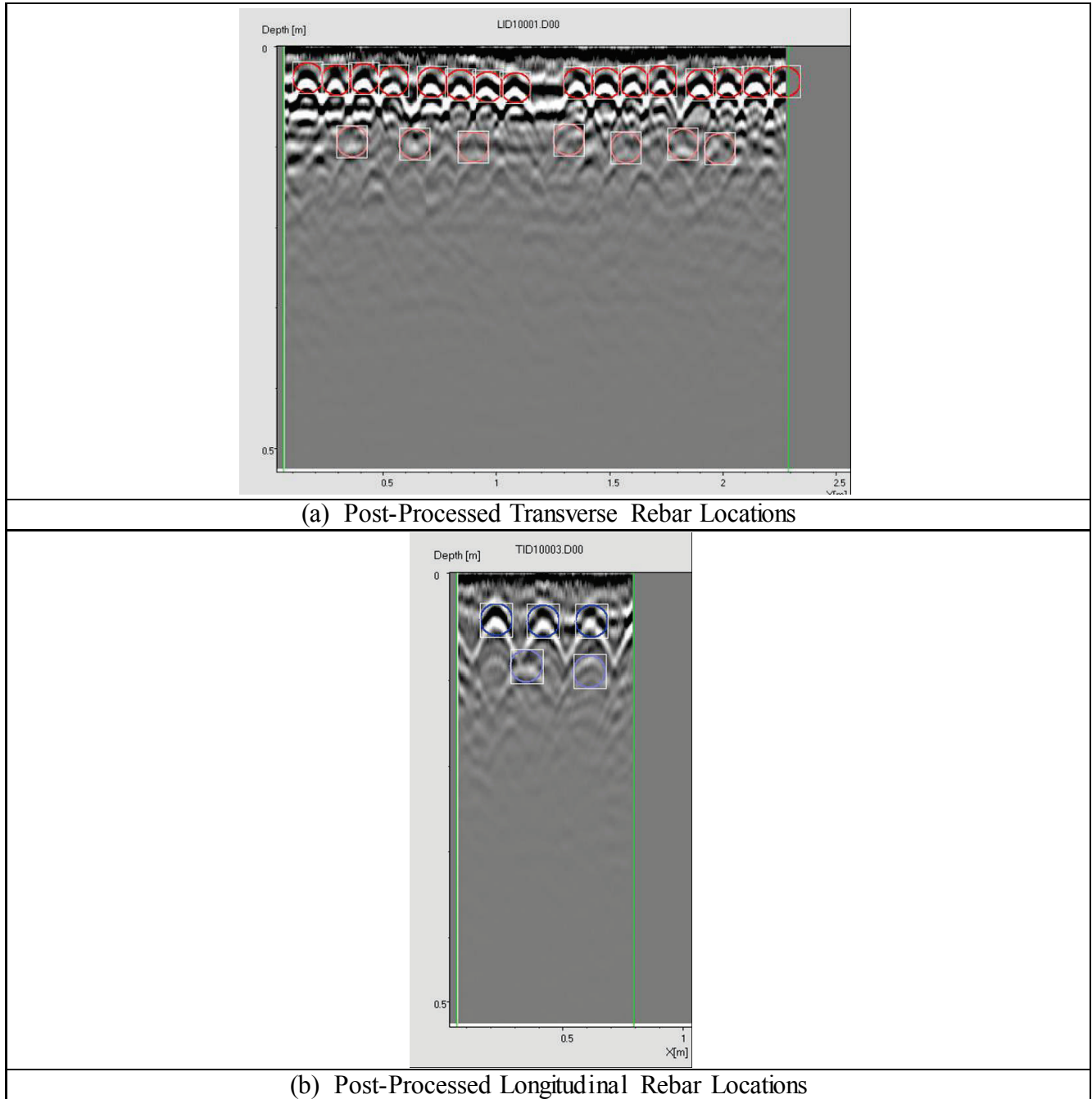
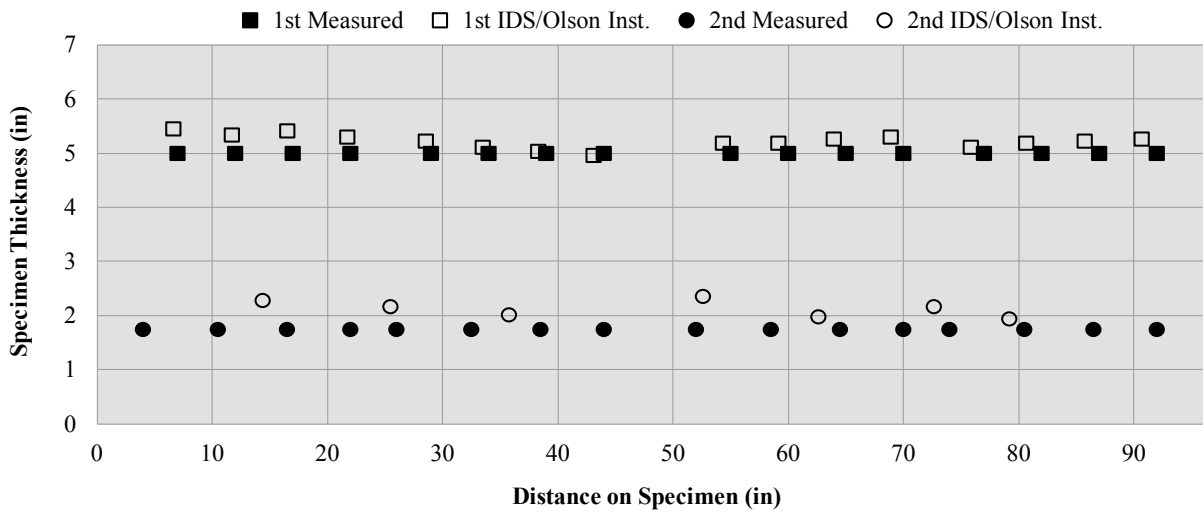
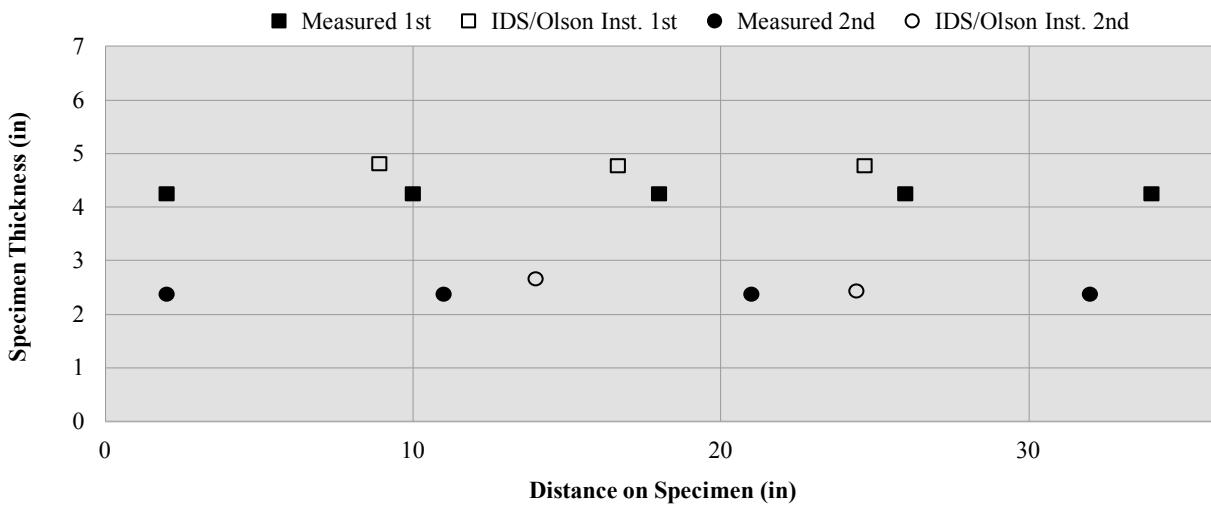

Figure 5.75. IDS/Olson Instruments Screenshots From Post-Processed Data of 7-inch Thick Block Results.

7-inches Thickness Reinforced Specimen



(a) Transverse Rebars



(b) Longitudinal Rebars

Figure 5.76. IDS/Olson Instruments Post-processed Results for 7-inch Thickness Reinforced Specimen.

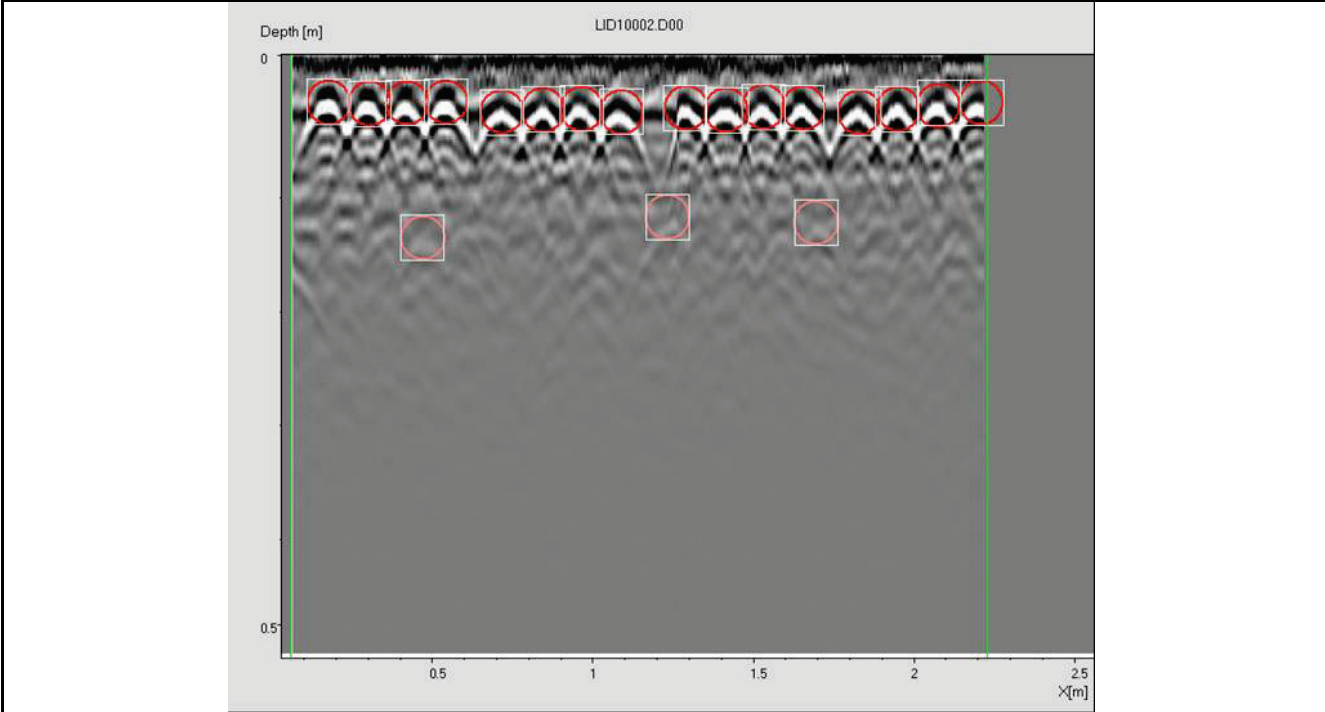

(a) Post-Processed Transverse Rebar Locations

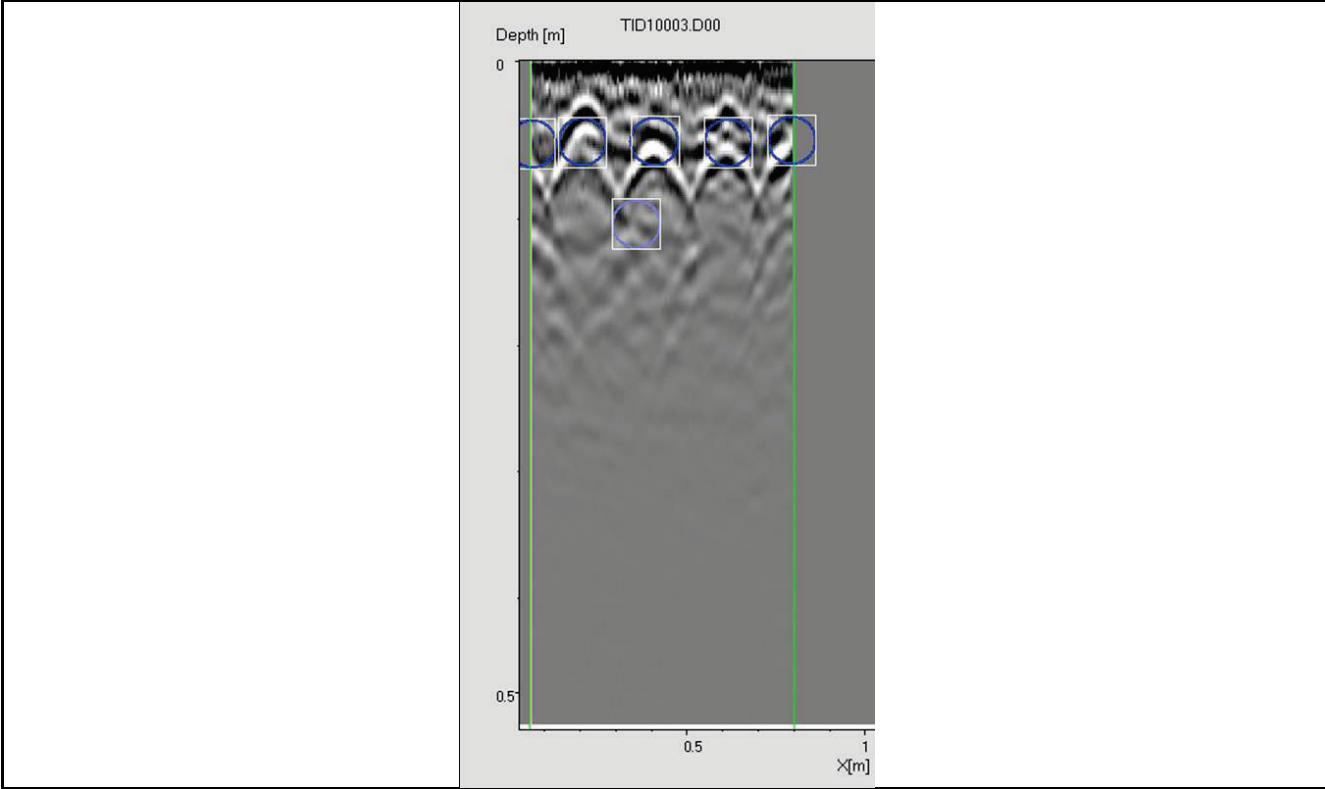

(b) Post-Processed Longitudinal Rebar Locations

Figure 5.77. IDS/Olson Instruments Screenshots From Post-Processed Data of 8-inch Thick Block Results.

8-inches Thickness Reinforced Specimen

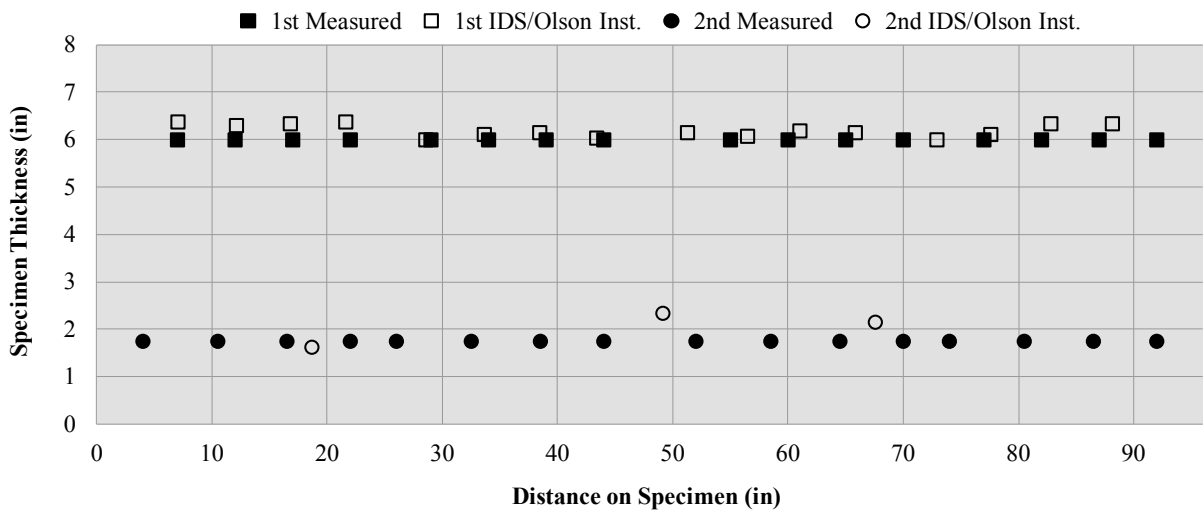

(a) Transverse Rebars

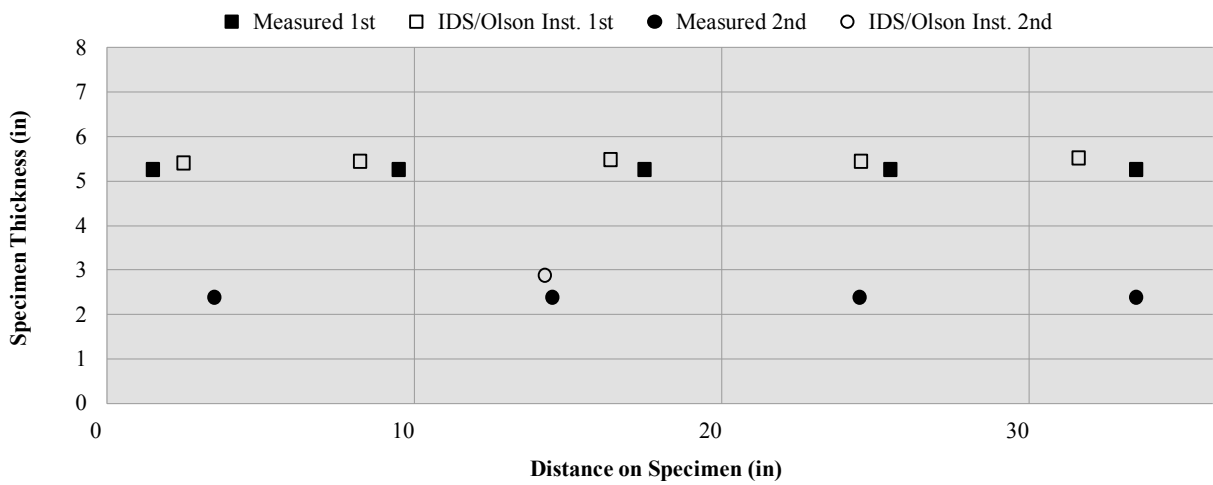

(b) Longitudinal Rebars

Figure 5.78. IDS/Olson Instruments Post-processed Results for 8-inch Thickness Reinforced Specimen.

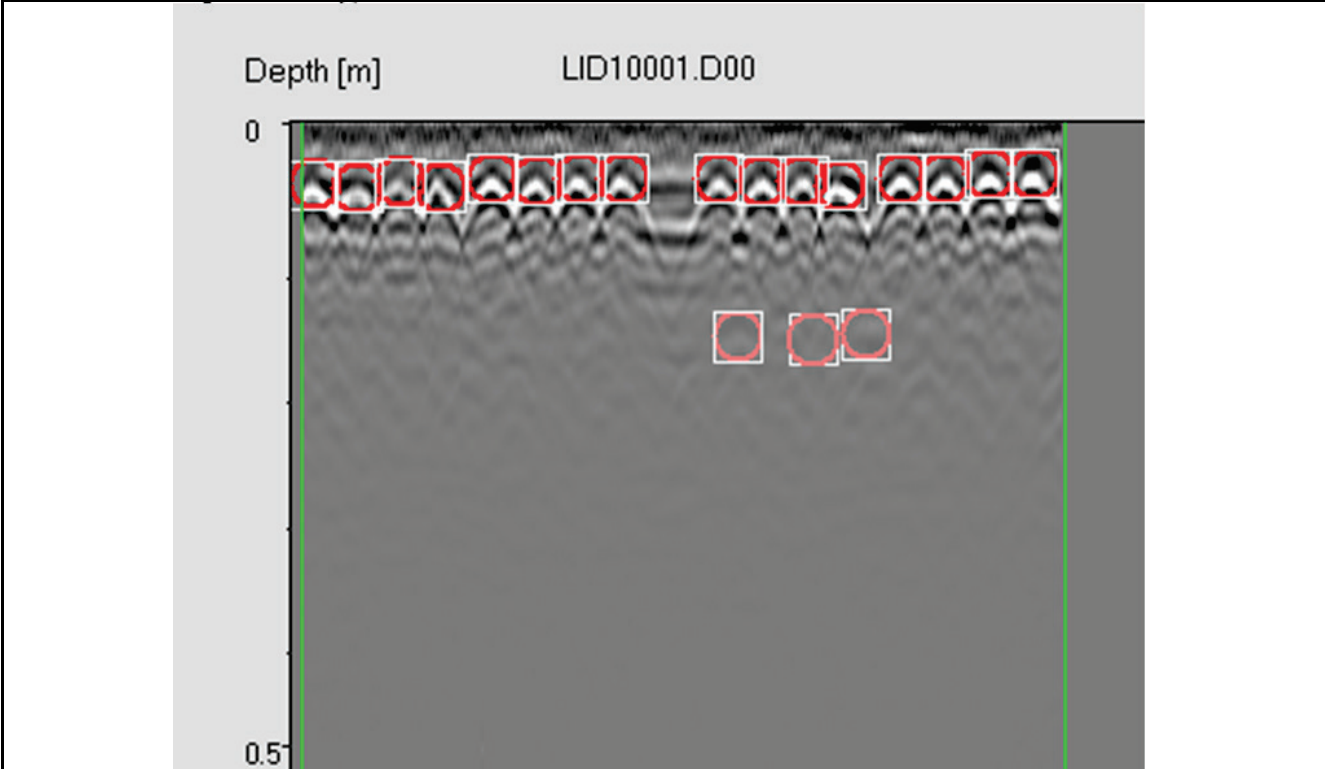

(a) Post-Processed Transverse Rebar Locations

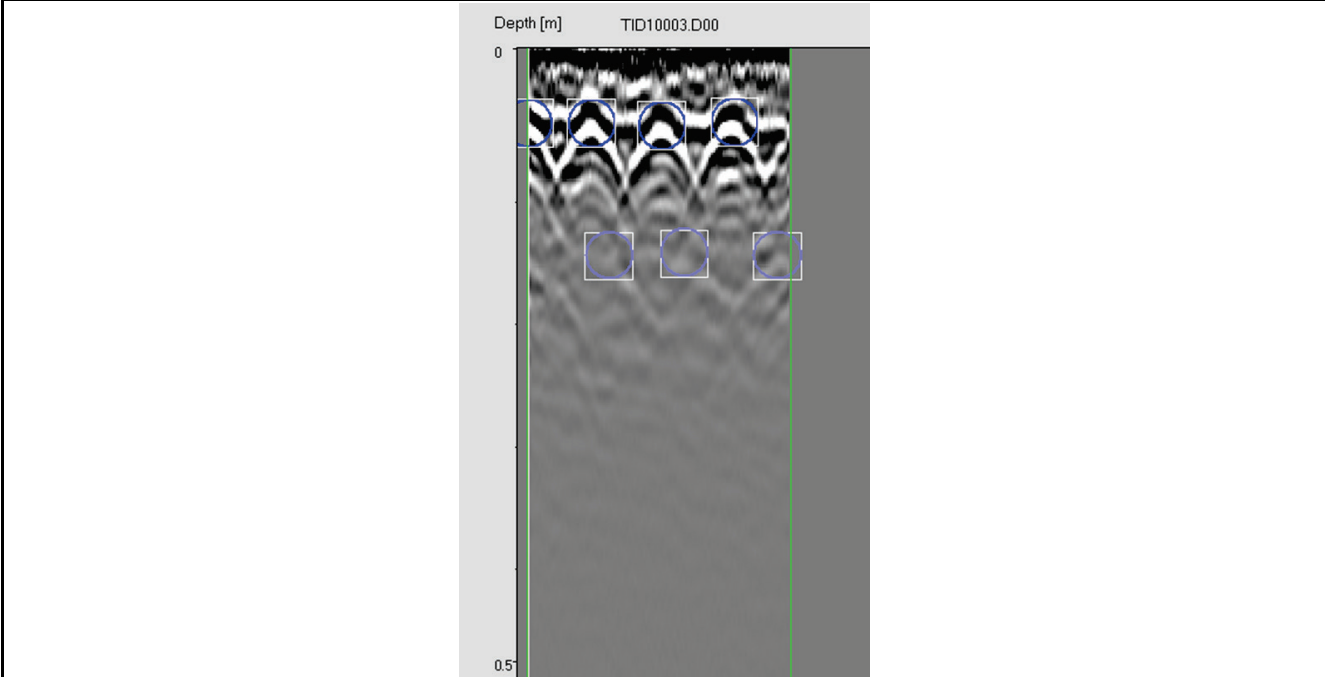

(b) Post-Processed Longitudinal Rebar Locations

Figure 5.79. IDS/Olson Instruments Screenshots From Post-Processed Data of 9.5-inch Thick Block Results (Small Rebars).

9.5-inches Thickness Reinforced Specimen (Small Rebars)

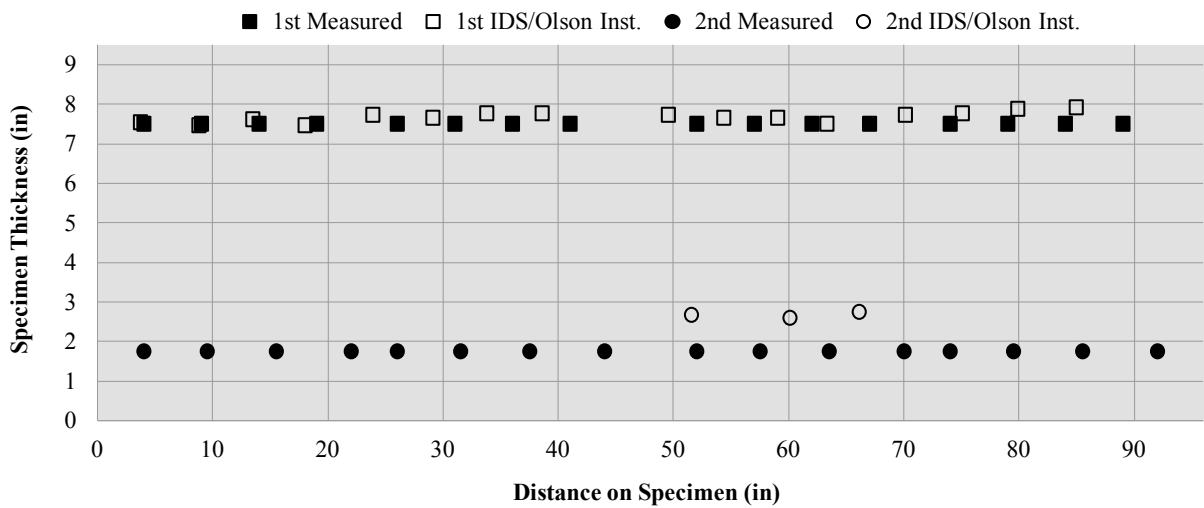

(a) Transverse Rebars

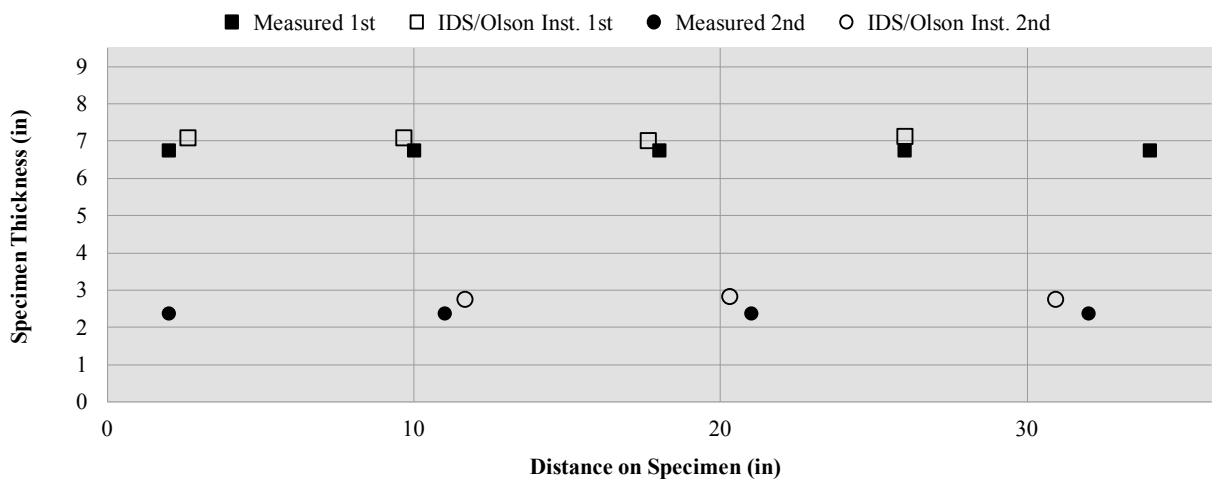

(b) Longitudinal Rebars

Figure 5.80. IDS/Olson Instruments Post-processed Results for 9.5-inch Thickness Reinforced Specimen (Small Rebars).

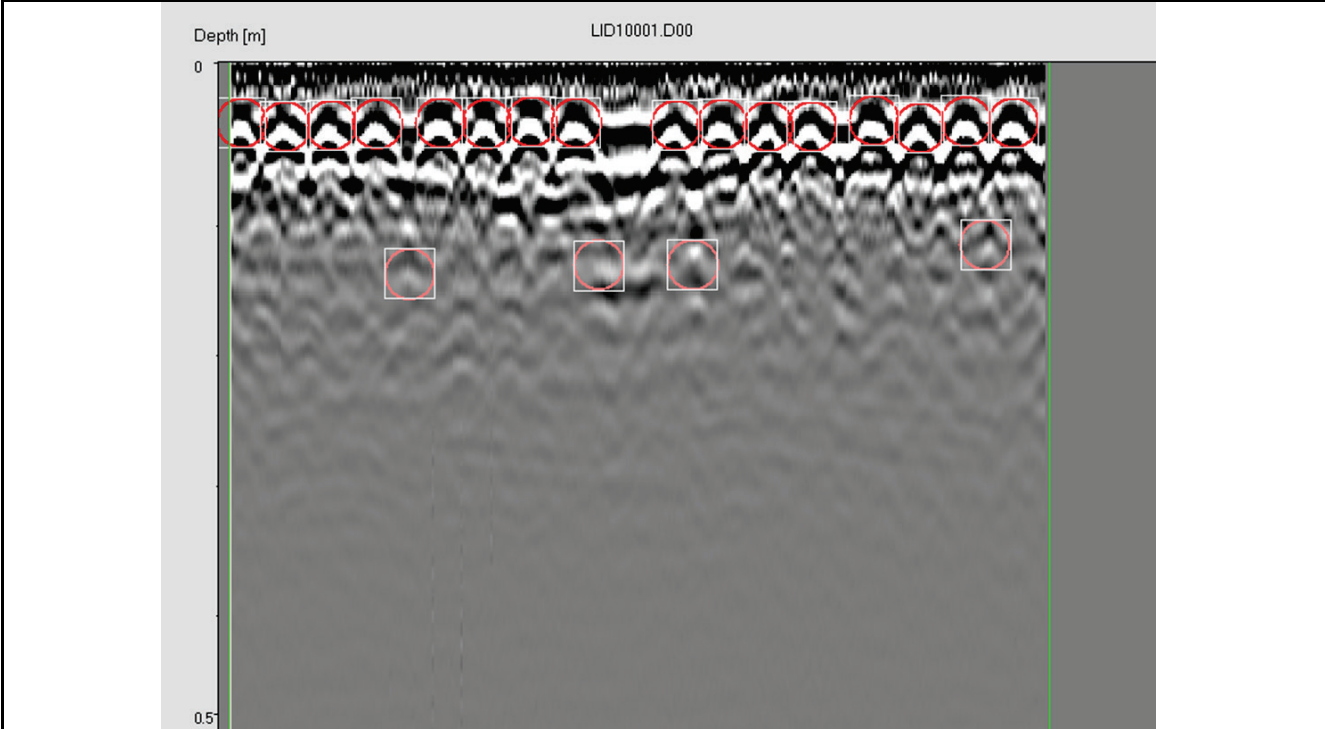

(a) Post-Processed Transverse Rebar Locations

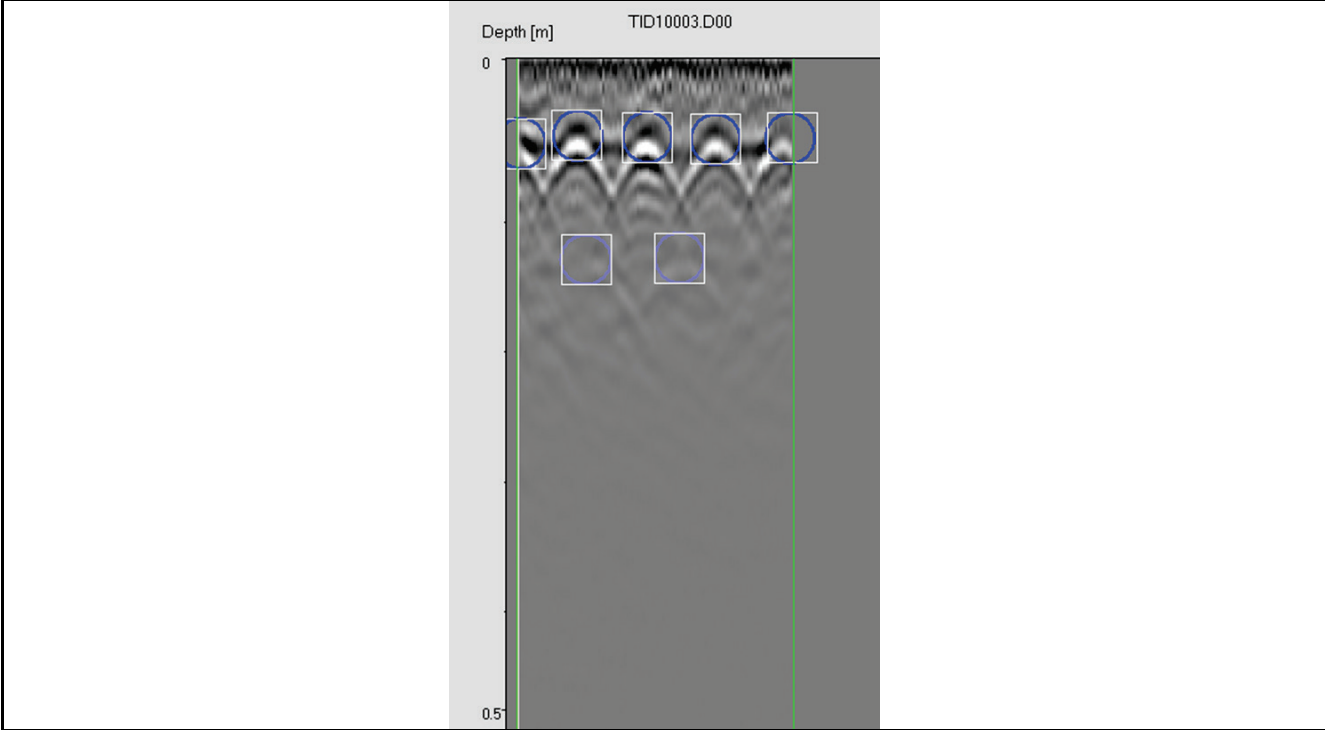

(b) Post-Processed Longitudinal Rebar Locations

Figure 5.81. IDS/Olson Instruments Screenshots From Post-Processed Data of 9.5-inch Thick Block Results (Big Rebars).

9.5-inches Thickness Reinforced Specimen (Big Rebars)

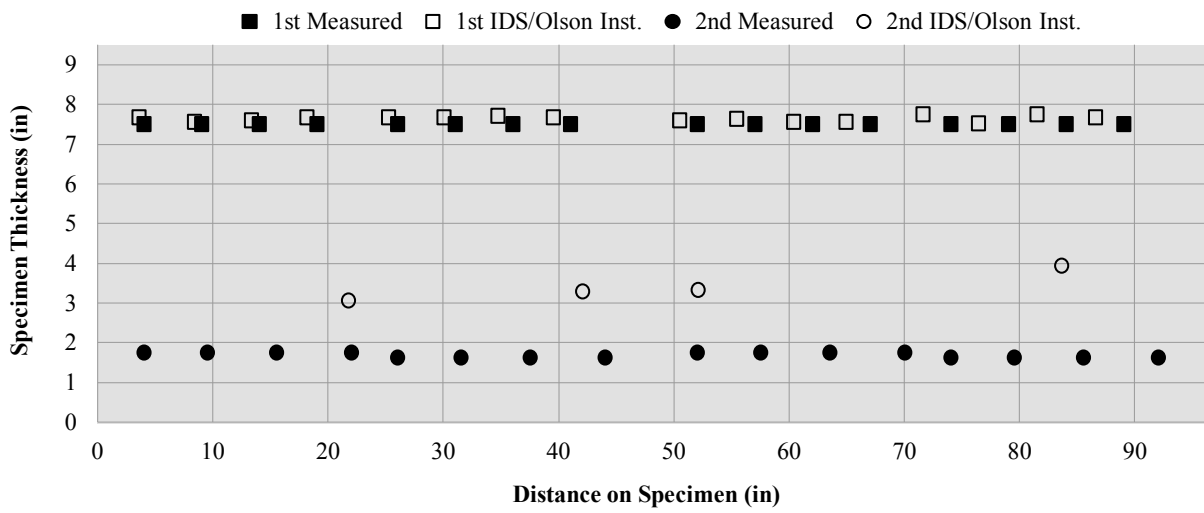

(a) Transverse Rebars

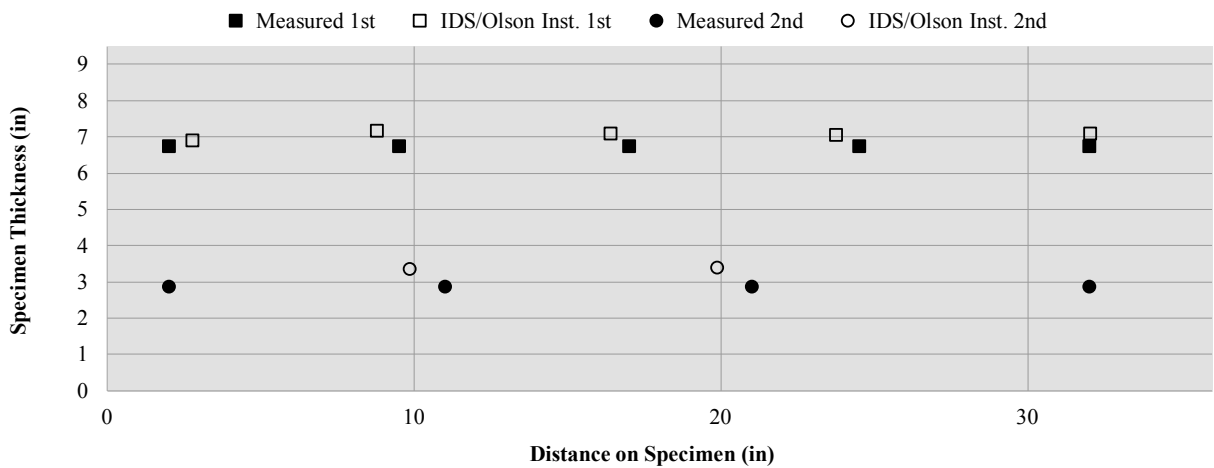

(b) Longitudinal Rebars

Figure 5.82. IDS/Olson Instruments Post-processed Results for 9.5-inch Thickness Reinforced Specimen (Big Rebars).

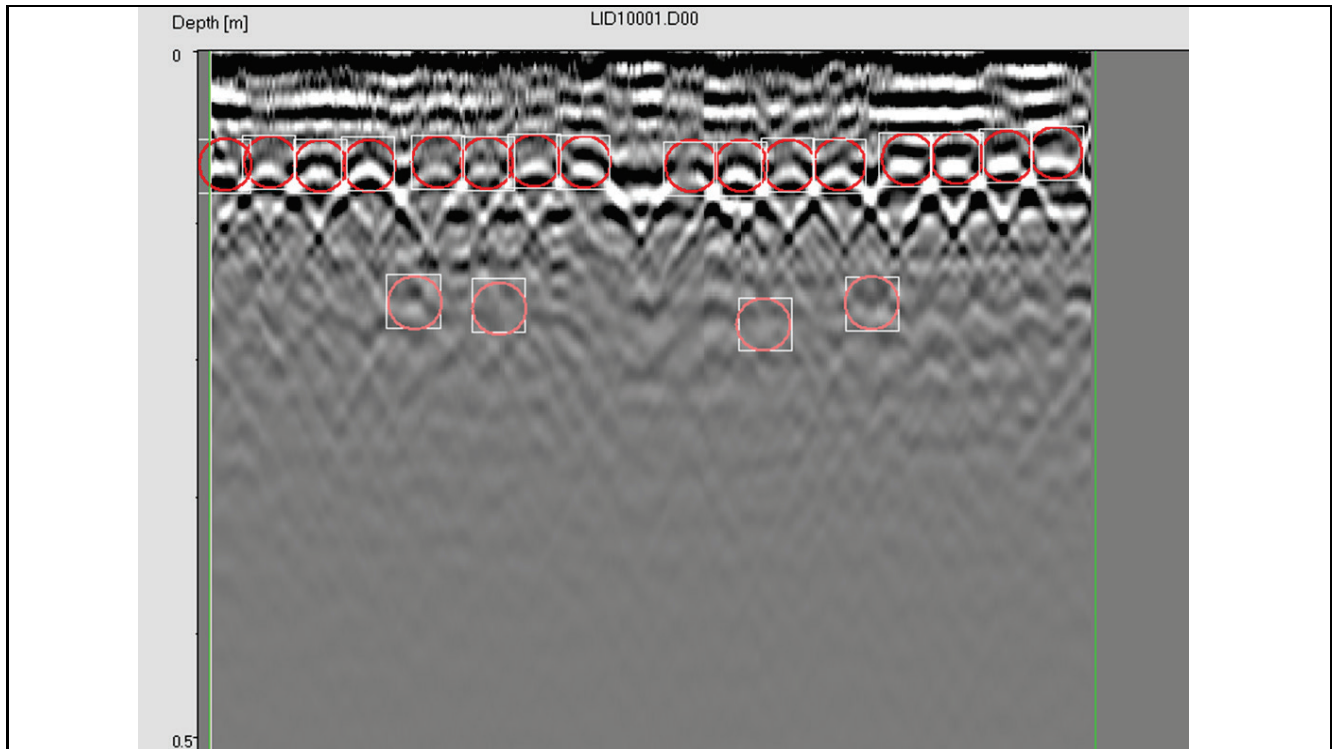

(a) Post-Processed Transverse Rebar Locations

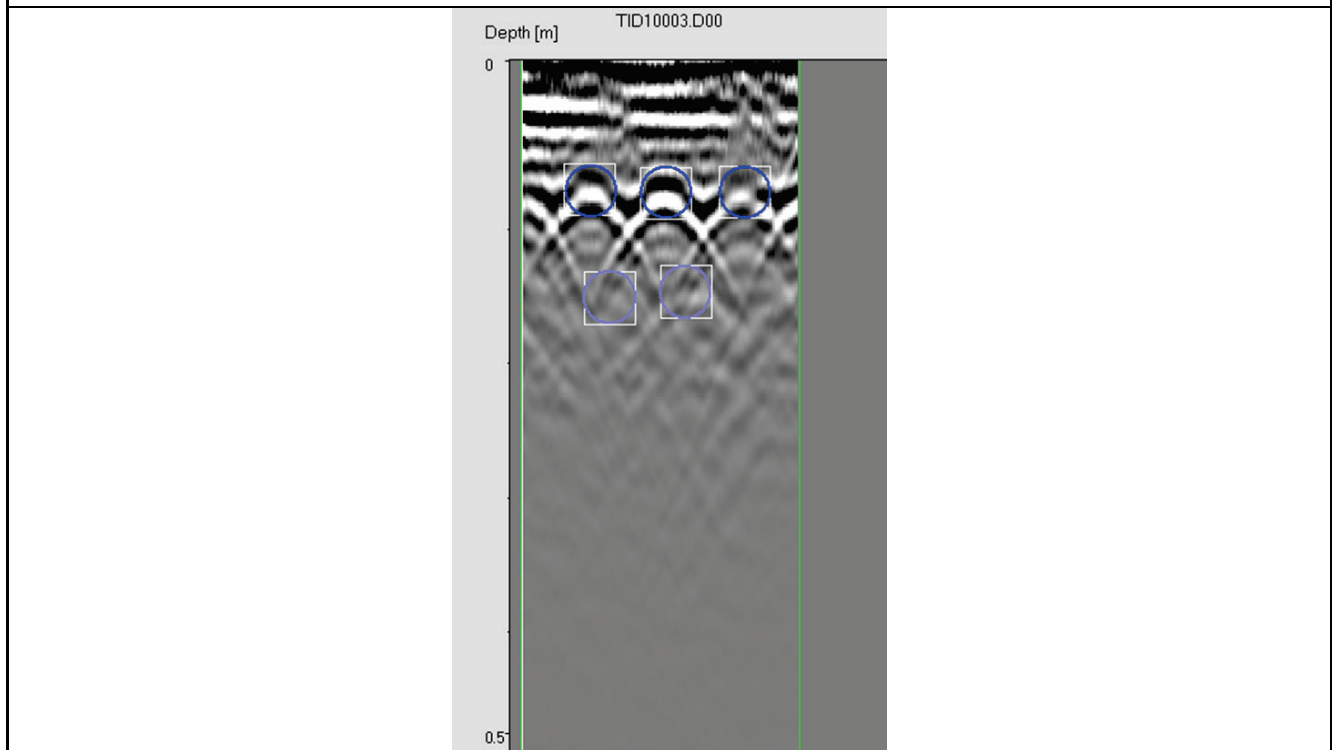

(b) Post-Processed Longitudinal Rebar Locations

Figure 5.83. IDS/Olson Instruments Screenshots From Post-Processed Data of 10-inch Thick Block Results.

10-inches Thickness Reinforced Specimen

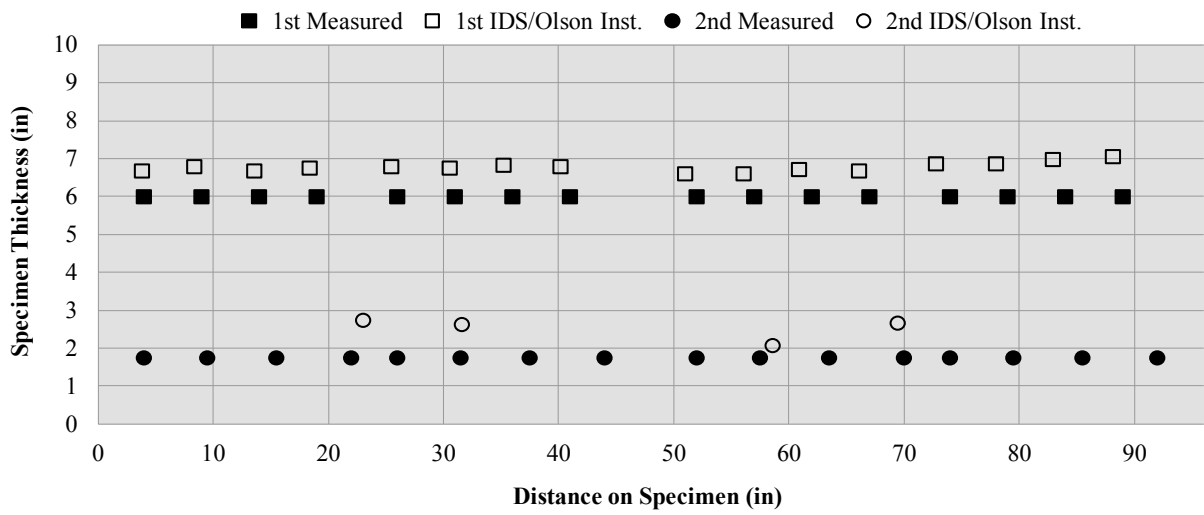

(a) Transverse Rebars

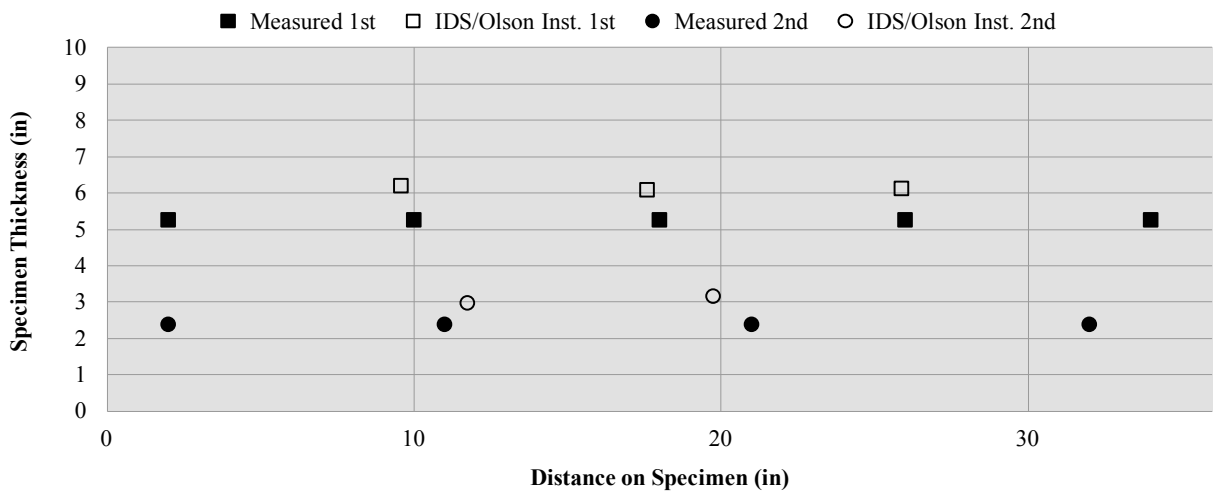

(b) Longitudinal Rebars

Figure 5.84. IDS/Olson Instruments Post-processed Results for 10-inch Thickness Reinforced Specimen.

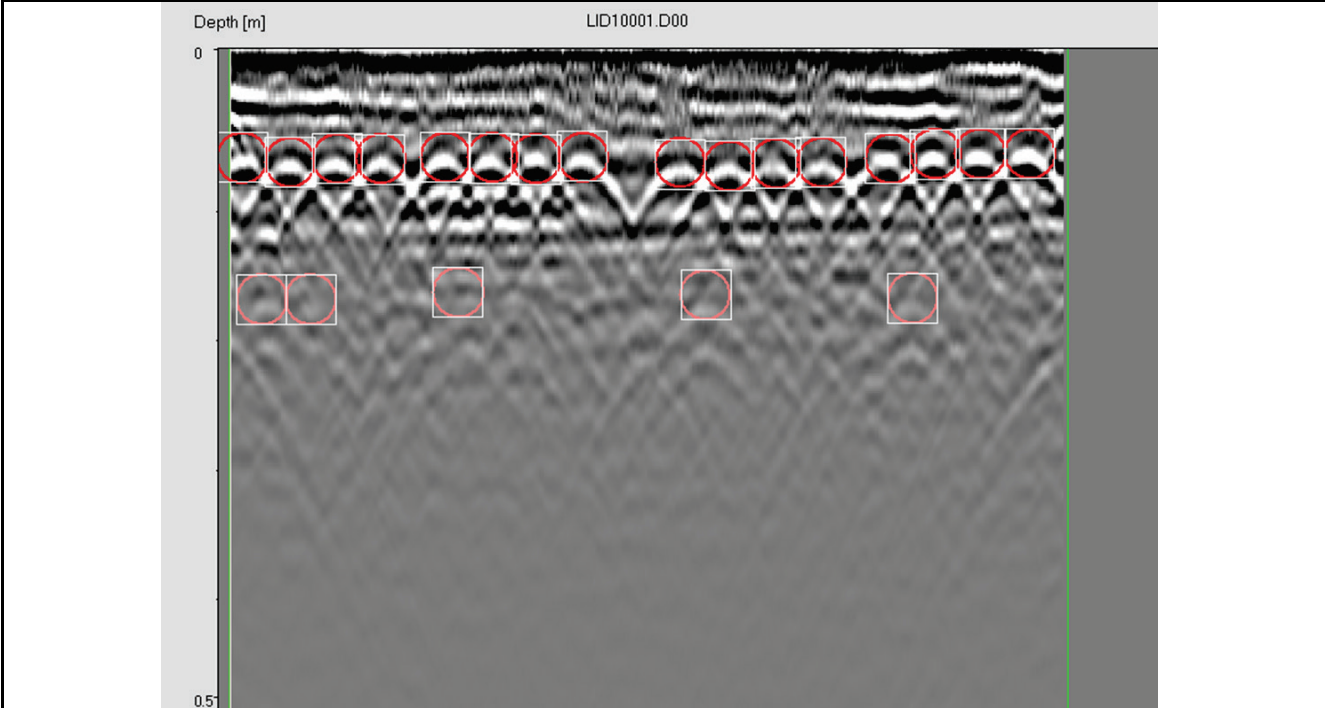

(a) Post-Processed Transverse Rebar Locations

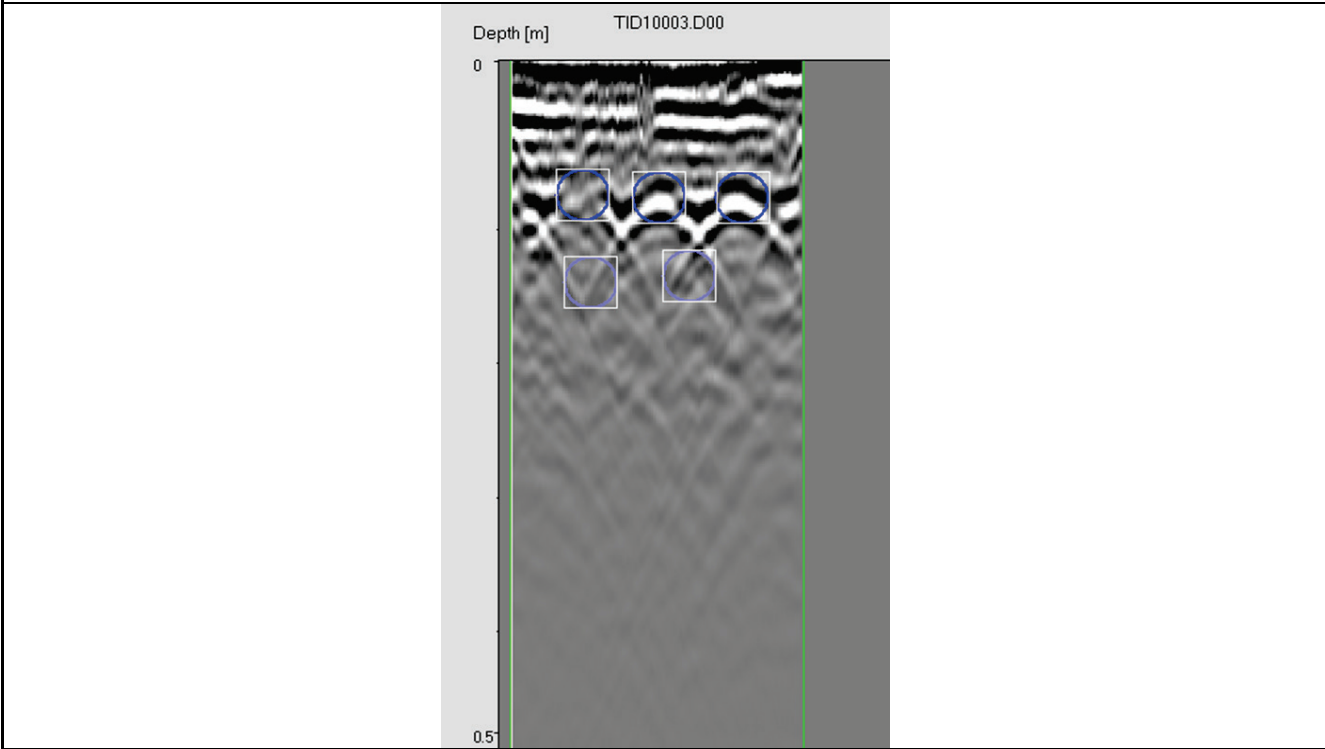

(b) Post-Processed Longitudinal Rebar Locations

Figure 5.85. IDS/Olson Instruments Screenshots From Post-Processed Data of 10-inch Thick Elevated Block Results.

10-inches Thickness Reinforced Specimen Elevated

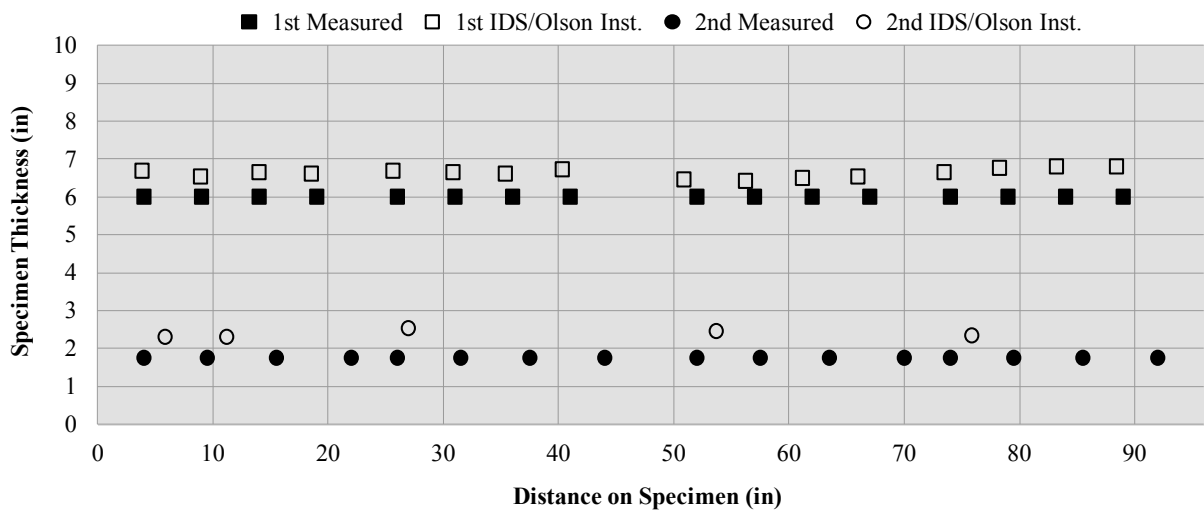

(a) Transverse Rebars

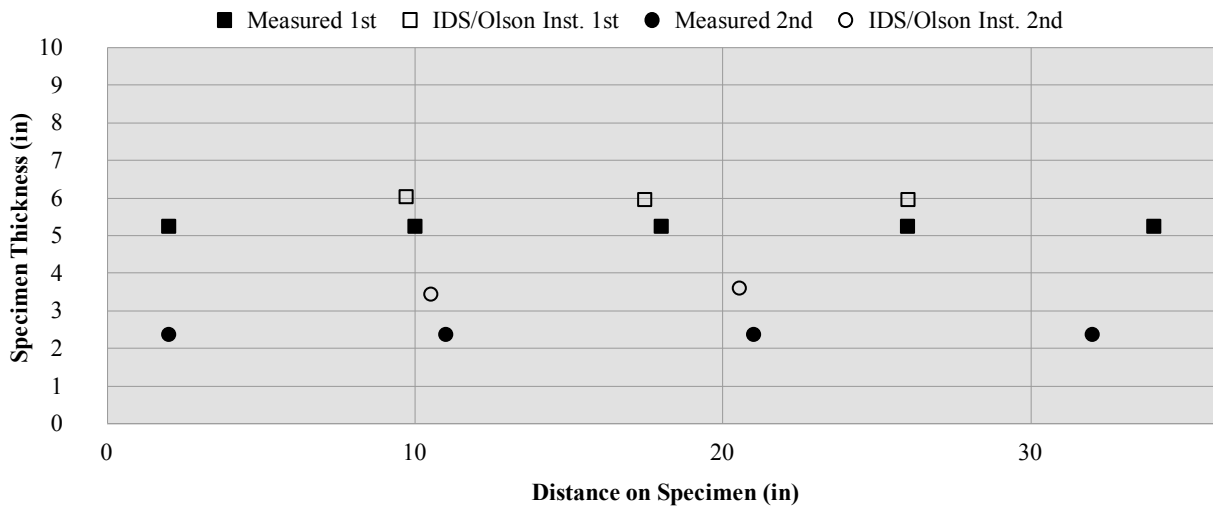

(b) Longitudinal Rebars

Figure 5.86. IDS/Olson Instruments Post-processed Results for 10-inch Thickness Reinforced Specimen Elevated.

COVERMETERS RESULTS

Proceq (Profoscope⁺)

Details on the characteristics and use of the Profoscope⁺ Proceq device are reported in Appendix G. Following, the data obtained from scanning of the reinforced concrete specimens with Proceq Profoscope⁺ covermeter device are reported (Figures 5.87 to 5.90).

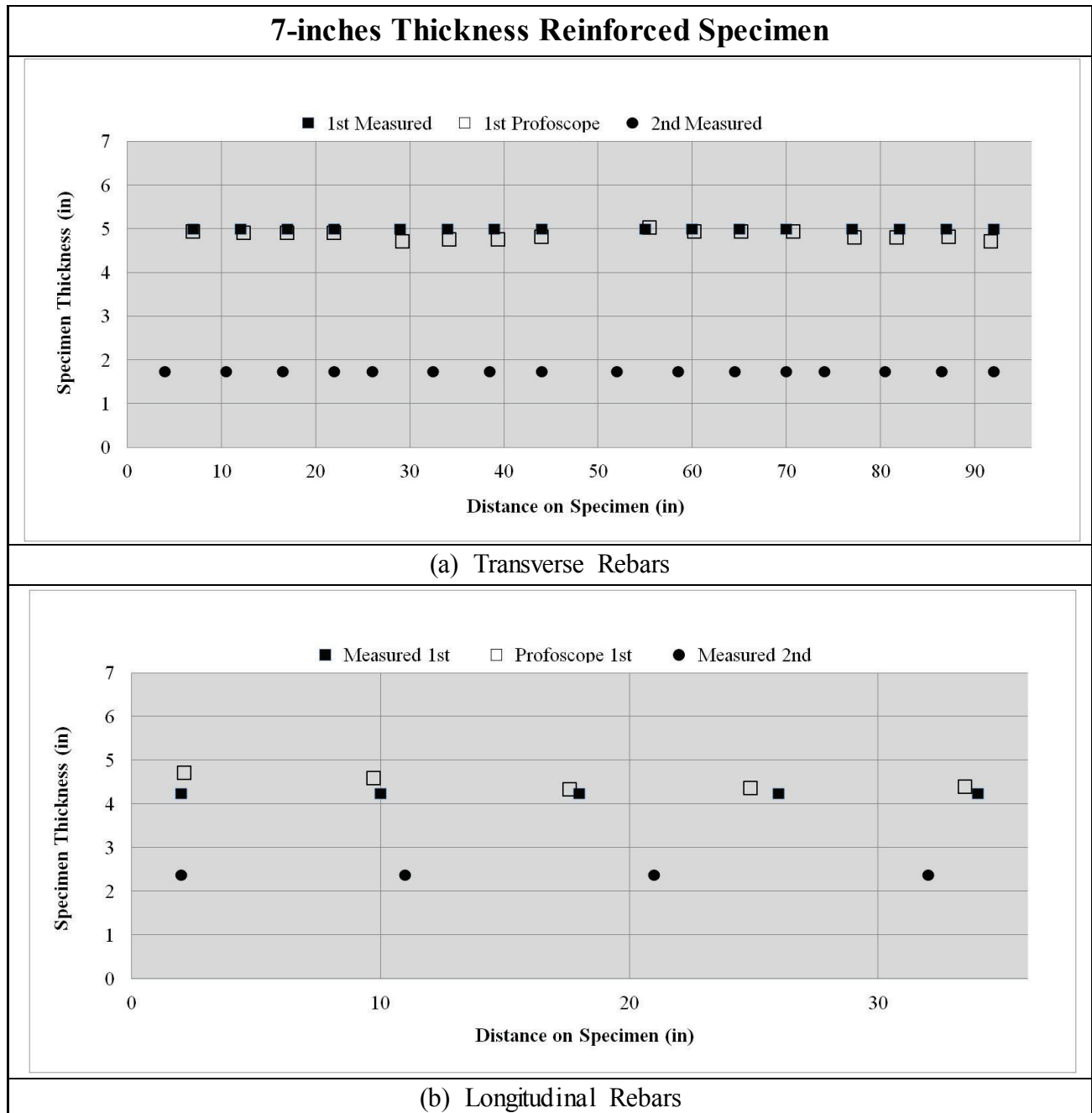
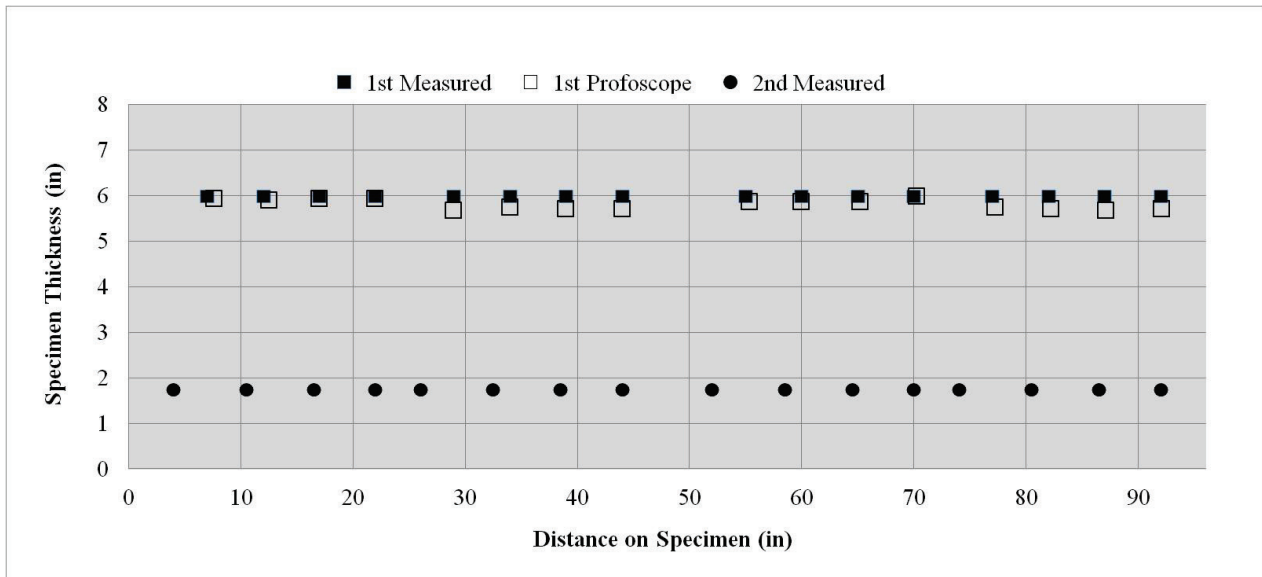
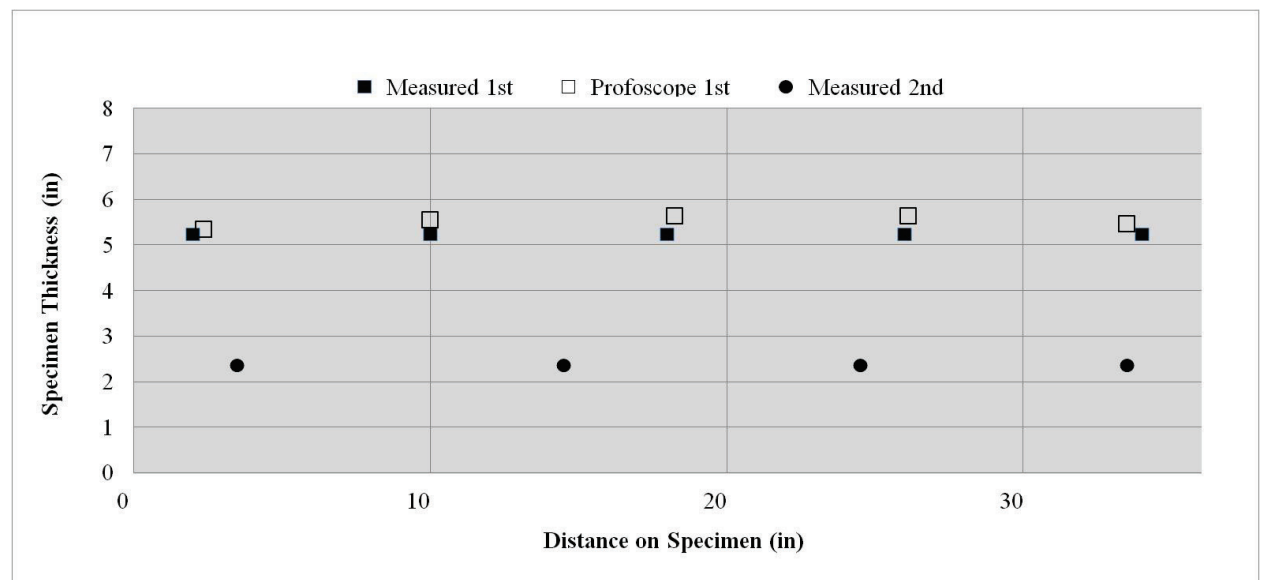

Figure 5.87. Proceq (Profoscope⁺) Results for 7-inch Thickness Reinforced Specimen.

8-inches Thickness Reinforced Specimen



(a) Transverse Rebars



(b) Longitudinal Rebars

Figure 5.88. Proceq (Profoscope⁺) Results for 8-inch Thickness Reinforced Specimen.

9.5-inches Thickness Reinforced Specimen (Small Rebars)

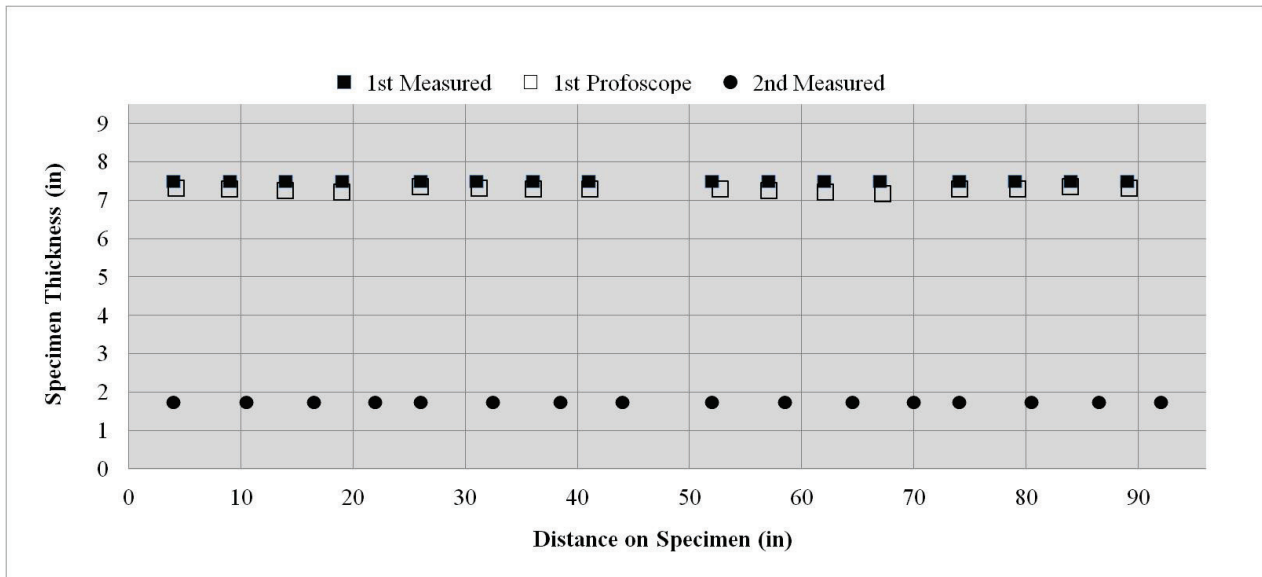

(a) Transverse Rebars

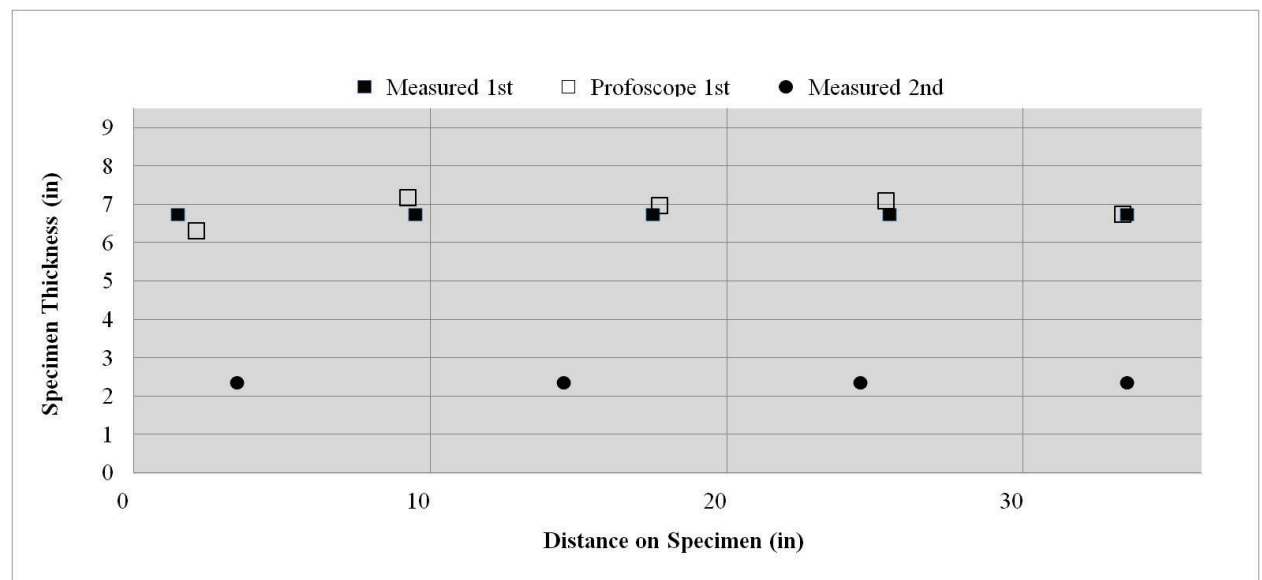

(b) Longitudinal Rebars

Figure 5.89. Proceq (Profoscope⁺) Results for 9.5-inch Thickness Reinforced Specimen (Small Rebars).

9.5-inches Thickness Reinforced Specimen (Big Rebars)

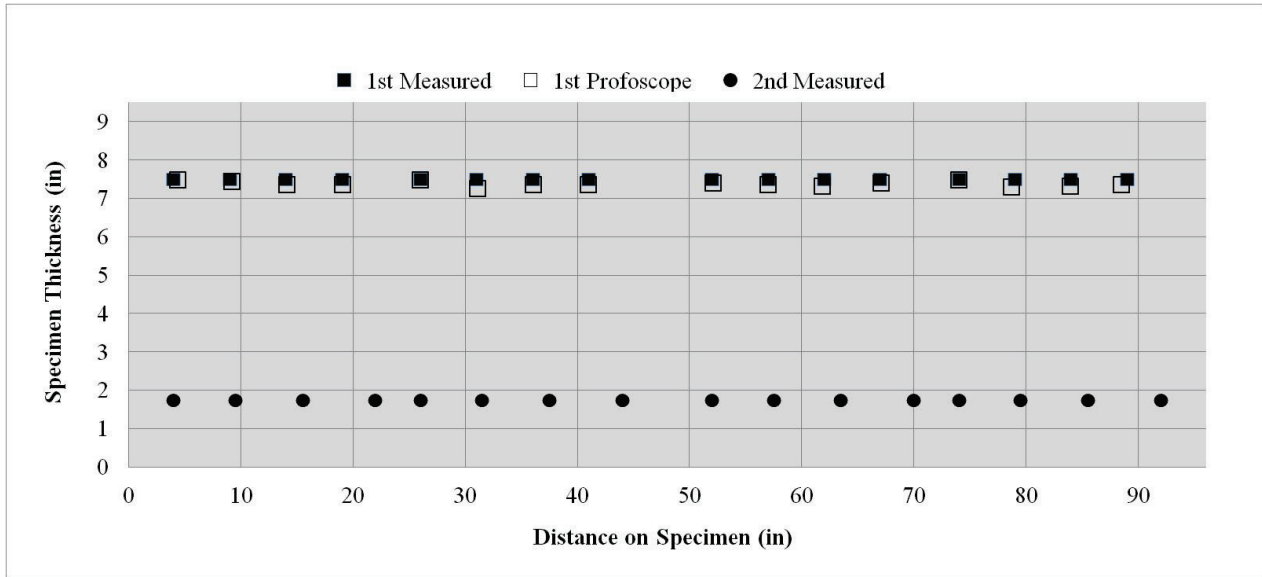

(a) Transverse Rebars

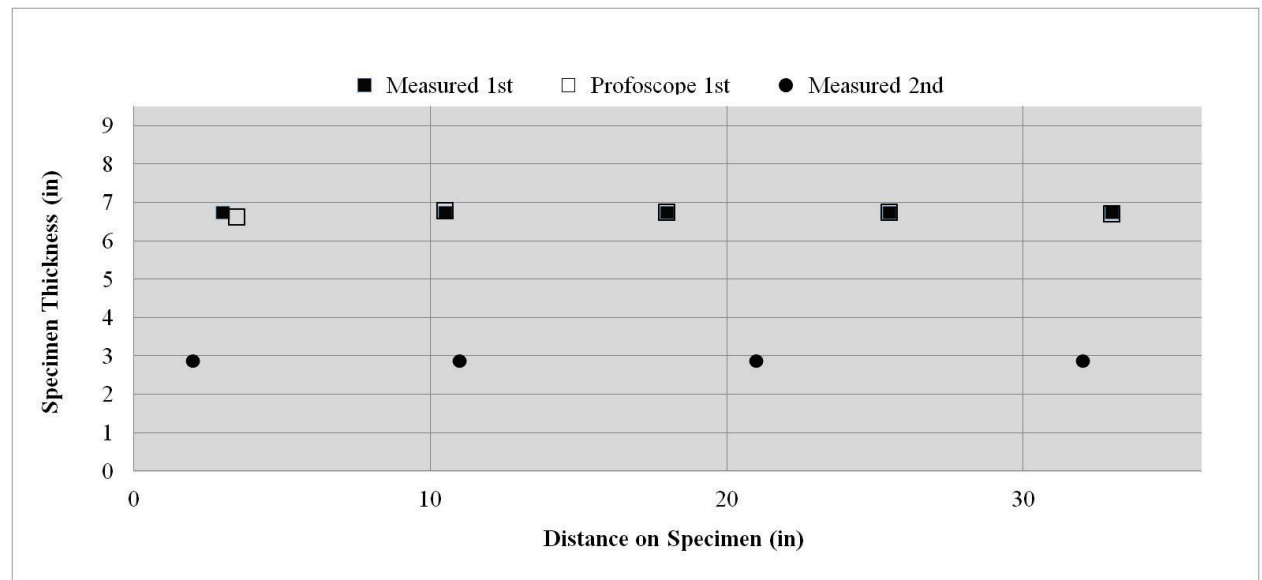

(b) Longitudinal Rebars

Figure 5.90. Proceq (Profoscope⁺) Results for 9.5-inch Thickness Reinforced Specimen (Big Rebars).

Proceq (Profometer 5⁺)

Details on the characteristics and use of the Profoscope5⁺ Proceq device are reported in Appendix H. Following, the data obtained from scanning of the reinforced concrete specimens with Proceq Profometer 5⁺ covermeter device are reported (Figures 5.91 to 5.94).

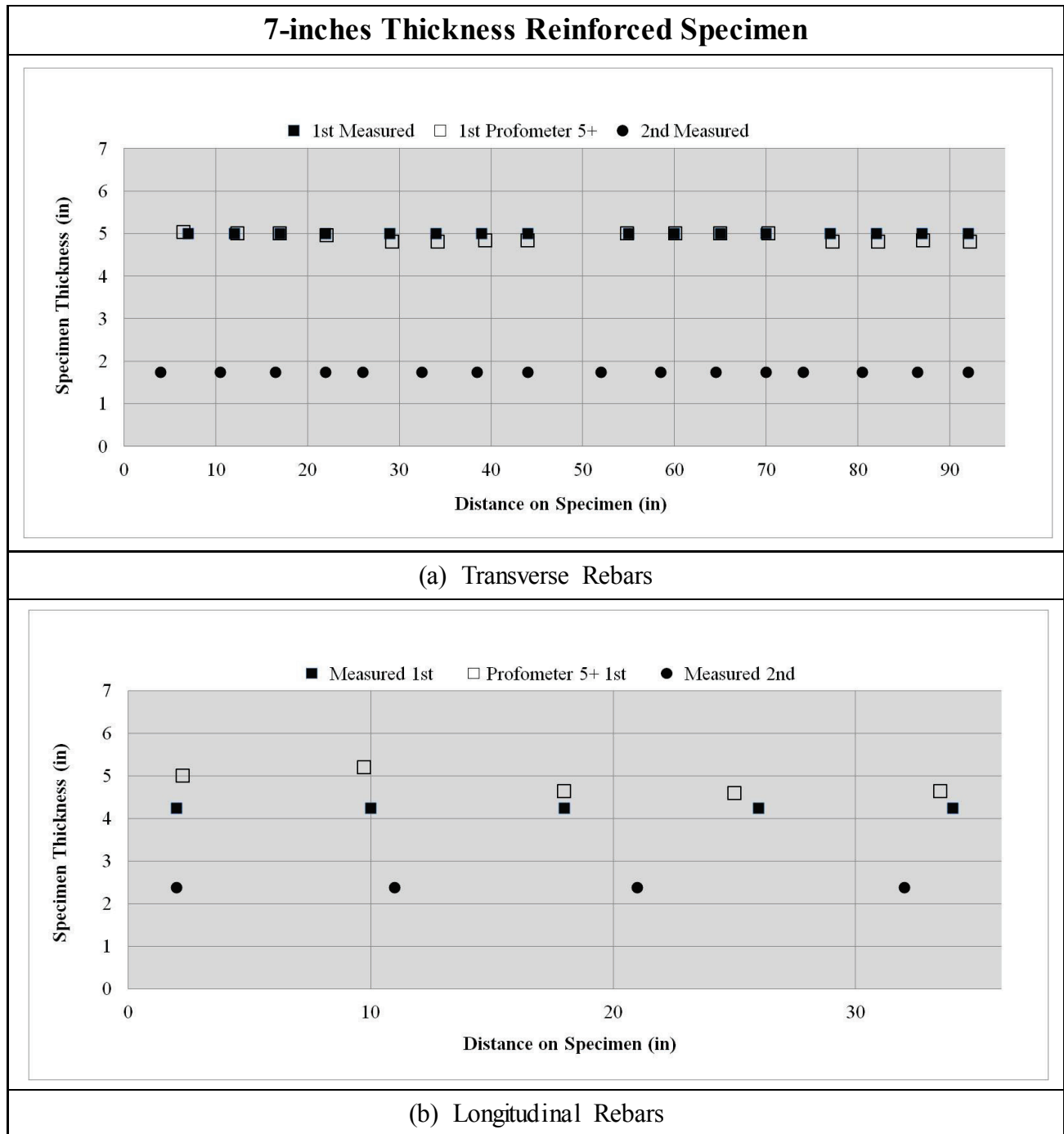
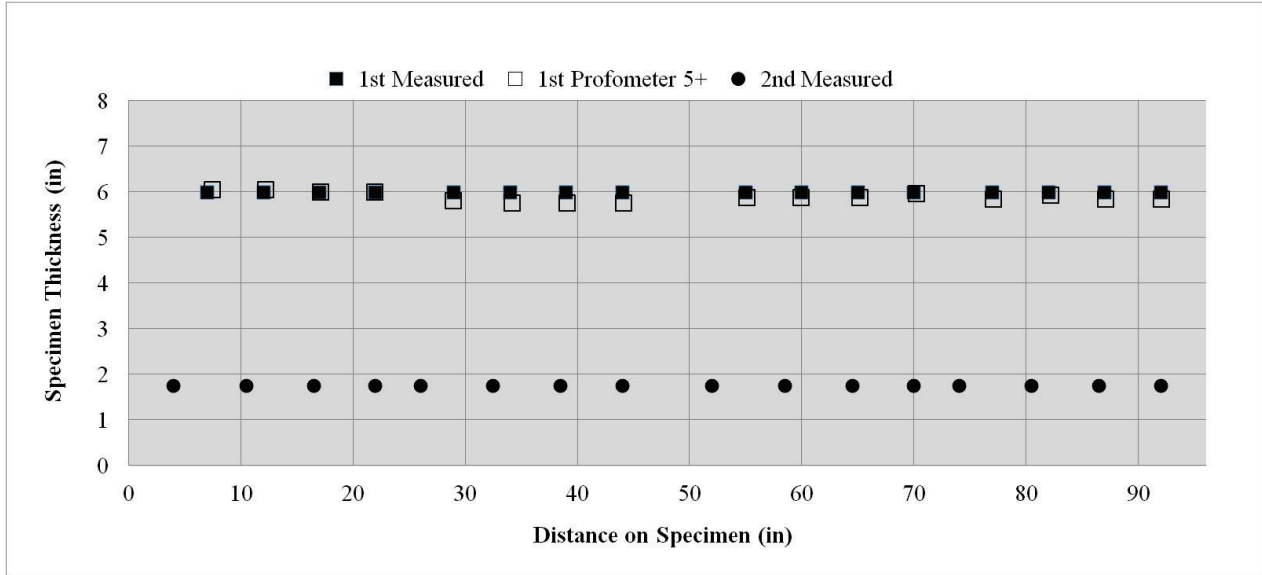
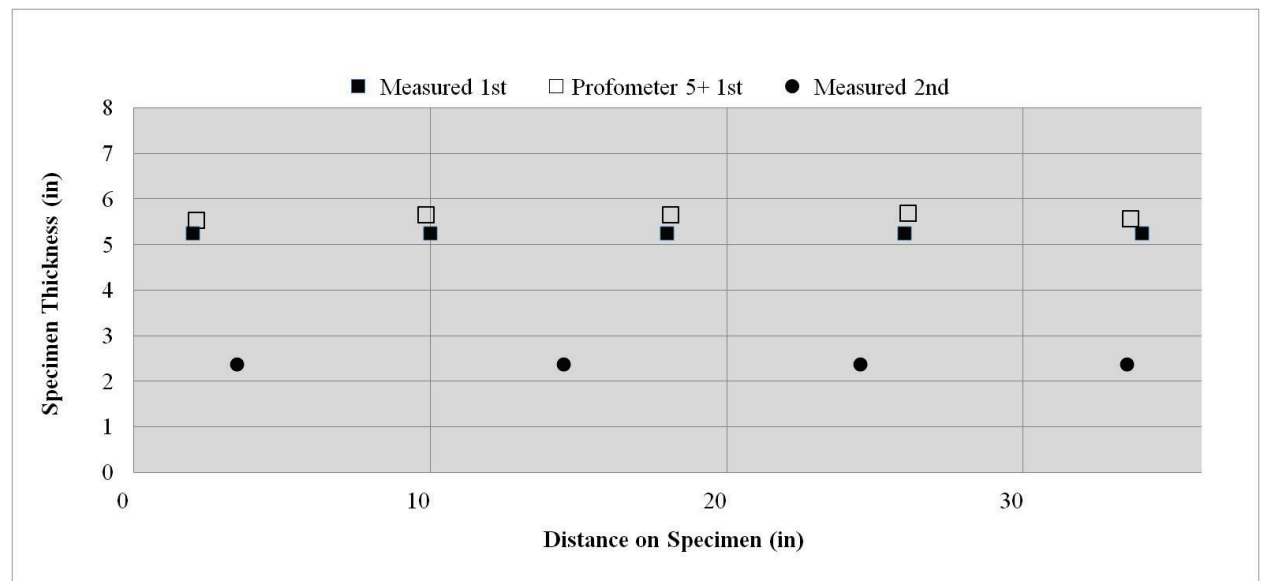

Figure 5.91. Proceq (Profometer 5⁺) Results for 7-inch Thickness Reinforced Specimen.

8-inches Thickness Reinforced Specimen



(a) Transverse Rebars



(b) Longitudinal Rebars

Figure 5.92. Proceq (Profometer 5+) Results for 8-inch Thickness Reinforced Specimen.

9.5-inches Thickness Reinforced Specimen (Small Rebars)

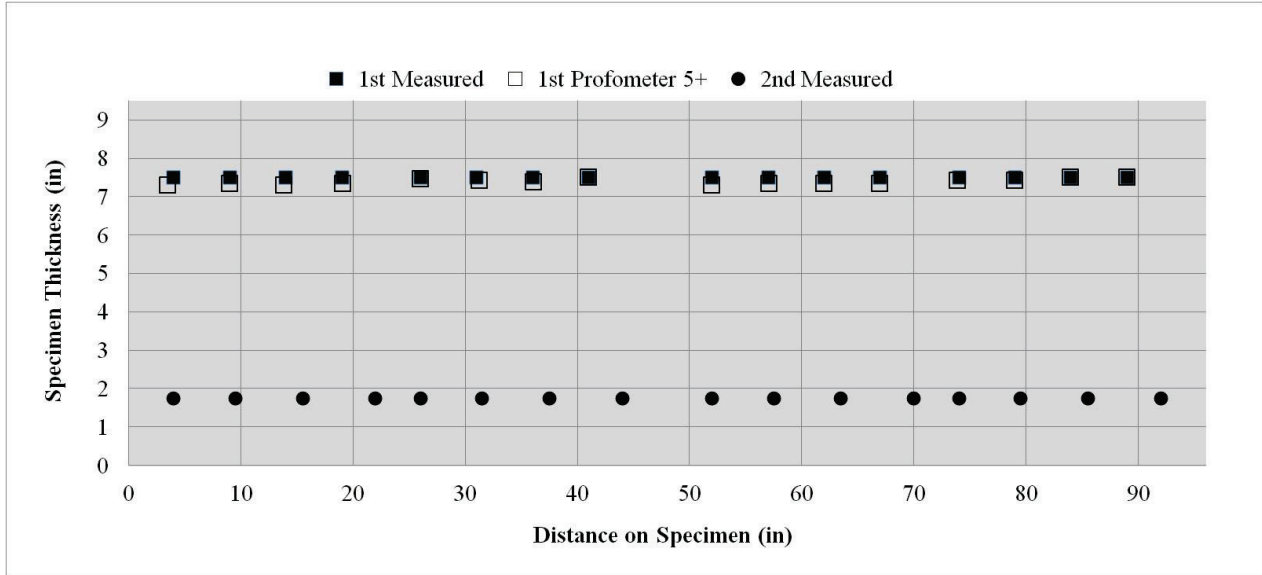

(a) Transverse Rebars

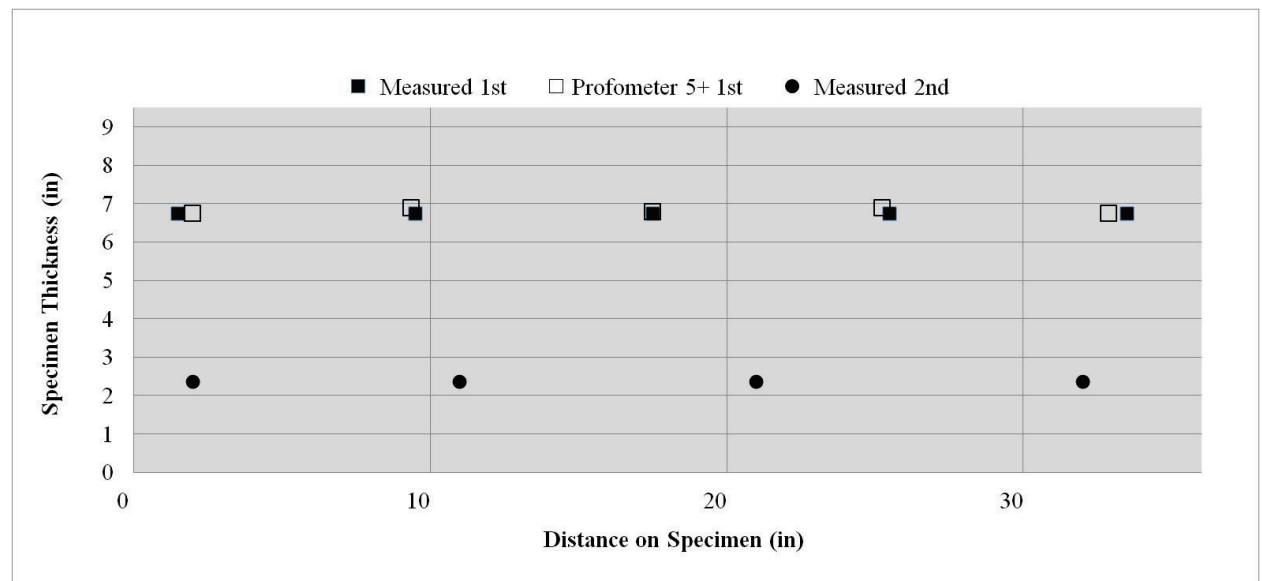

(b) Longitudinal Rebars

Figure 5.93. Proceq (Profometer 5+) Results for 9.5-inch Thickness Reinforced Specimen (Small Rebars).

9.5-inches Thickness Reinforced Specimen (Big Rebars)

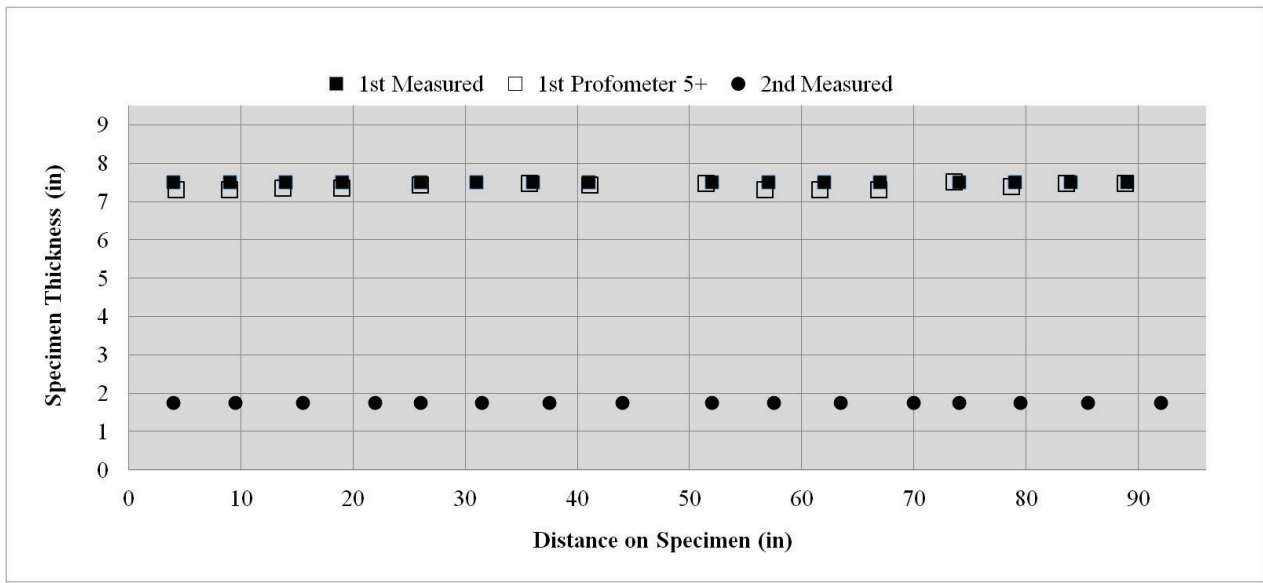

(a) Transverse Rebars

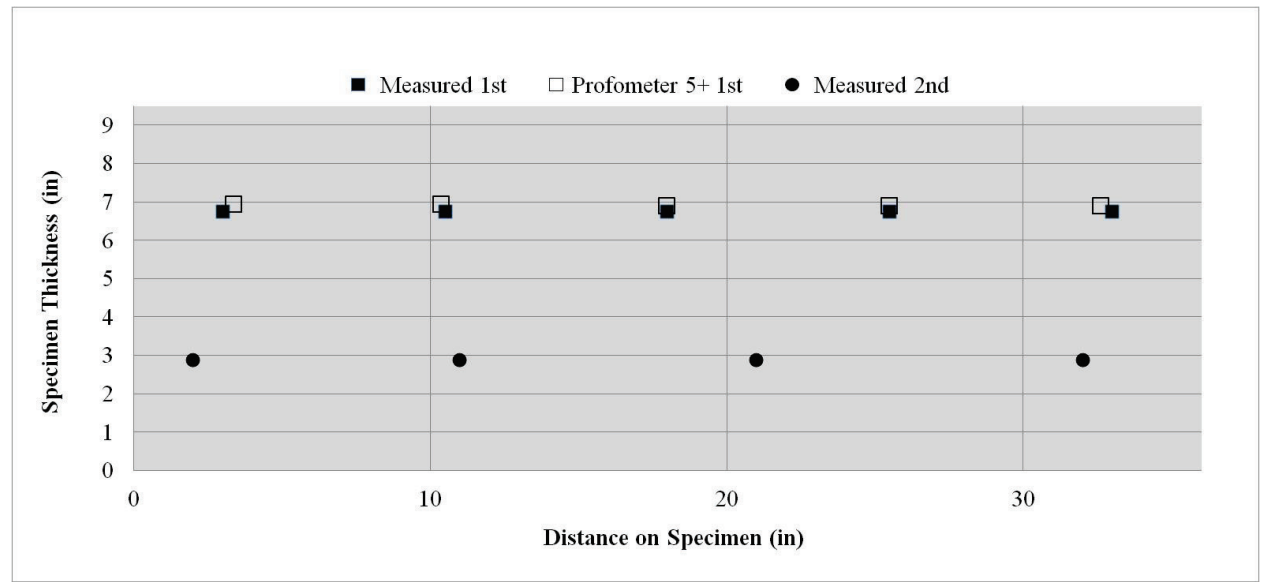

(b) Longitudinal Rebars

Figure 5.94. Proceq (Profometer 5+) Results for 9.5-inch Thickness Reinforced Specimen (Big Rebars).

Hilti (Ferroskan PS200)

Details on the characteristics and use of the Hilti Ferroskan device are reported in Appendix F. Following, the data obtained from scanning of the reinforced concrete specimens with Hilti Ferroskan PS200 covermeter device are reported (Figures 5.95 to 5.98).

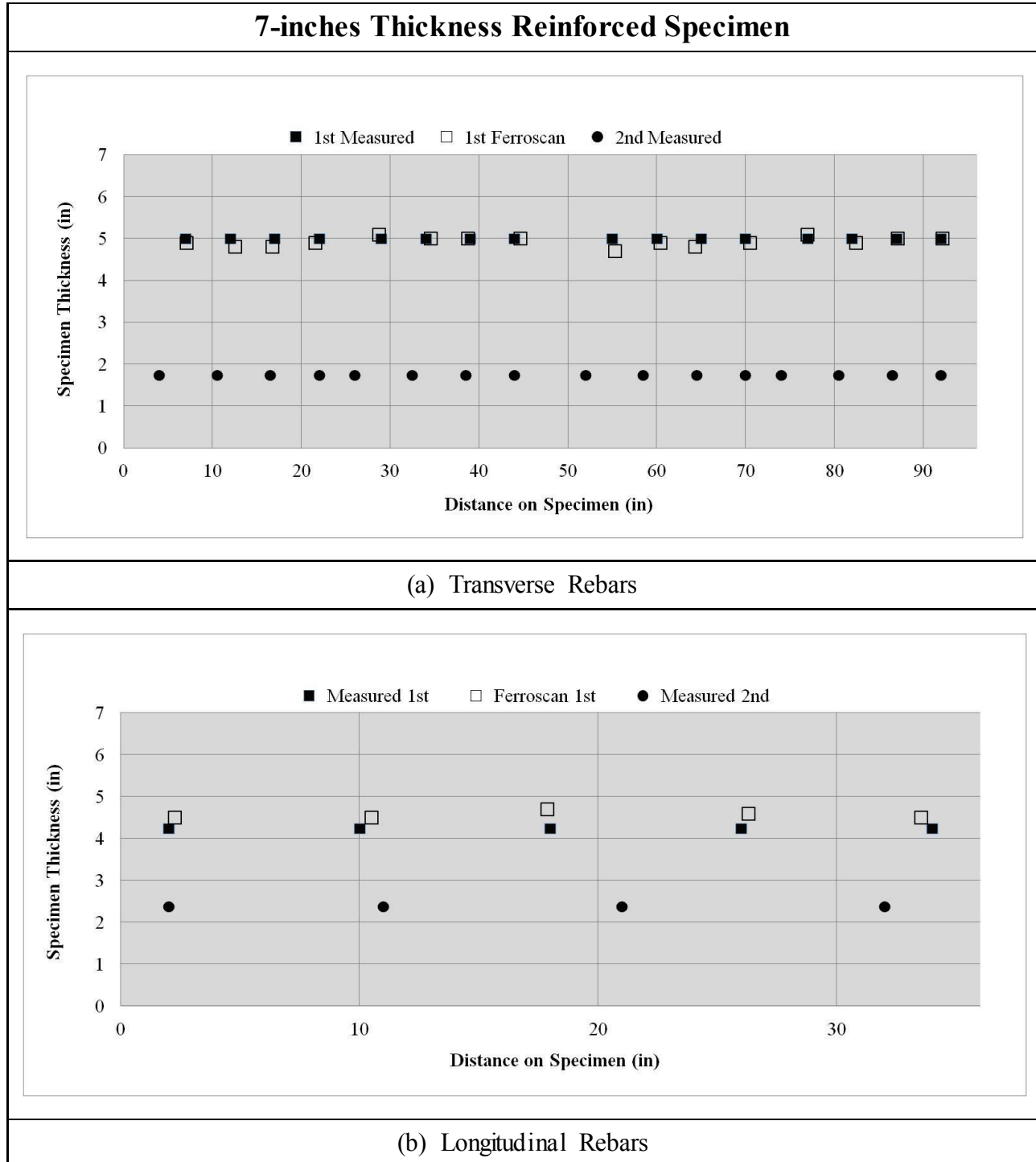
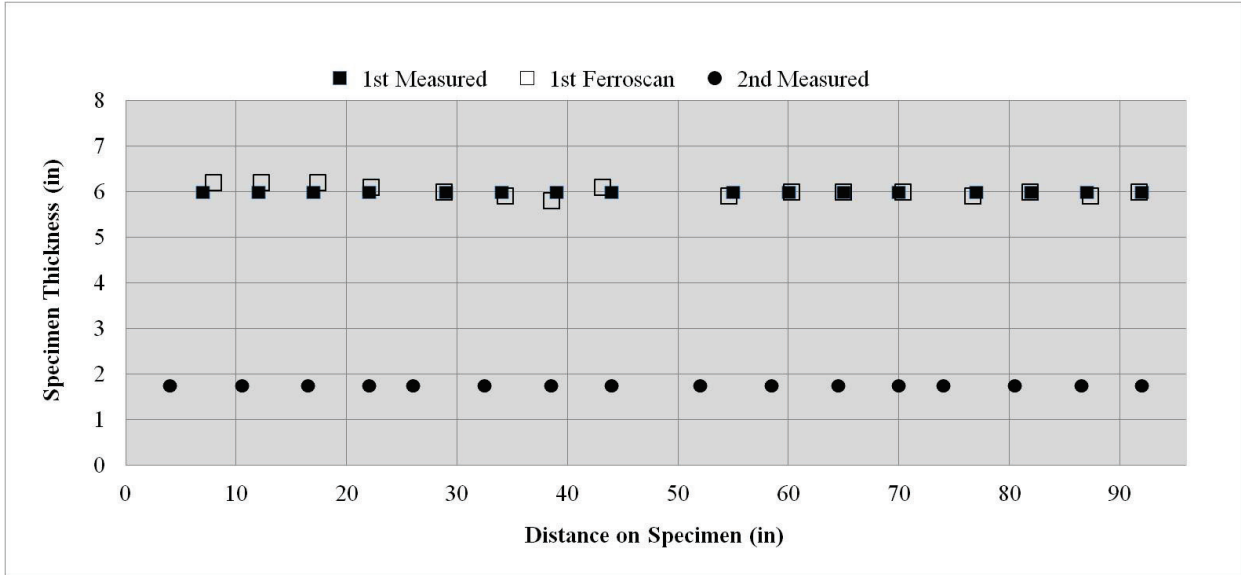
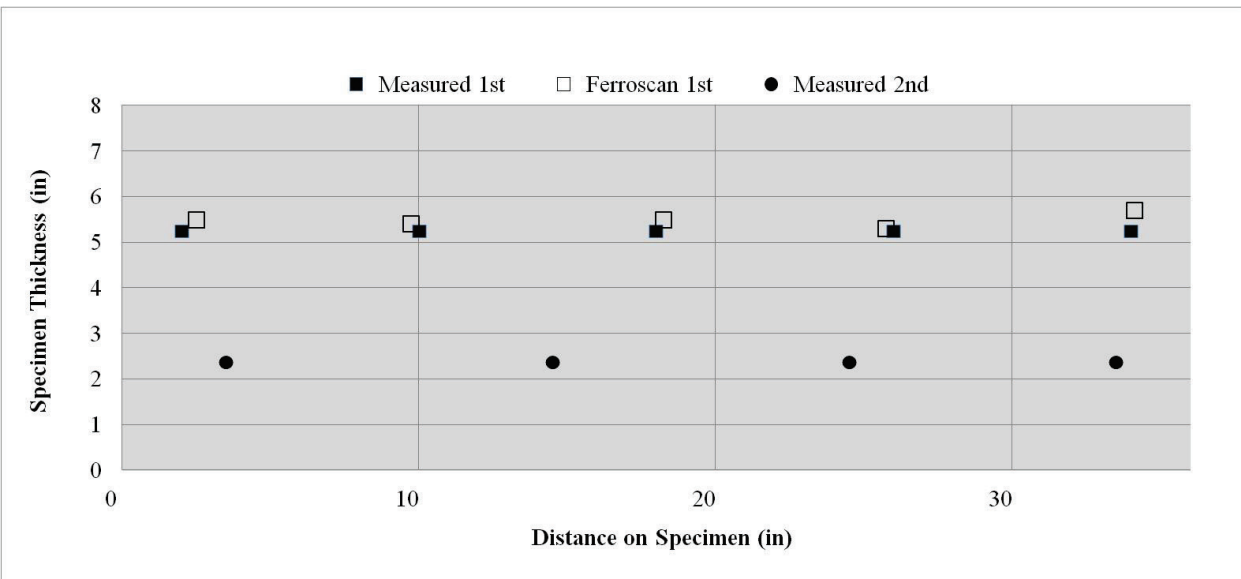

Figure 5.95. Hilti (Ferroskan) Results for 7-inch Thickness Reinforced Specimen.

8-inches Thickness Reinforced Specimen



(a) Transverse Rebars



(b) Longitudinal Rebars

Figure 5.96. Hilti (Ferroskan) Results for 8-inch Thickness Reinforced Specimen.

9.5-inches Thickness Reinforced Specimen (Small Rebars)

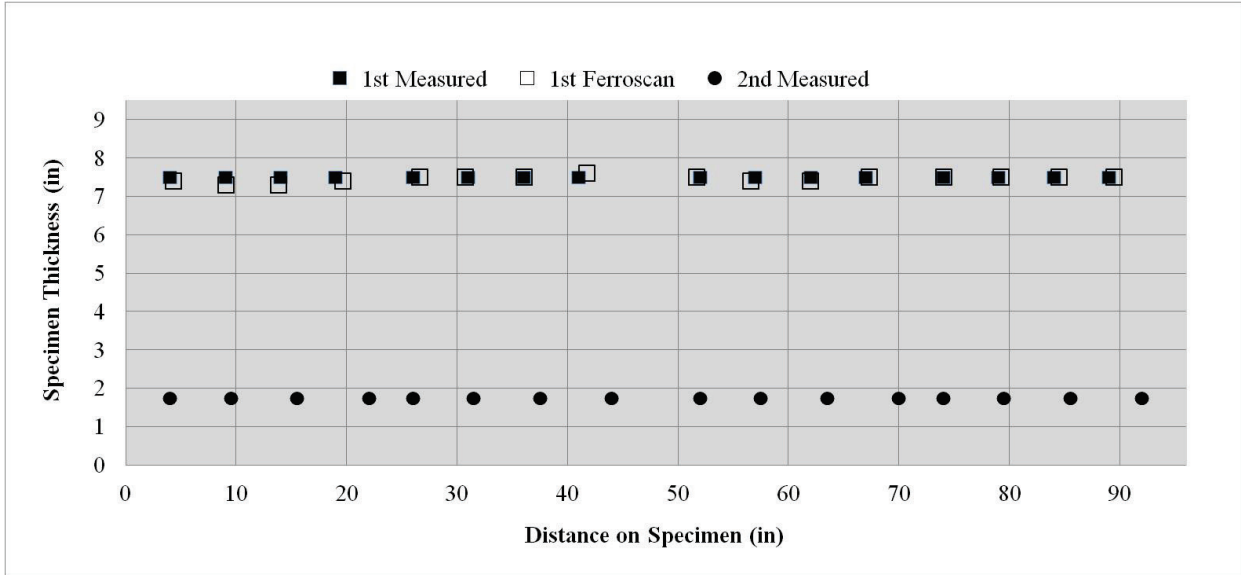

(a) Transverse Rebars

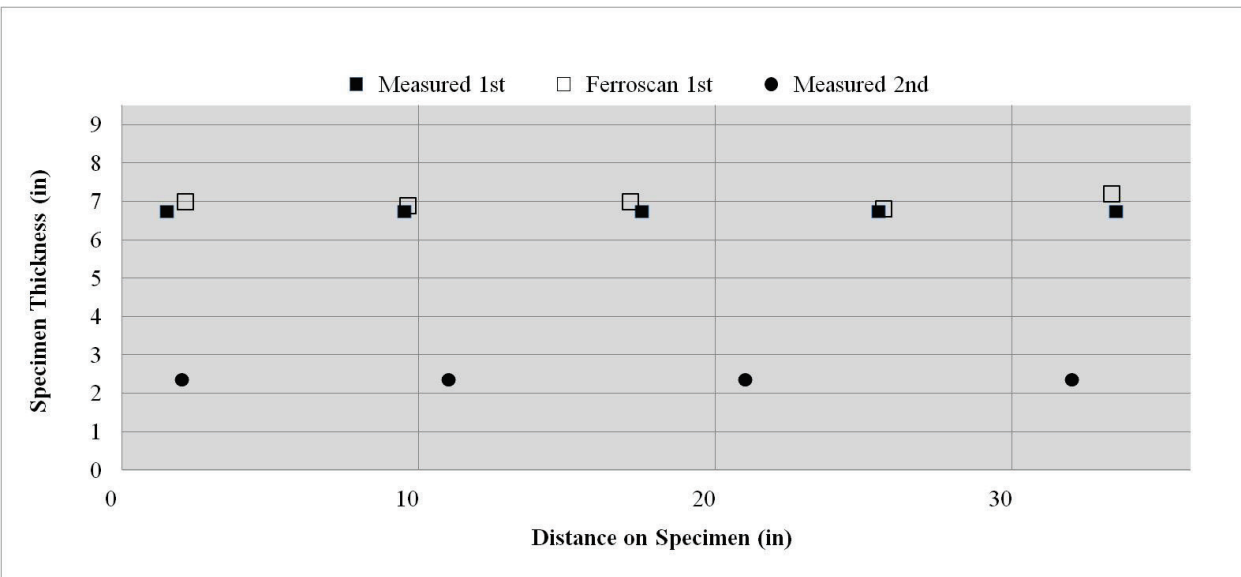

(b) Longitudinal Rebars

Figure 5.97. Hilti (Ferroscan) Results for 9.5-inch Thickness Reinforced Specimen (Small Rebars).

9.5-inches Thickness Reinforced Specimen (Big Rebars)

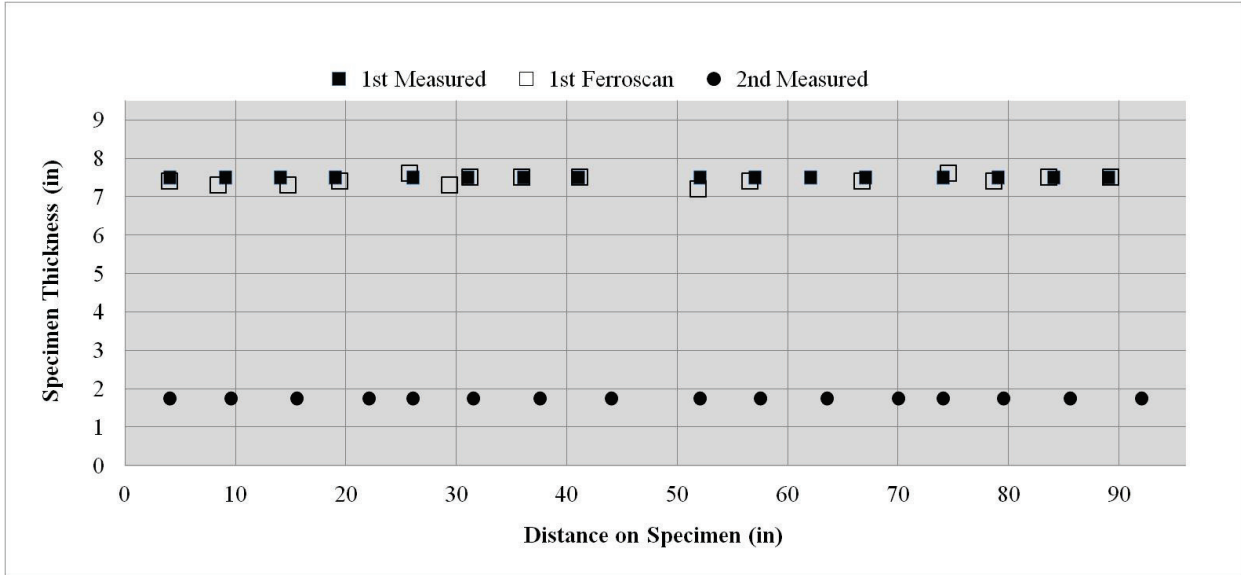

(a) Transverse Rebars

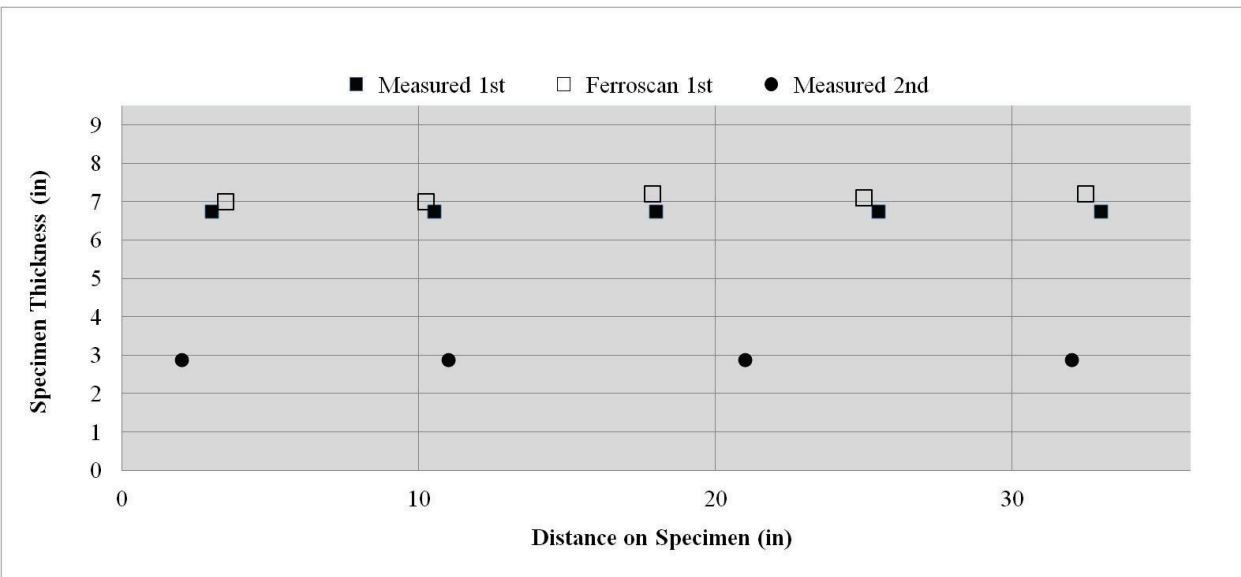

(b) Longitudinal Rebars

Figure 5.98. Hilti (Ferroskan) Results for 9.5-inch Thickness Reinforced Specimen (Big Rebars).

CHAPTER 6. SUMMARY

GPR DEVICES

On-Site Rebars Detection

Following, on-site data obtained from scanning of the reinforced concrete specimens with GPR devices are summarized and compared (Figures 6.1 to 6.7).

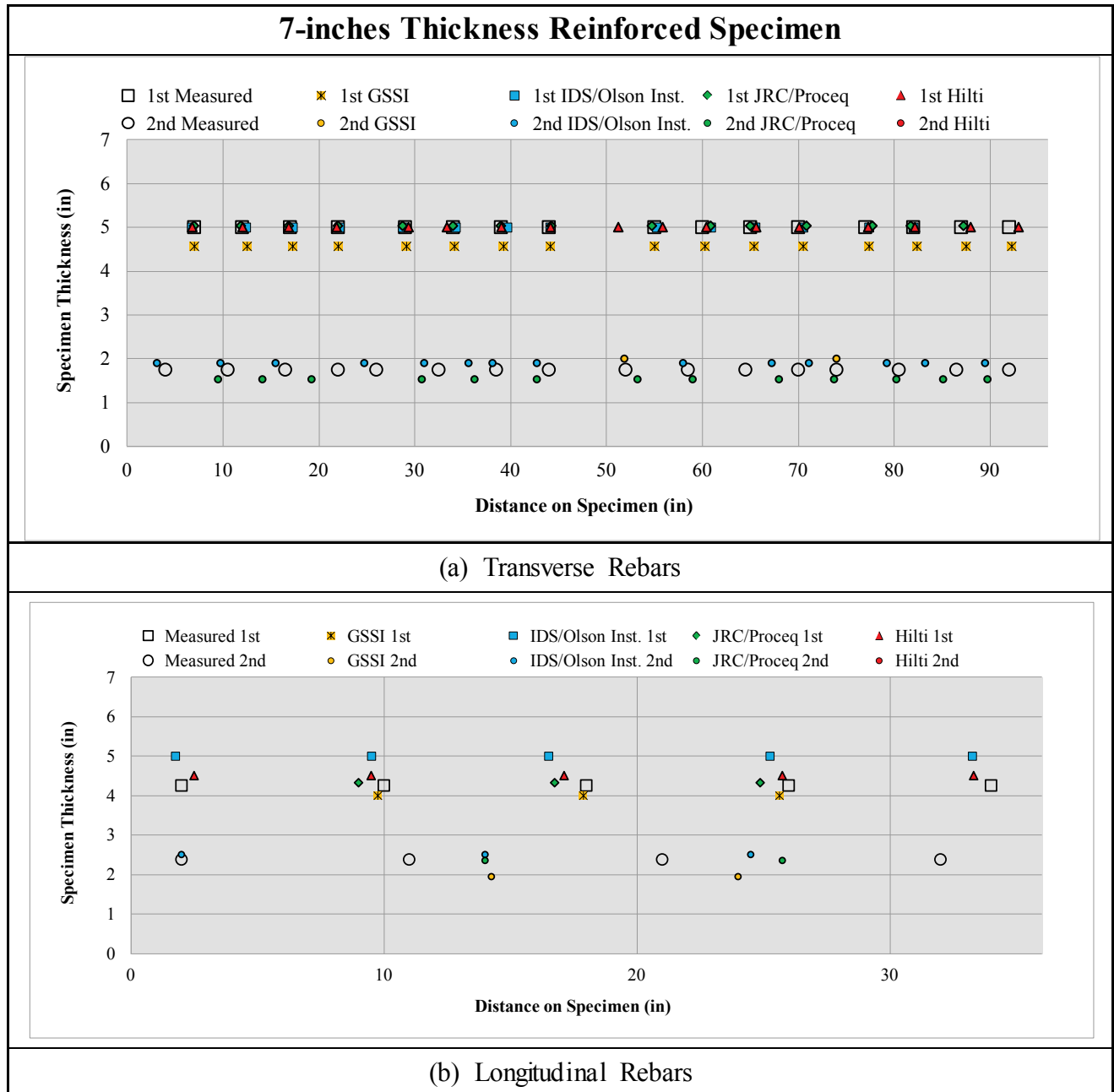
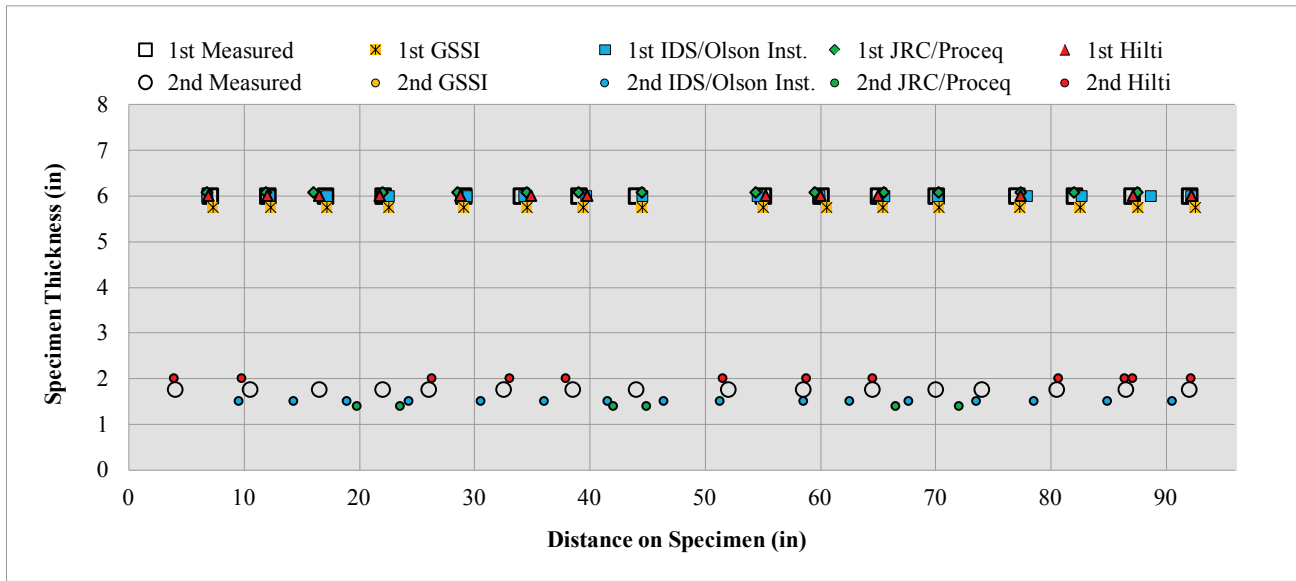
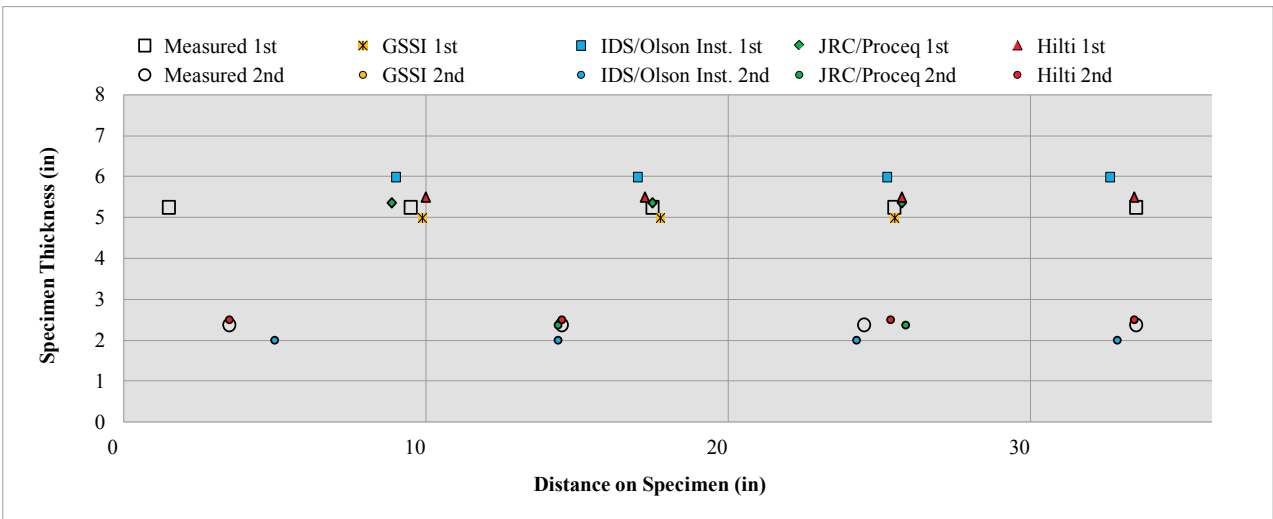

Figure 6.1. On-Site Results for 7-inch Thickness Reinforced Specimen - SUMMARY.

8-inches Thickness Reinforced Specimen



(a) Transverse Rebars



(b) Longitudinal Rebars

Figure 6.2. On-Site Results for 8-inch Thickness Reinforced Specimen - SUMMARY.

8-inches Thickness Reinforced Specimen Elevated

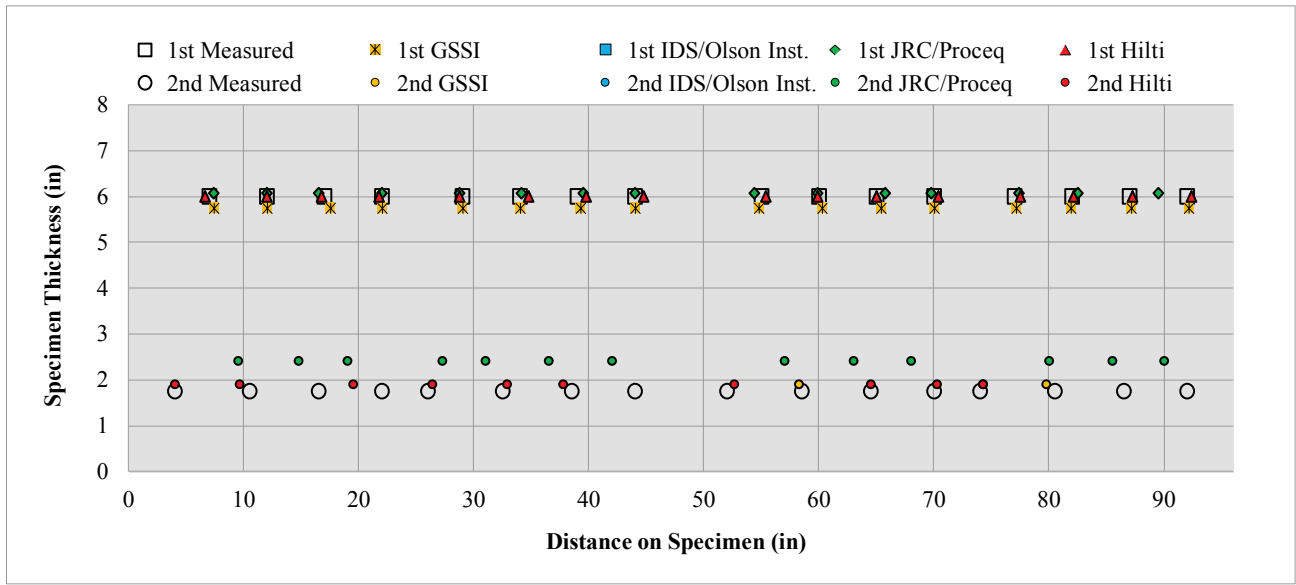

(a) Transverse Rebars

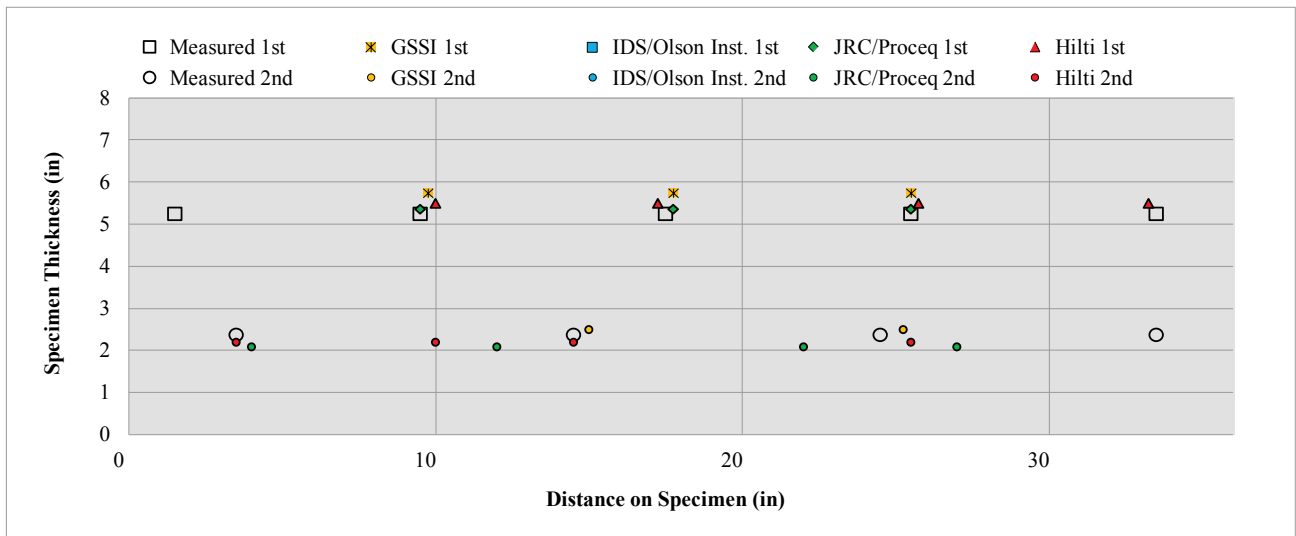

(b) Longitudinal Rebars

*Due to time constraints, Olson Engineering did not perform an on-site 2D scanning of this block. Results are anyway reported for comparison of the other GPR devices employed.

Figure 6.3. On-Site Results for 8-inch Thickness Reinforced Specimen Elevated - SUMMARY.

9.5-inches Thickness Reinforced Specimen (Small Rebars)

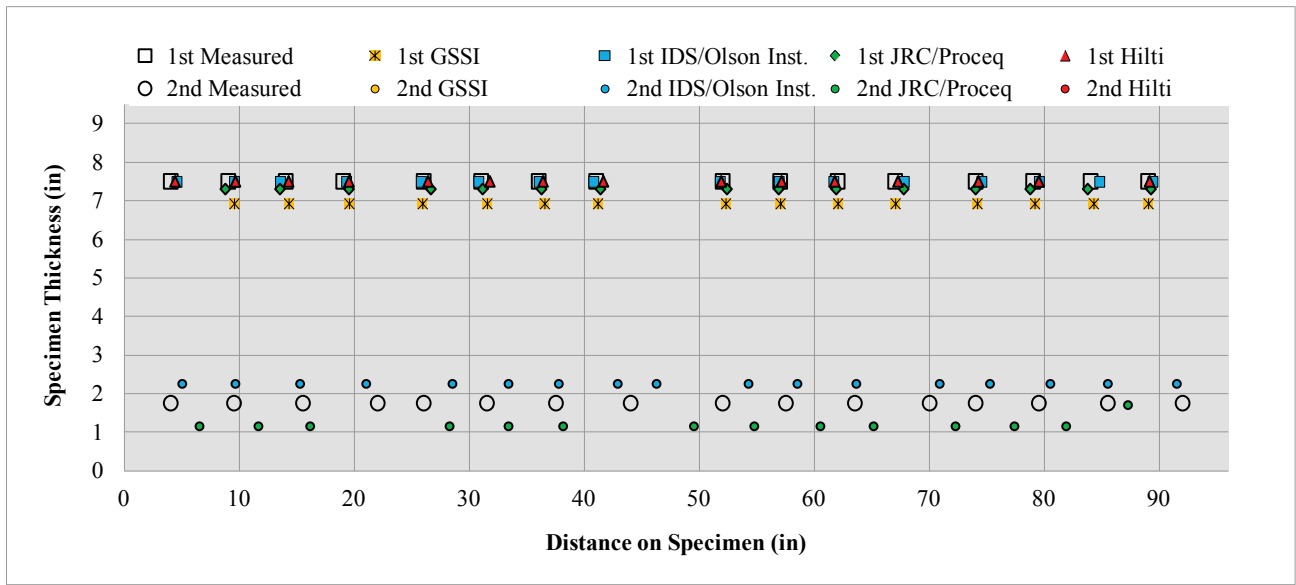

(a) Transverse Rebars

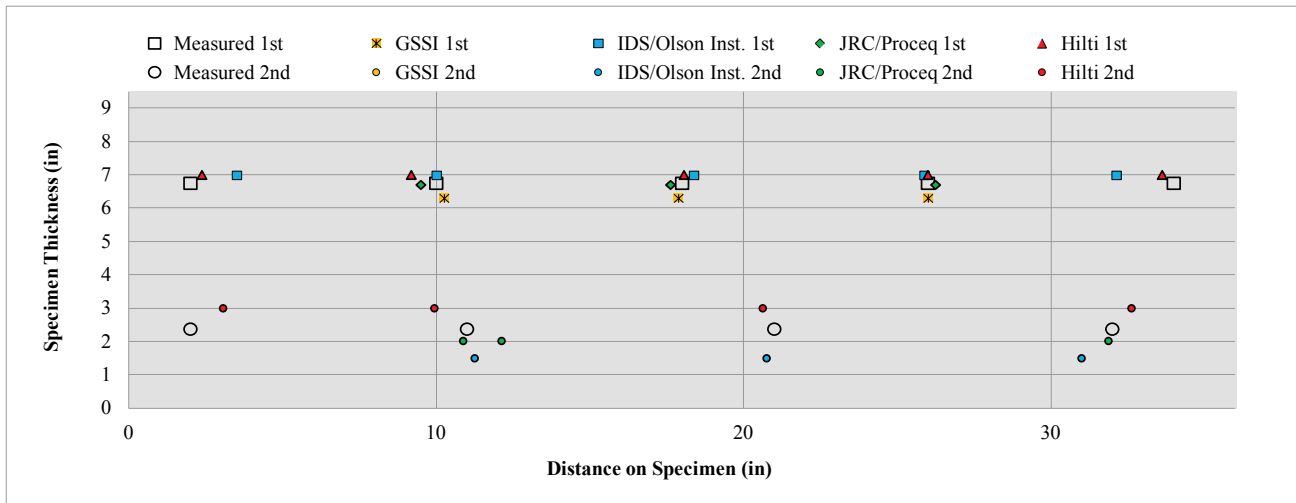

(b) Longitudinal Rebars

Figure 6.4. On-Site Results for 9.5-inch Thickness Reinforced Specimen (Small Rebars) - SUMMARY.

9.5-inches Thickness Reinforced Specimen (Big Rebars)

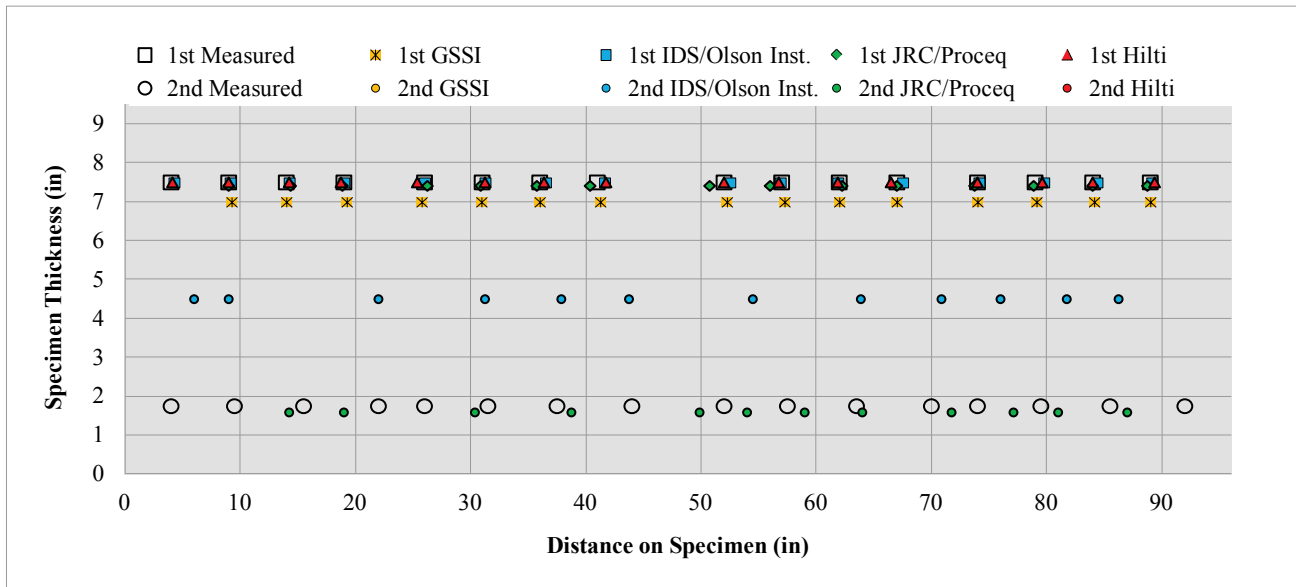

(a) Transverse Rebars

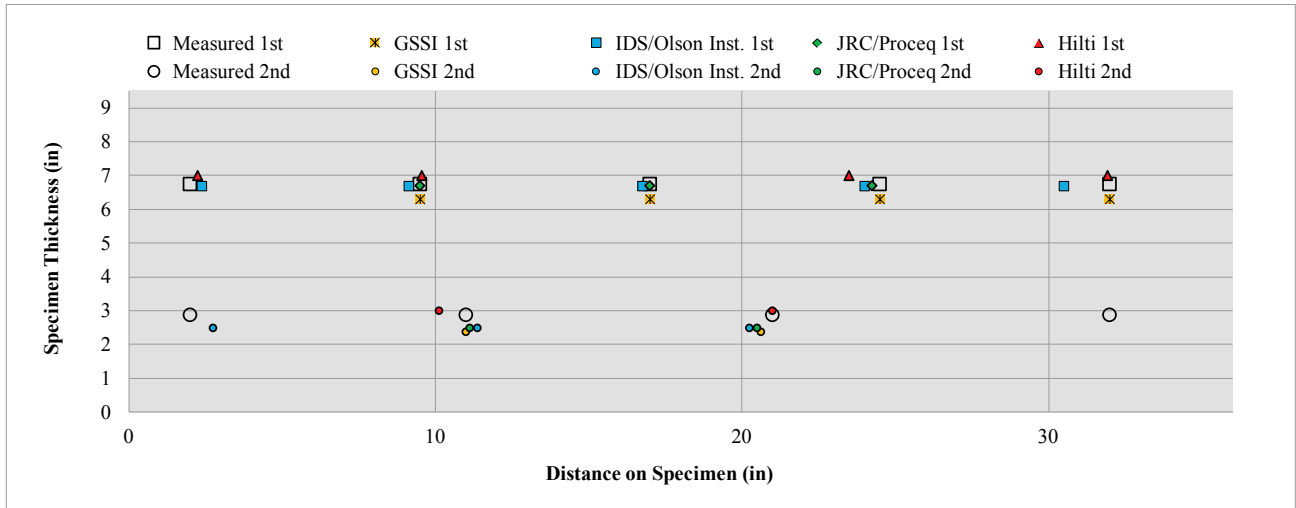

(b) Longitudinal Rebars

Figure 6.5. On-Site Results for 9.5-inch Thickness Reinforced Specimen (Big Rebars) - SUMMARY.

10-inches Thickness Reinforced Specimen

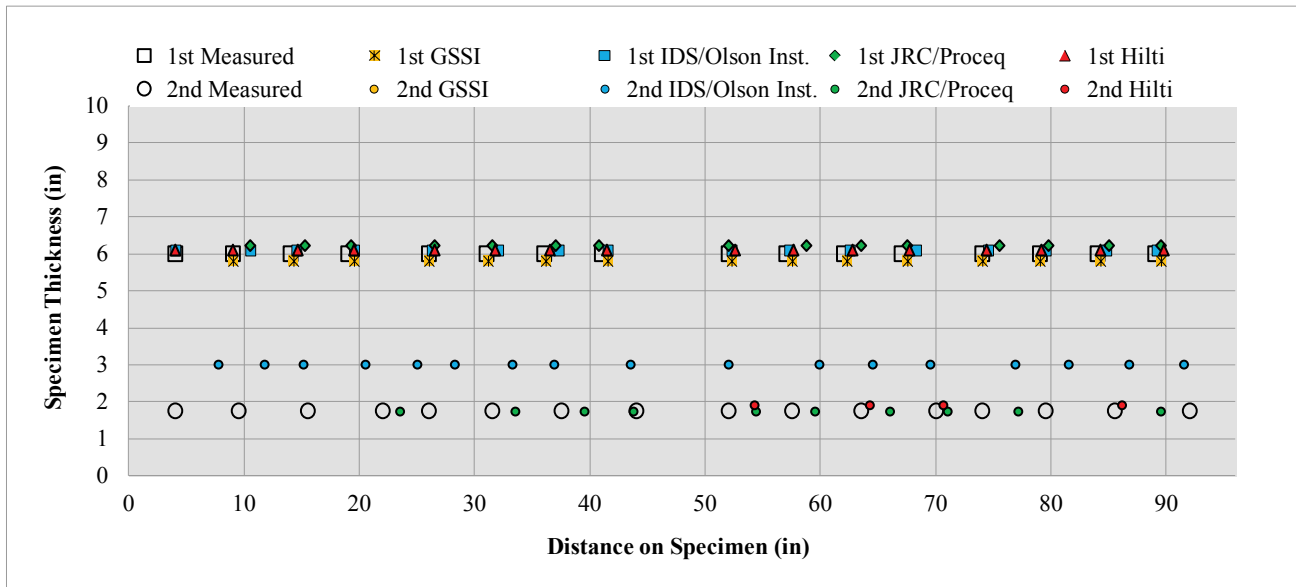

(a) Transverse Rebars

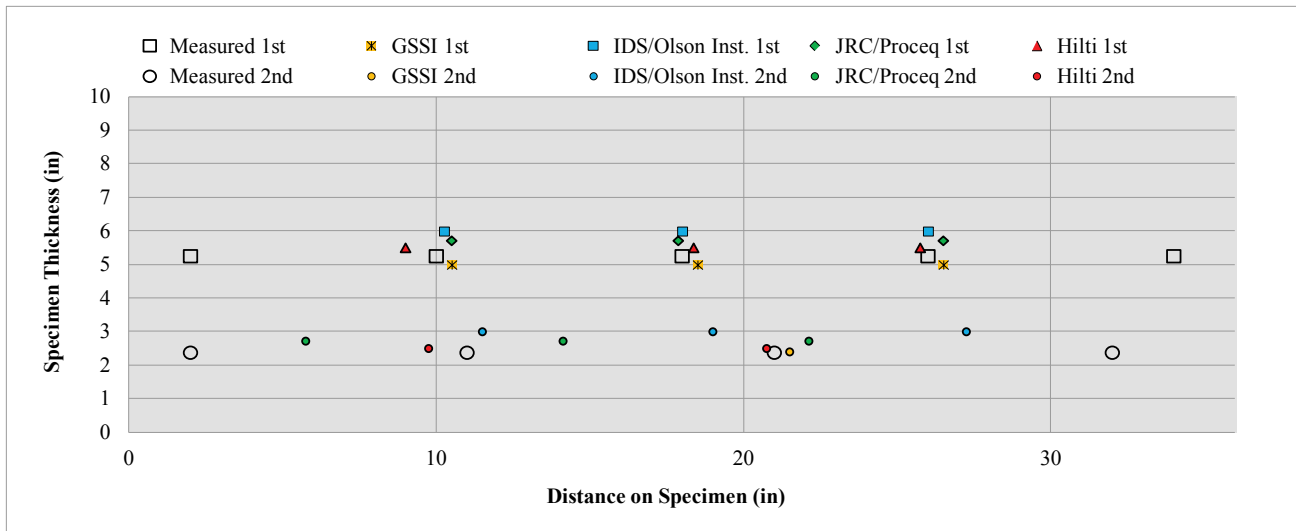

(b) Longitudinal Rebars

Figure 6.6. On-Site Results for 10-inch Thickness Reinforced Specimen - SUMMARY.

10-inches Thickness Reinforced Specimen Elevated

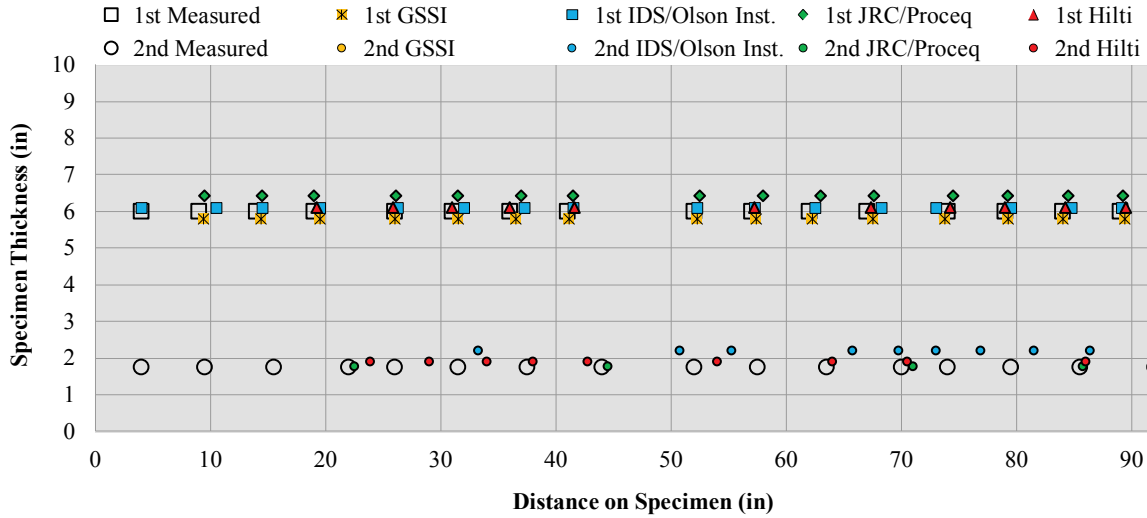

(a) Transverse Rebars

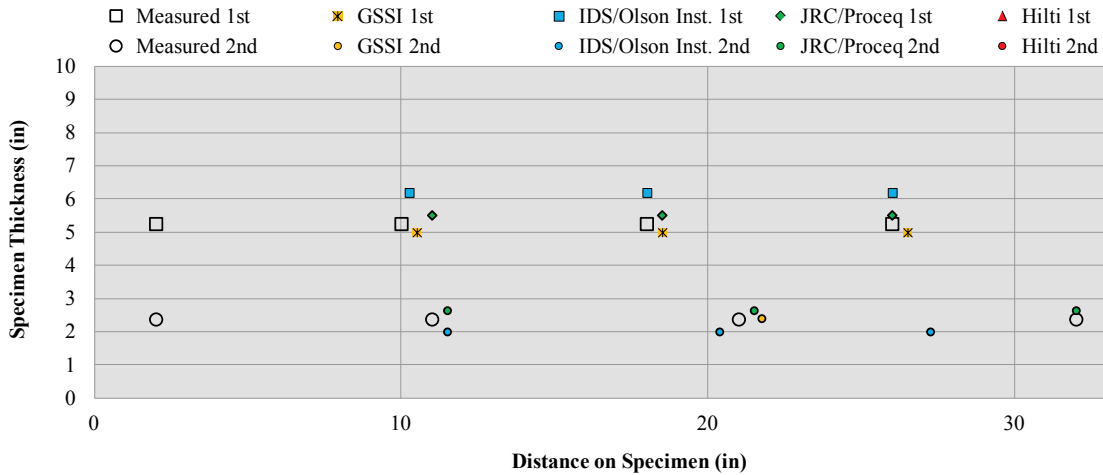

(b) Longitudinal Rebars

Figure 6.7. On-Site Results for 10-inch Thickness Reinforced Specimen Elevated - SUMMARY.

Comments

The GPR devices were generally able to accurately locate rebars from the top layer, where the concrete coverage varied between 2 and 5 inches, according to the type of rebar considered (transverse or longitudinal) and whether there was a 2-inch asphalt layer on top of the specimen. Concrete coverage of the first layer was also generally accurately detected.

As for the detection of the second layer, more difficulties were encountered. Most of the time, the participating companies preferred not to report the location of the rebars from the second layer on-site, but decided to wait until post-processing the data. When on-site rebar locations were identified through the GPR devices and reported by the companies, results were not always within 1-inch location accuracy. One of the most cited difficulties reported by the Companies representatives when interpreting the collected scanned data was not to mistakenly confuse the cross point of upper echo's rebars ends for the echo of a lower rebar. When evaluating the results collected, though, it seemed that sometimes the Companies representatives erroneously detected a not-existing rebar between two existing rebars. This common mistake might be connected to the erroneous confusion of the cross point of two upper echo's rebars ends for the echo of a lower rebar.

Although use of the devices was relatively simple and easy, interpretation of the results showed on the screen required a certain level of training for the user. Top layer rebars were usually easier to identify because of the limited concrete coverage and because of no interference from bottom layer rebars. However, especially for bottom layer of reinforcement, identification of rebars required more complex evaluation of the data, which required certain engineering knowledge. In those cases, use of post-processing programs would help for a more accurate identification of the second layer rebar locations and concrete coverage.

Frequently, devices were not capable of detecting rebars that were located closer to the edges of the specimens. In those cases, Companies alluded to an "edge effect", referring to probable interference by the end of the specimen on the device detecting capabilities. This type of interference, however, should not be a big concern for roadside safety applications of the GPR devices, such as their use to identify rebar locations on bridge decks or concrete paved roads, since rarely the user will have to deal with the edge of the reinforced concrete.

The rebar locator capability of the GPR devices did not appear to be influenced by scanning the reinforced concrete specimens when they were elevated from the ground. In fact, results from scanning the same specimen when laying on the ground and when elevated from the ground were very similar.

Post-Processed Rebars Detection

Following, on-site data obtained from scanning of the reinforced concrete specimens with GPR devices are summarized and compared (Figures 6.8 to 6.14).

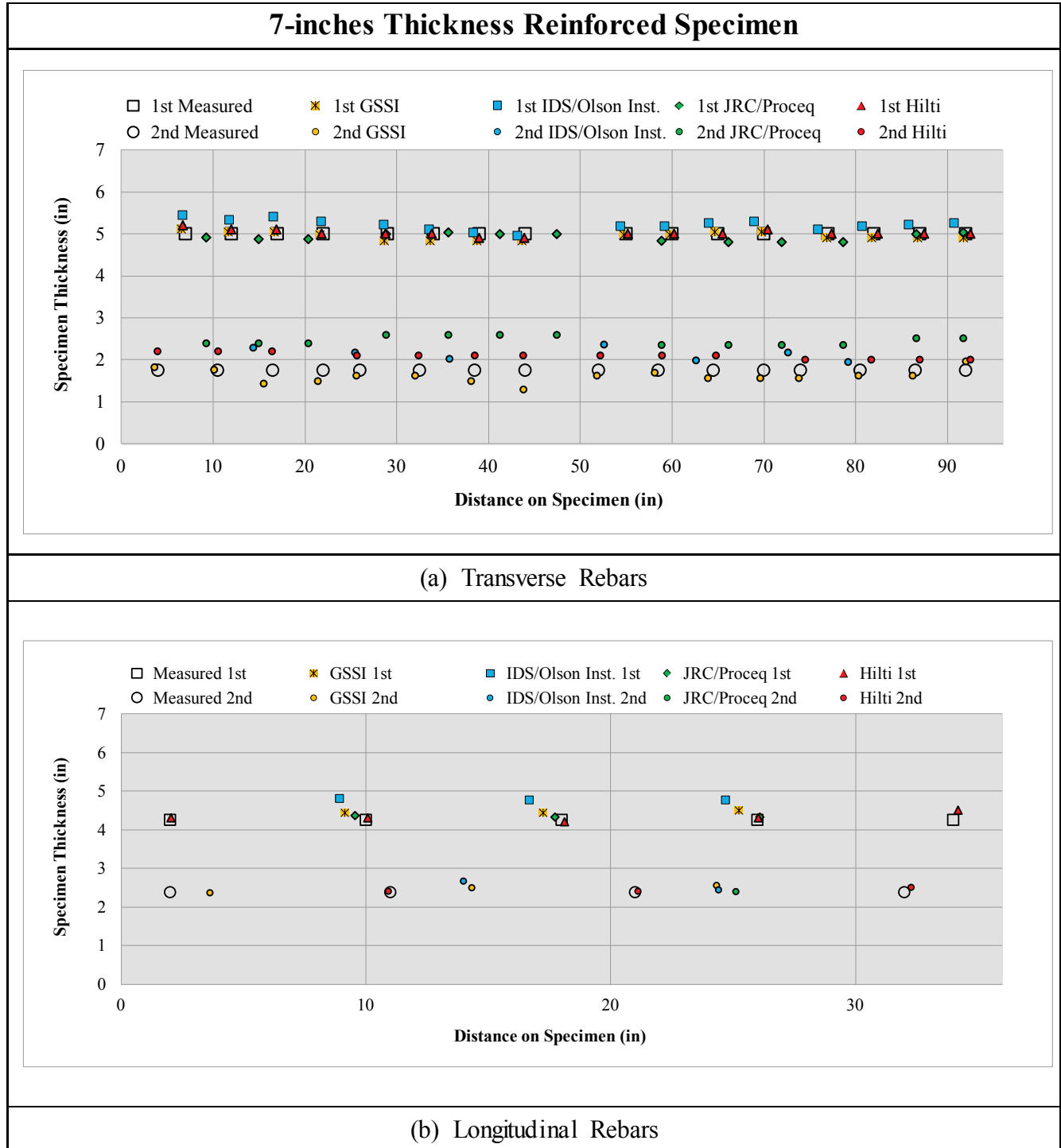
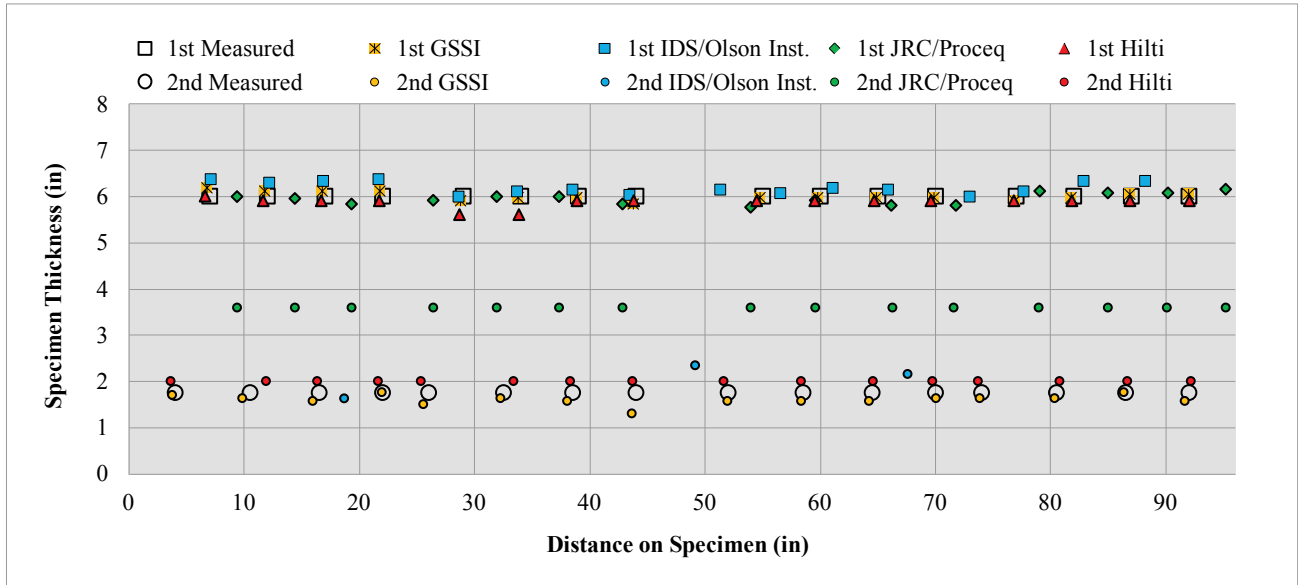
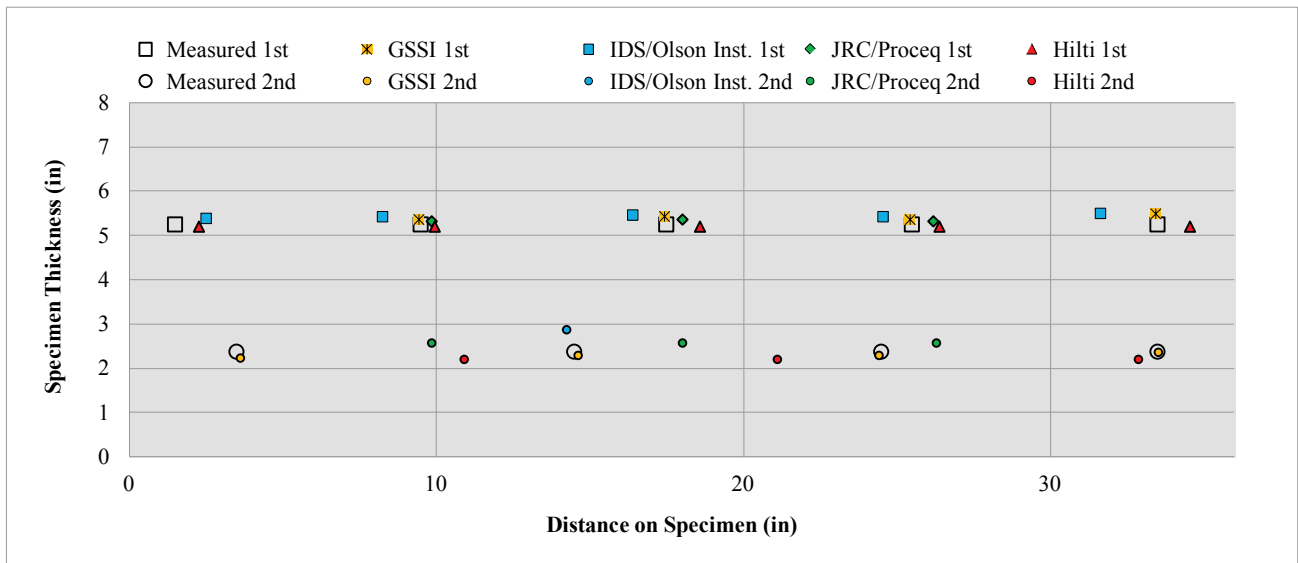

Figure 6.8. Post-Processed Results for 7-inch Thickness Reinforced Specimen - SUMMARY.

8-inches Thickness Reinforced Specimen



(a) Transverse Rebars



(b) Longitudinal Rebars

Figure 6.9. Post-Processed Results for 8-inch Thickness Reinforced Specimen - SUMMARY.

8-inches Thickness Reinforced Specimen Elevated

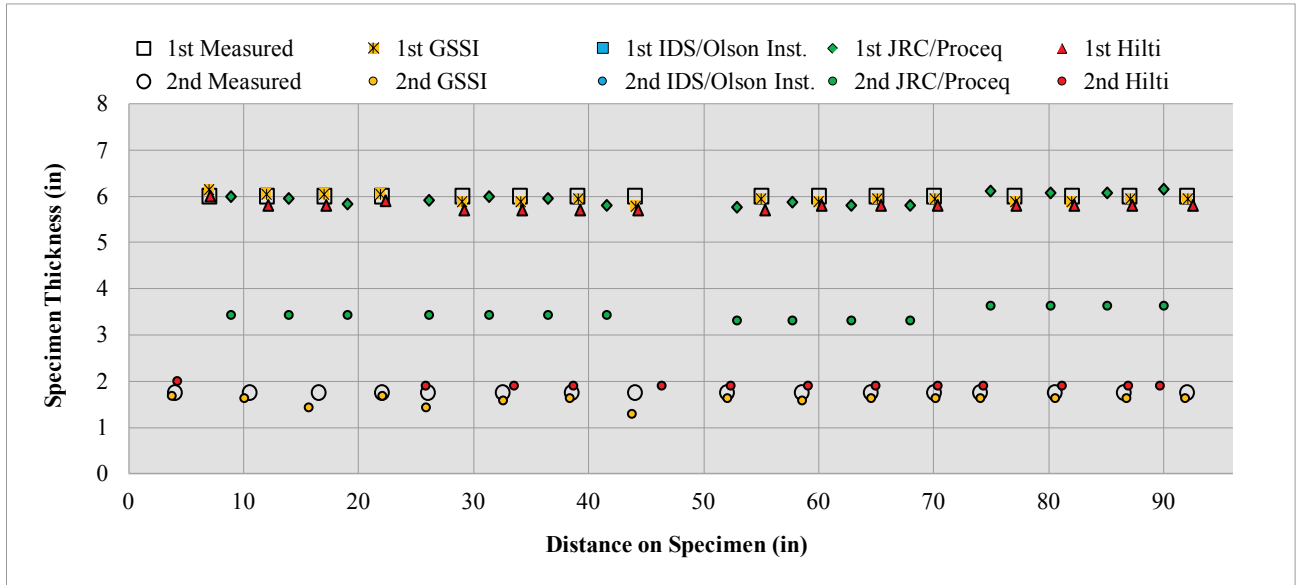

(a) Transverse Rebars

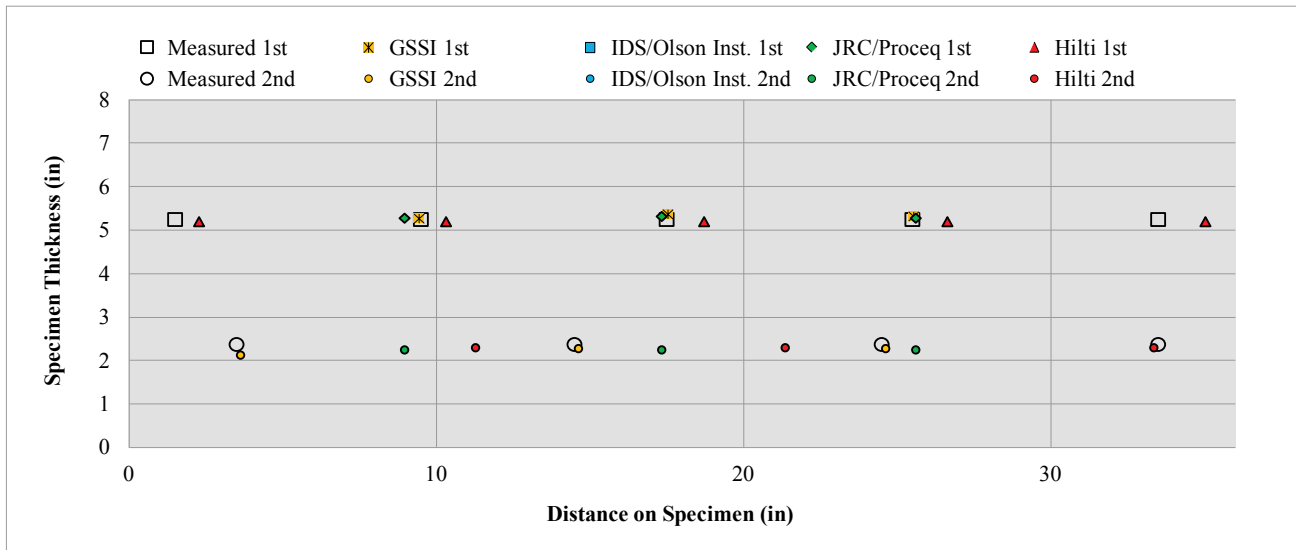

(b) Longitudinal Rebars

Figure 6.10. Post-Processed Results for 8-inch Thickness Reinforced Specimen Elevated - SUMMARY.

9.5-inches Thickness Reinforced Specimen (Small Rebars)

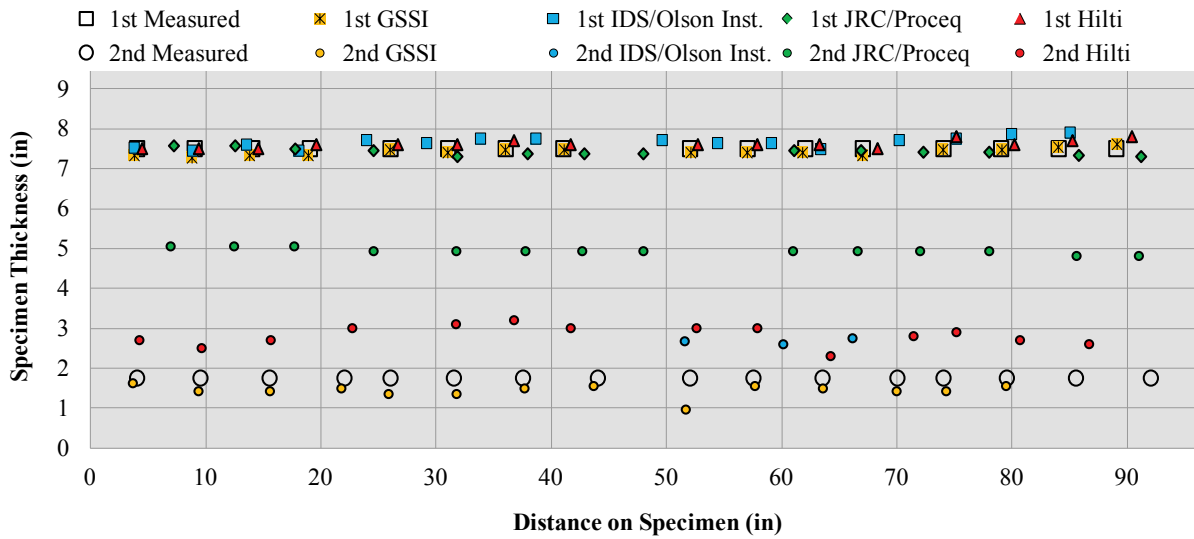

(a) Transverse Rebars

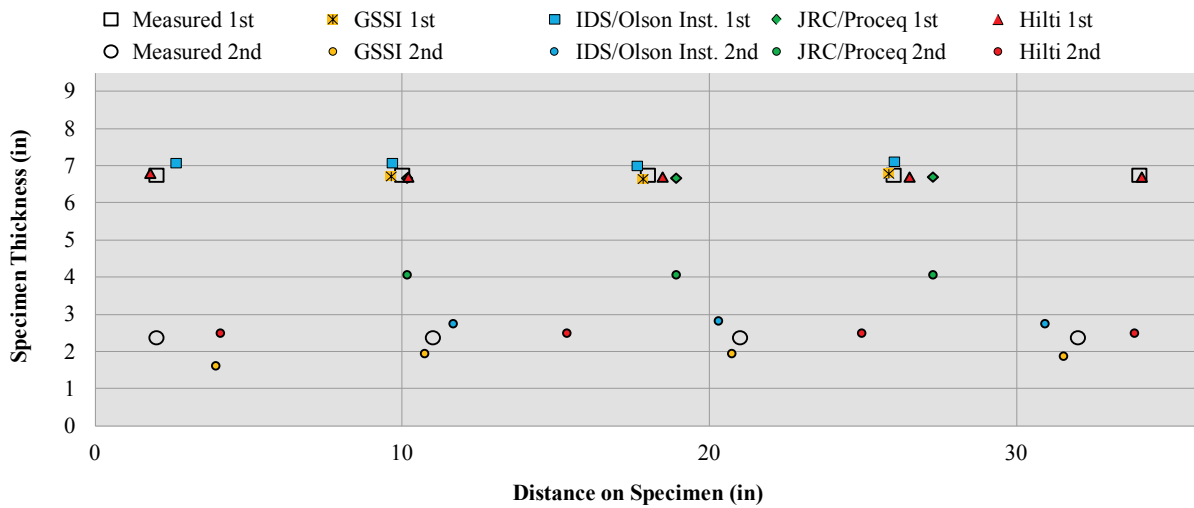

(b) Longitudinal Rebars

Figure 6.11. Post-Processed Results for 9.5-inch Thickness Reinforced Specimen (Small Rebars) - SUMMARY.

9.5-inches Thickness Reinforced Specimen (Big Rebars)

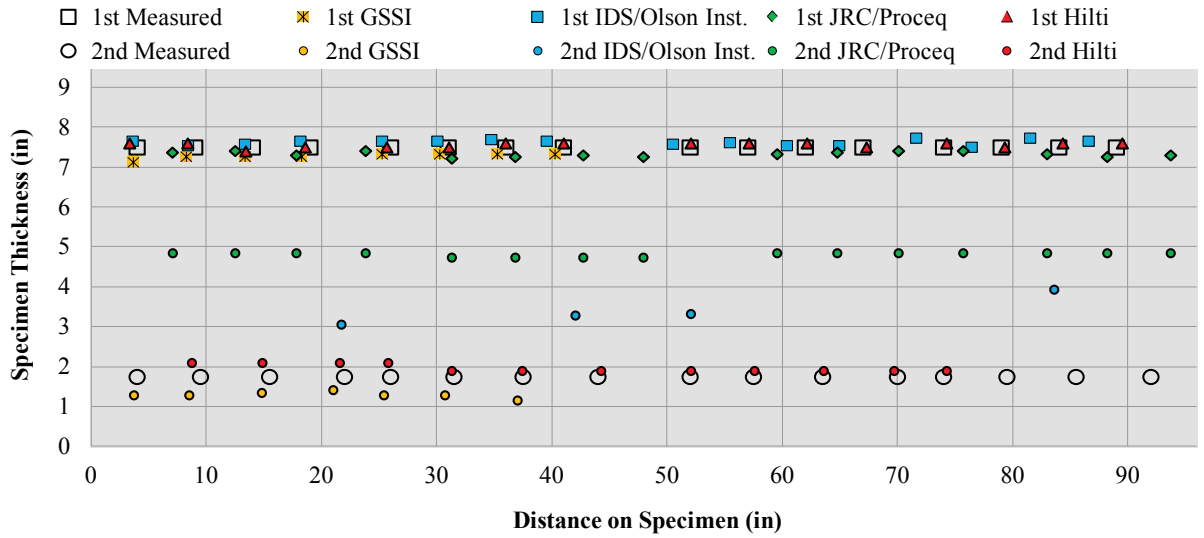

(a) Transverse Rebars

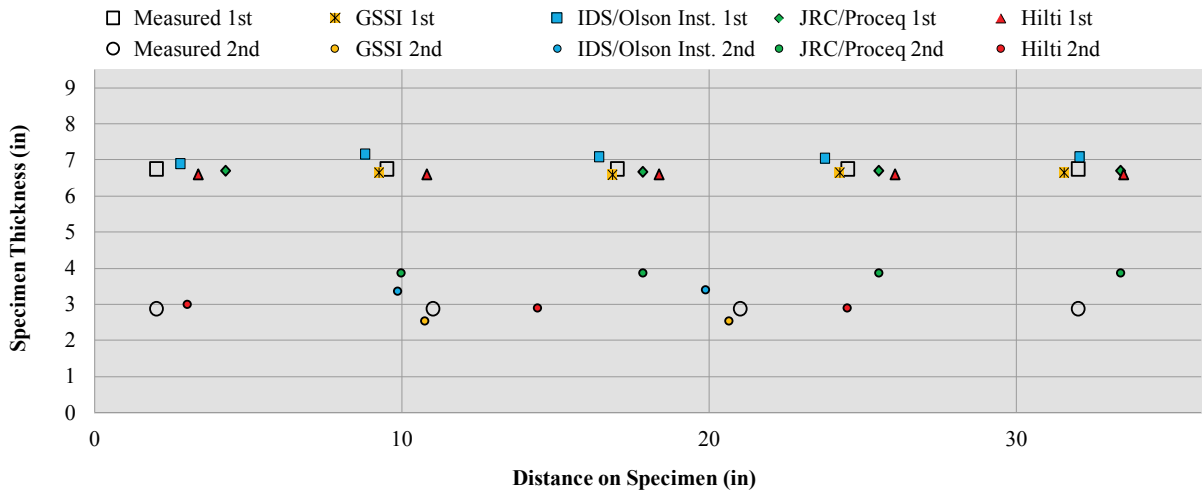

(b) Longitudinal Rebars

Figure 6.12. Post-Processed Results for 9.5-inch Thickness Reinforced Specimen (Big Rebars) - SUMMARY.

10-inches Thickness Reinforced Specimen

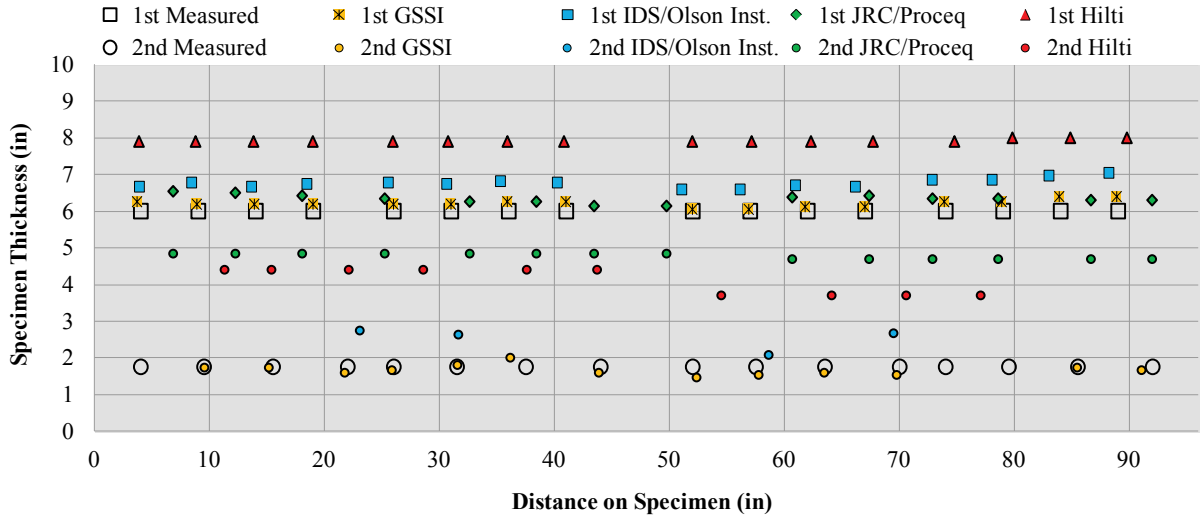

(a) Transverse Rebars

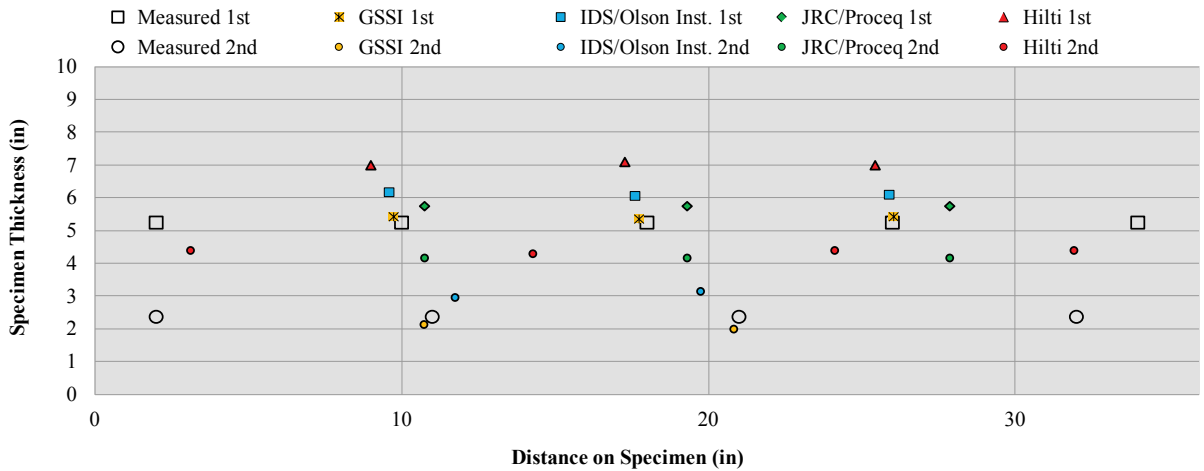

(b) Longitudinal Rebars

Figure 6.13. Post-Processed Results for 10-inch Thickness Reinforced Specimen - SUMMARY.

10-inches Thickness Reinforced Specimen Elevated

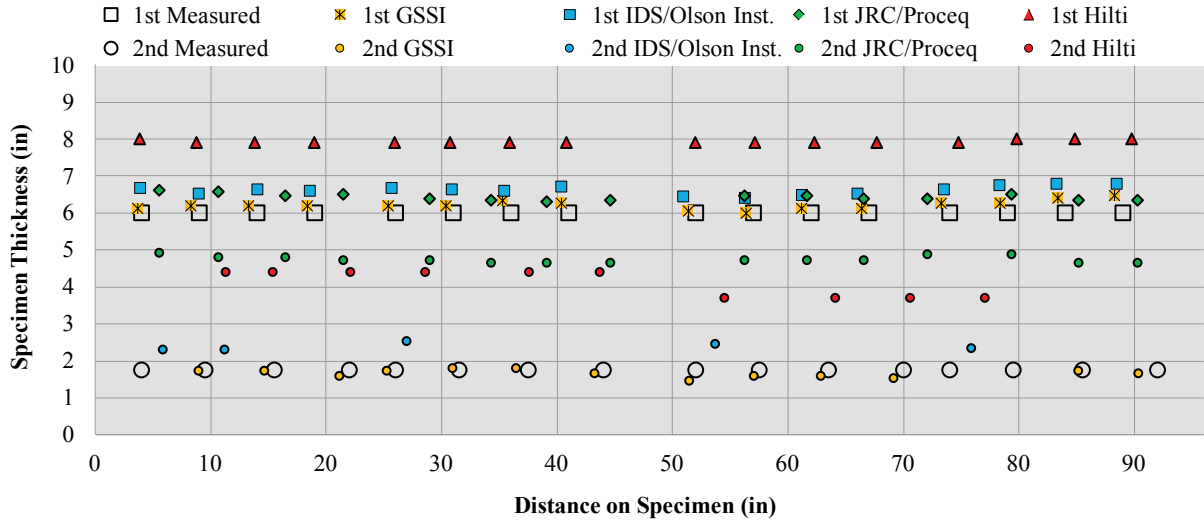

(a) Transverse Rebars

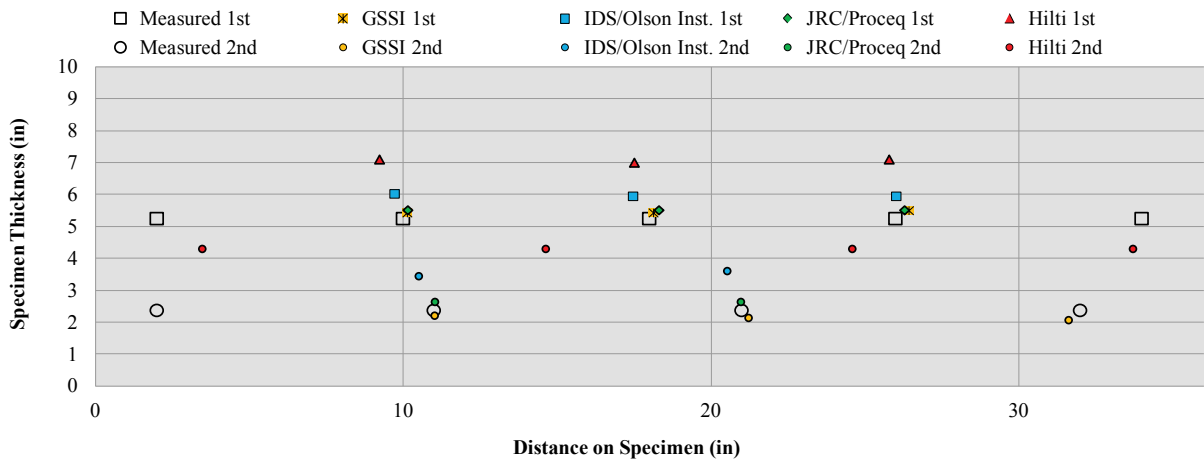

(b) Longitudinal Rebars

Figure 6.14. Post-Processed Results for 10-inch Thickness Reinforced Specimen Elevated - SUMMARY.

Comments

Post-processing the data obtained through the scanning of the reinforced concrete specimens did not have, generally, a big influence on the results when predicting the top layer rebars location. In those cases, detection of the steel bars was fairly congruent with the recorded on-site data. It can be noted, however, that an exception is represented by the post-processed data from the scanning of the 10-inch (both on ground and elevated) reinforced specimen. In this case, surprisingly, post-processed data reported by three out of four companies did not replicate the accuracy of the data recorded on-site, both in term of rebar localization and concrete coverage. Considering the good on-site results reported by each of these companies as for detection of the first layer, however, researchers are linking the less accurate post-processed predictions to some sort of misinterpretations of the data during the post-processed phase.

As for detection of rebar location and concrete coverage of the bottom layer, post-processing the data generally allowed for the location of rebars that were not indicated by scanning of the specimens on-site. Some post-processed data resulted in rebar locations that were consistently shifted from the real position of the bars. This erroneous locations identification might have to be related to the device starting position reported in the file, which might not have always been the same for each specimen testing. TTI researchers noted, however, that in some cases, rebar locations and/or their concrete coverage were not correctly or accurately detected by the GPR technique, even with the help of post-processing programs.

COVERMETER DEVICES

Following, data obtained from scanning of the reinforced concrete specimens with Covermeter devices are summarized and compared (Figures 6.15 to 6.18).

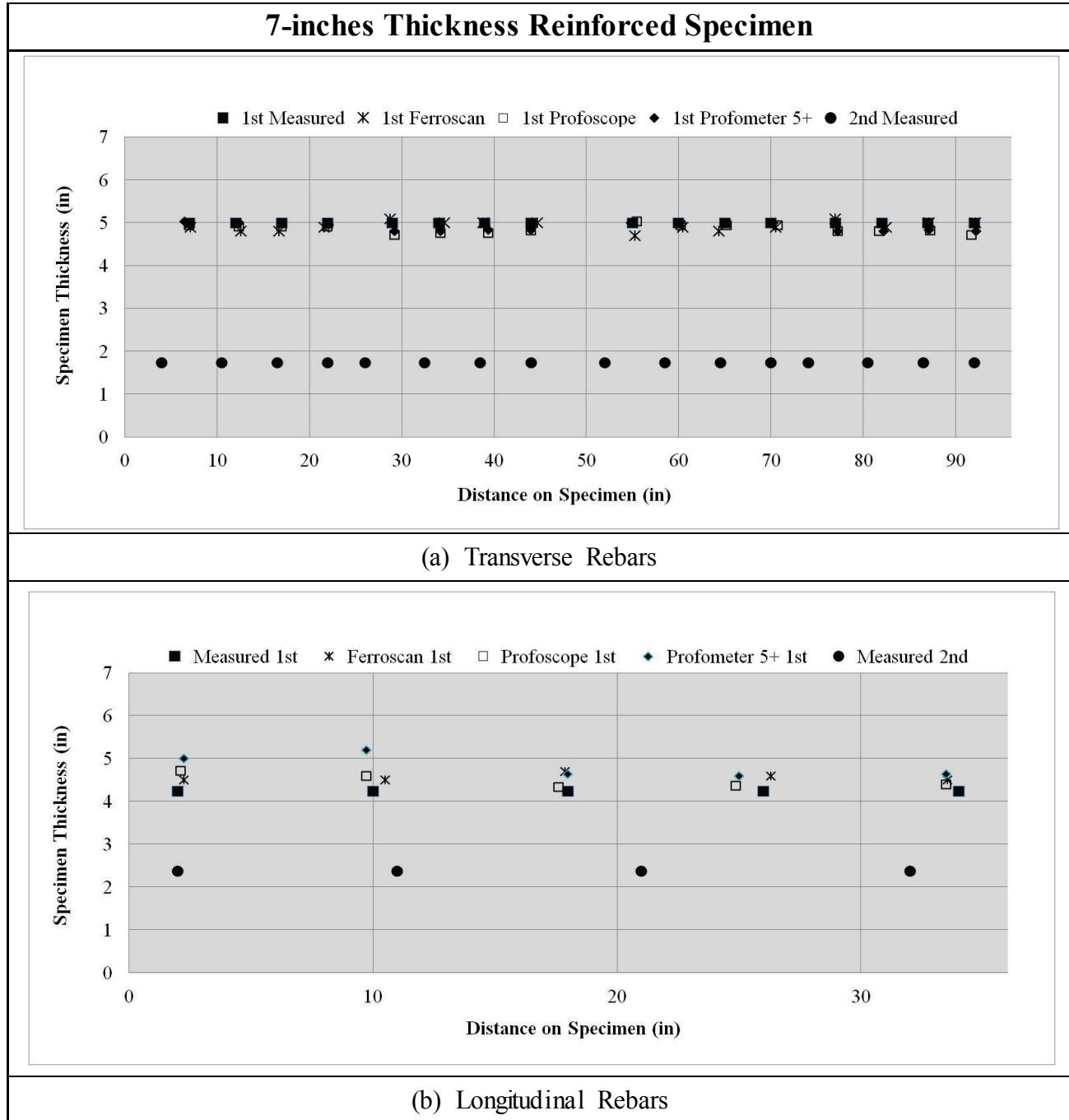
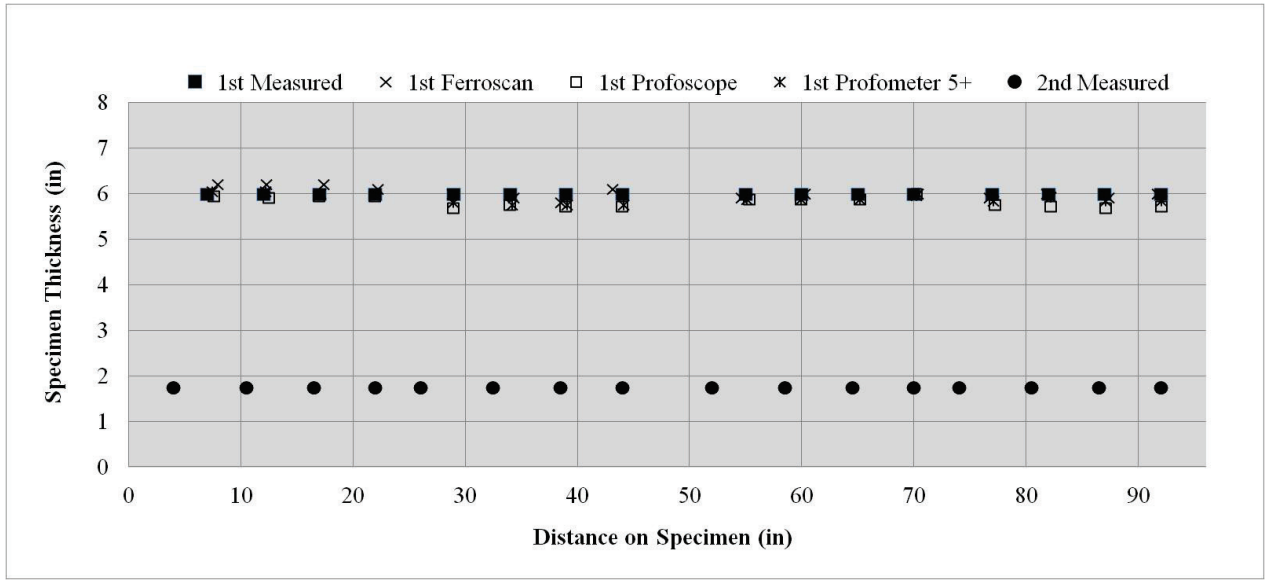
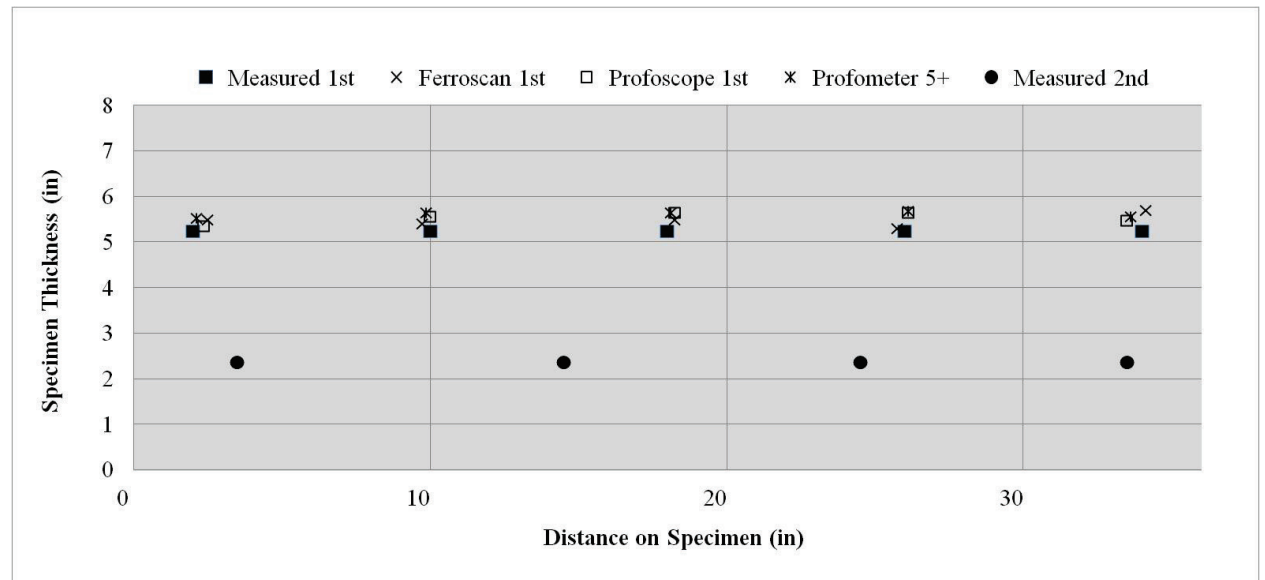

Figure 6.15. Covermeters Results for 7-inch Thickness Reinforced Specimen - Summary.

8-inches Thickness Reinforced Specimen



(a) Transverse Rebars



(b) Longitudinal Rebars

Figure 6.16. Covermeters Results for 8-inch Thickness Reinforced Specimen - Summary.

9.5-inches Thickness Reinforced Specimen (Small Rebars)

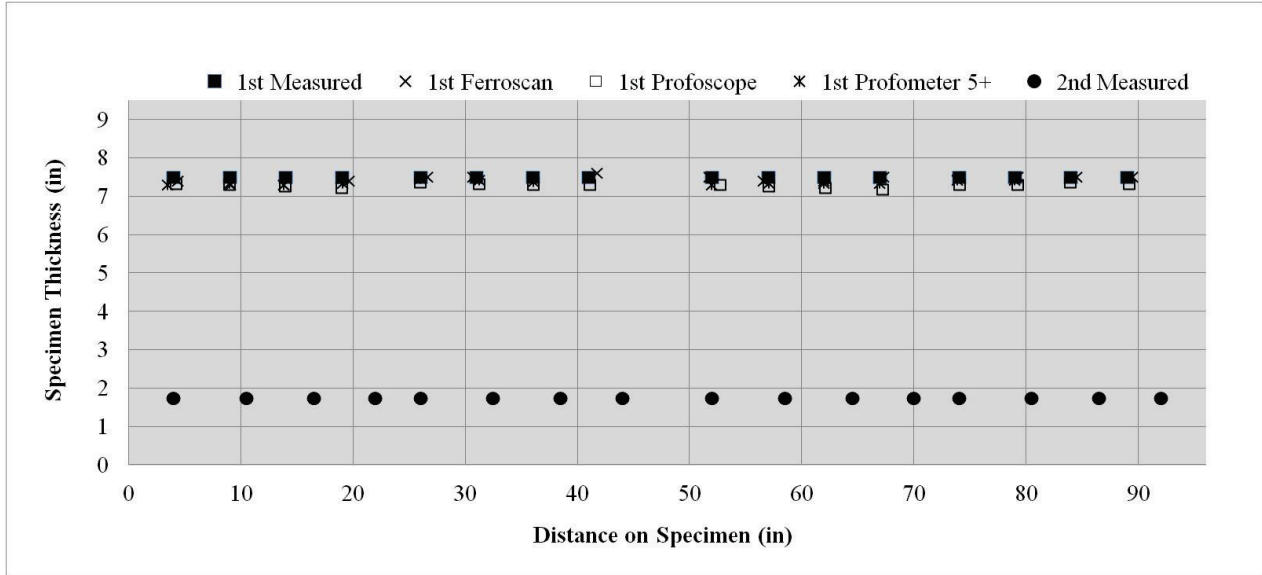

(a) Transverse Rebars

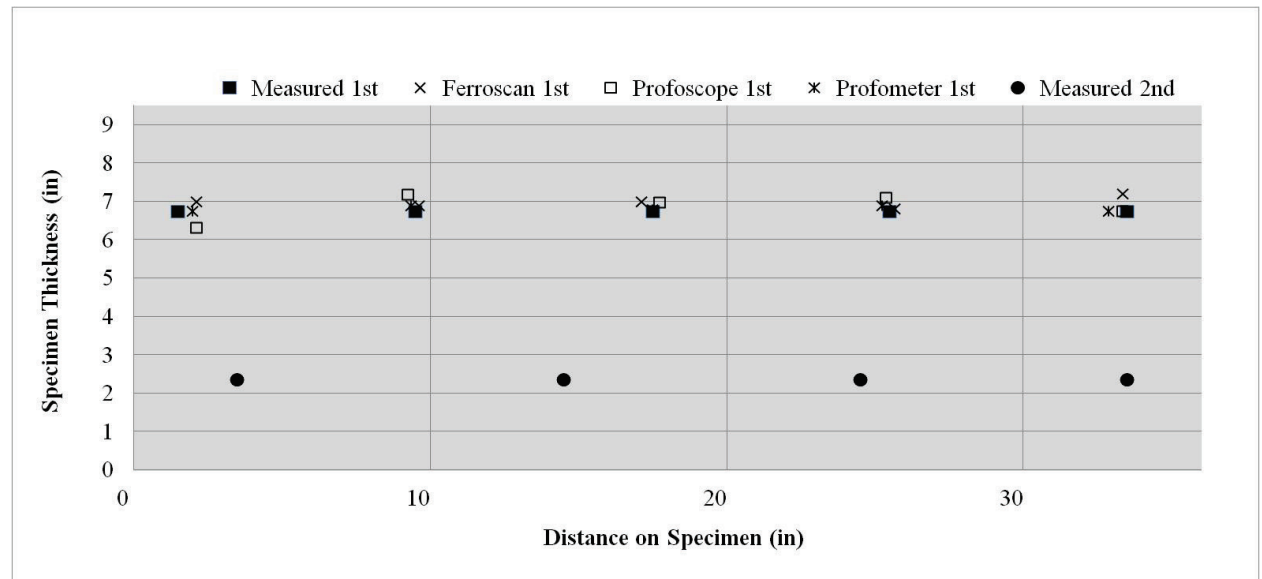

(b) Longitudinal Rebars

Figure 6.17. Covermeters Results for 9.5-inch Thickness Reinforced Specimen (Small Rebars) - Summary.

9.5-inches Thickness Reinforced Specimen (Big Rebars)

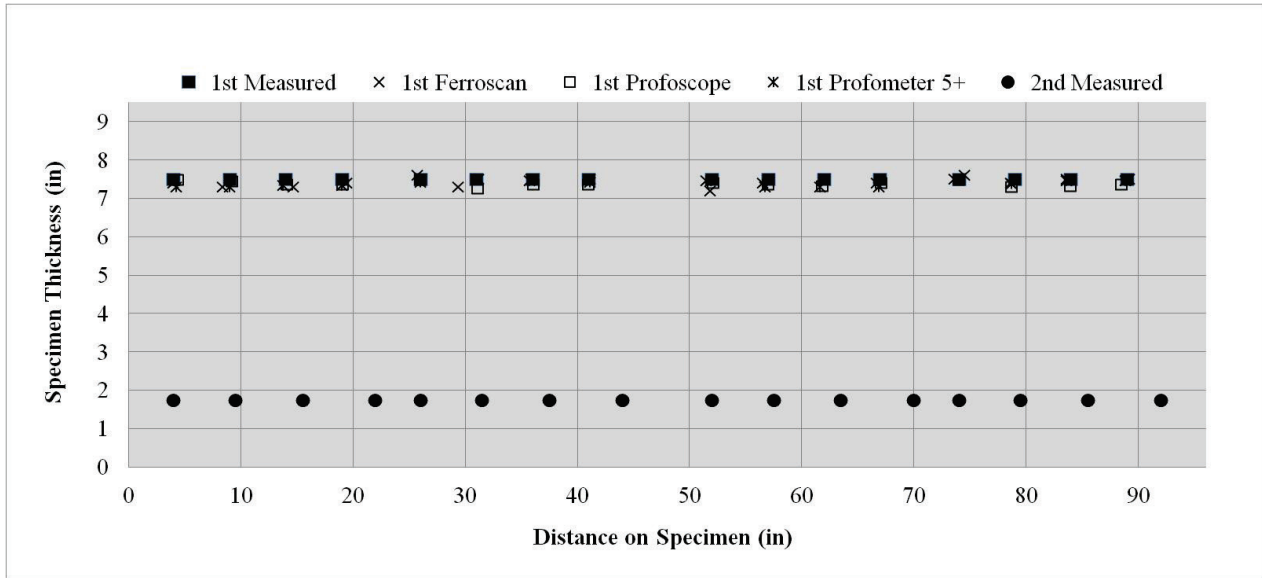

(a) Transverse Rebars

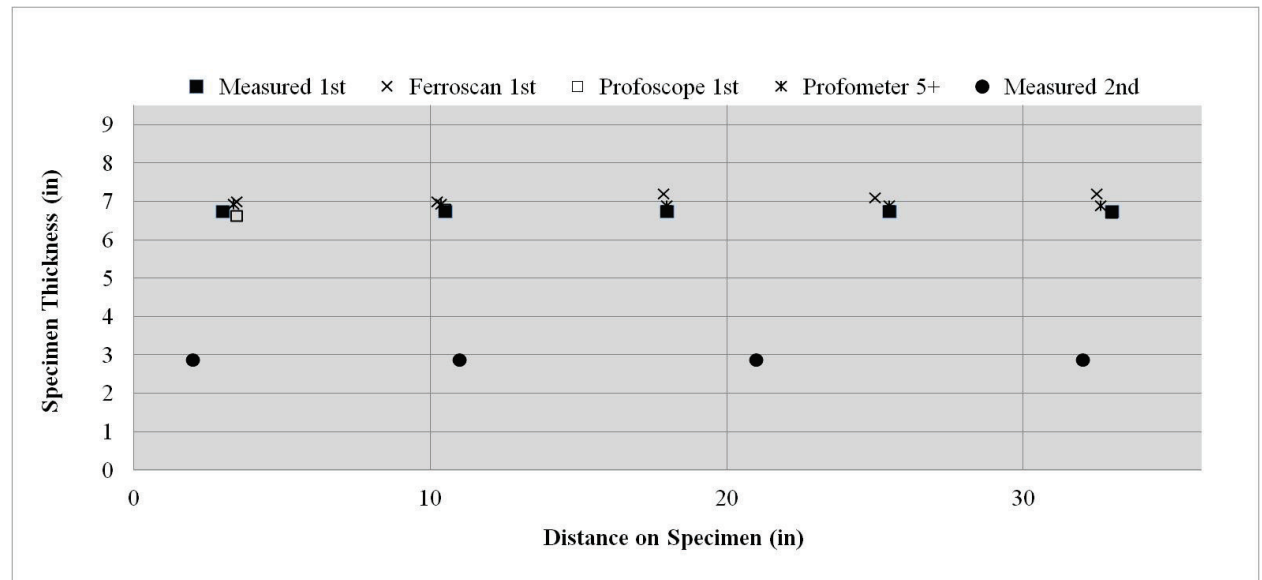

(b) Longitudinal Rebars

Figure 6.18. Covermeters Results for 9.5-inch Thickness Reinforced Specimen (Big Rebars) - Summary.

Rebar Size Detection

Following, rebar size detection data (for Transverse "T" and Longitudinal "L" rebars) obtained from scanning of the reinforced concrete specimens with Covermeter devices are summarized and compared (Tables 6.1 to 6.4). Highlighted tables cells represent the location of steel lifting studs in the concrete specimens. The inclusion of studs was necessary for proper moving of the specimens when required.

As for the Proceq devices (Profoscope⁺ and Profometer 5⁺), in order to have an approximation of the rebar size detected, indication of the rebar size was included in the device setting prior to specimen testing. Rebar size detection would be possible only if the user has already an approximate knowledge of the reinforcement size prior to testing.

As for the Hilti device (Ferroskan), it is not possible to determine bar sizes unless an ImageScan is performed (with use of a particular reference grid paper). In this study, only a QuickScan was performed because of time-related reasons. Quickscan can be used to quickly detect bar positions and depths that are then subsequently marked on the surface. This is procedure is named Quickscan detection. Accurate depth measurement is another Quickscan function in which values for bar diameter and bar spacing must be previously entered. Alternatively, data can be recorded and evaluated on the monitor or in the PC application. In this way, the average depth of cover over the reinforcement over large stretches of the surface can be easily determined. This is termed Quickscan recording. Imagescan is used to create an image of the reinforcement layout. The depth and diameter of the bars can be determined. First, a reference grid has to be fixed to the specimen (or, alternatively, a 4×4 grid with 150 mm spacing between parallel lines can be marked directly on the surface).

Table 6.1. Covermeters Rebar Size Detection Comparison for 7-inch Thickness Reinforced Specimen.

Rebars	Reinforced Concrete Specimen		Proceq				Hilti	
	7-inch		Profoscope ⁺		Profometer5 ⁺		Ferroskan PS200	
	T (#)	L (#)	T (#)	L (#)	T (in)	L (in)	T	L
1	5	5	7	7	0.77	0.79	N/A	N/A
2	5	5	7	7	0.78	0.84	N/A	N/A
3	5	5	7	7	0.77	0.86	N/A	N/A
4	5	5	7	4	0.77	0.82	N/A	N/A
5	6	5	8	10	0.89	1.49	N/A	N/A
6	6		8		0.87		N/A	
7	6		8		0.88		N/A	
8	6		8		0.9		N/A	
9	5		10		0.89		N/A	
10	5		7		0.76		N/A	
11	5		7		0.72		N/A	
12	5		7		0.71		N/A	
13	6		8		0.85		N/A	
14	6		9		0.85		N/A	
15	6		9		0.85		N/A	
16	6		7		0.81		N/A	

where rebar #4 = 0.500 inches
 #5 = 0.625 inches
 #6 = 0.750 inches

Table 6.2. Covermeters Rebar Size Detection Comparison for 8-inch Thickness Reinforced Specimen.

Rebars	Reinforced Concrete Specimen		Proceq				Hilti	
	8-inch		Profoscope ⁺		Profometer5 ⁺		Ferroskan PS200	
	T (#)	L (#)	T (#)	L (#)	T (in)	L (in)	T	L
1	5	4	10	5	0.77	N/A	N/A	N/A
2	5	4	13	6	0.85	0.58	N/A	N/A
3	5	4	9	8	0.81	0.54	N/A	N/A
4	5	4	10	5	0.86	0.49	N/A	N/A
5	6	4	8	6	0.74	0.58	N/A	N/A
6	6		10		0.75		N/A	
7	6		10		0.82		N/A	
8	6		13		0.88		N/A	
9	5		11		0.9		N/A	
10	5		9		0.8		N/A	
11	5		9		0.77		N/A	
12	5		7		0.76		N/A	
13	6		8		0.64		N/A	
14	6		8		0.64		N/A	
15	6		10		0.63		N/A	
16	6		7		0.6		N/A	

where rebar #4 = 0.500 inches
 #5 = 0.625 inches
 #6 = 0.750 inches

Table 6.3. Covermeters Rebar Size Detection Comparison for 9.5-inch Thickness Reinforced Specimen (Small Rebars).

Rebars	Reinforced Concrete Specimen		Proceq				Hilti	
	9.5-inch (Small Rebars)		Profoscope ⁺		Profometer5 ⁺		Ferroskan PS200	
	T (#)	L (#)	T (#)	L (#)	T (in)	L (in)	T	L
1	5	4	5	4	0.65	N/A	N/A	N/A
2	5	4	6	4	0.67	N/A	N/A	N/A
3	5	4	7	5	0.66	N/A	N/A	N/A
4	5	4	6	5	0.67	N/A	N/A	N/A
5	6	4	7	5	0.77	N/A	N/A	N/A
6	6		6		0.77		N/A	
7	6		6		0.76		N/A	
8	6		6		0.91		N/A	
9	5		10		0.74		N/A	
10	5		6		0.69		N/A	
11	5		5		0.69		N/A	
12	5		5		0.66		N/A	
13	6		6		0.76		N/A	
14	6		6		0.75		N/A	
15	6		6		0.76		N/A	
16	6		6		0.7		N/A	

where rebar #4 = 0.500 inches
 #5 = 0.625 inches
 #6 = 0.750 inches

Table 6.4. Covermeters Rebar Size Detection Comparison for 9.5-inch Thickness Reinforced Specimen (Big Rebars).

Rebars	Reinforced Concrete Specimen		Proceq				Hilti	
	9.5-inch (Big Rebars)		Profoscope ⁺		Profometer5 ⁺		Ferroskan PS200	
	T (#)	L (#)	T (#)	L (#)	T (in)	L (in)	T	L
1	8	5	6	N/A	0.75	N/A	N/A	N/A
2	8	5	6	N/A	0.82	N/A	N/A	N/A
3	8	5	6	8	0.77	N/A	N/A	N/A
4	8	5	5	8	0.78	N/A	N/A	N/A
5	9	5	7	8	0.9	N/A	N/A	N/A
6	9		8		1.08		N/A	
7	9		7		0.98		N/A	
8	9		11		1.15		N/A	
9	8		10		1.07		N/A	
10	8		8		0.98		N/A	
11	8		7		0.92		N/A	
12	8		7		0.86		N/A	
13	9		8		1		N/A	
14	9		11		1.01		N/A	
15	9		10		1.04		N/A	
16	9		7		0.86		N/A	

where rebar #4 = 0.500 inches
 #5 = 0.625 inches
 #6 = 0.750 inches
 #8 = 1.000 inches
 #9 = 1.128 inches

Comments

Capability of the covermeter devices was limited to the identification of the top rebar layer only. Localization of the steel reinforcement was fairly accurate in almost all cases and concrete coverage identification fell within 1-inch error in the worst cases. The covermeter devices were not capable of identifying the top rebar layer for the 10-inch reinforced specimen which included a 2-inch asphalt on the top. In this case, the top rebars laid between 4 and 5 inches from the top surface.

When covermeter devices were preset with an estimate of the rebar diameter to facilitate the identification of the rebar sizes detected, still in very few cases the devices were able to correctly detect the rebar sizes. Also, the correct identification of rebar diameters was influenced by the overlapping of rebars and by sometimes the presence of steel lifting studs in the concrete specimen.

There was no need to repeat the scanning of the concrete specimens when they were elevated from the ground, since this different testing condition would have not influenced the results with use of the covermeter technology. Overall, the researchers feel that all three devices employed had a very similar performance in terms of top layer rebar locator and concrete coverage identification.

CHAPTER 7. CONCLUSIONS AND IMPLEMENTATION

The objective of this study was to perform a literature search to determine the current NDT methods available for detecting locations of the reinforcing steel in bridge decks. Using NDT methods contractors can accurately locate the placement of the concrete barrier rails in reference to reinforcing steel during construction. Two technologies were identified by the researchers as primary methodologies used in the field of rebar detection in reinforced concrete: magnetic method (covermeters) and ground penetrating radar. Each method was researched to determine devices available for use on the market, equipment costs, device features, performance, and advantages/disadvantages for each technology evaluated.

Reinforced concrete specimens were purposely built to test the capabilities of each rebar locator device considered, in terms of steel bar localization and concrete coverage for both top and bottom reinforced layers. Concrete specimen thickness, and rebar sizes and spacing varied in order to have different configurations to test.

A total of four GPR devices were made available for use in this research study: StructureScan MiniHD (GSSI), PS1000 X-Scan (Hilti), Handy Search (JRC/Proceq), and Aladdin System (IDS/Olson Instruments, Inc.). Chapters 5 and 6 report data obtained from on-site scanning of the concrete specimens with these GPR devices and data after post-processing the on-site results.

GPR DEVICES

1-inch Accuracy Results Evaluation

On-Site Accuracy Comparison

Tables 7.1 and 7.2 and Figures 7.1 to 7.6 summarize the capability of the GPR devices used in this research study in terms of locating rebar layers in concrete specimens and identifying their concrete coverage. This data is referring to on-site evaluation, thus it summarizes the GPR devices capability to locate rebars and their concrete coverage without use of post-processing software. For each concrete specimen, TTI researchers evaluated the number of rebars (T=Transverse and L=Longitudinal) identified by a particular GPR device within 1-inch accuracy from their real location (Table 7.1). Also, Table 7.2 summarizes the detected rebar concrete coverage within 1-inch accuracy from their real value. This means, every time the GPR device was capable of detecting the rebar top concrete coverage within 1-inch accuracy from their real value, a point was awarded to the device. Thus, if there are 16 rebars in the longitudinal direction of the concrete specimen, the GPR device can be awarded of a maximum of 16 points (this would be the case when the device detects within 1-inch accuracy the concrete coverage of all 16 rebars.).

Table 7.1. On-Site Summary GPR Results - Rebar Location.

Concrete Reinforcement Specimens	# Steel Bars	GSSI	Proceq-JRC	Hilti	Olson Eng.-IDS	
7" -Ground- TOP	T:	16	16	15	16	14
	L:	5	3	1	5	4
7" -Ground- BOTTOM	T:	16	2	4	NA	5
	L:	4	0	0	NA	1
8" -Ground- TOP	T:	16	16	15	13	15
	L:	5	3	3	4	4
8" -Ground- BOTTOM	T:	16	NA	1	11	4
	L:	4	NA	1	4	3
9.5" SR -Ground- TOP	T:	16	15	15	15	16
	L:	5	3	3	5	3
9.5" SR -Ground- BOTTOM	T:	16	NA	2	NA	11
	L:	4	NA	2	2	3
9.5" BR -Ground - TOP	T:	16	15	14	16	16
	L:	5	4	3	4	4
9.5" BR -Ground - BOTTOM	T:	16	NA	2	NA	8
	L:	4	2	2	2	3
8"+2" -Ground - TOP	T:	16	15	10	16	13
	L:	5	3	3	3	3
8"+2" -Ground - BOTTOM	T:	16	NA	2	3	8
	L:	4	1	0	1	1
8"+2" -Elevated - TOP	T:	16	15	15	11	13
	L:	5	3	3	NA	3
8"+2" -Elevated- BOTTOM	T:	16	NA	4	4	3
	L:	4	1	3	NA	2
TOTAL TOP	T:	96	92	84	87	87
	L:	30	19	16	21 + 1 NA	21
TOTAL BOTTOM	T:	96	2 + 5 NA	15	18 + 3 NA	39
	L:	24	4 + 2 NA	8	9 + 2 NA	13

Table 7.2. On-Site Summary GPR Results - Rebar Concrete Coverage.

Concrete Reinforcement Specimens	# Steel Bars		GSSI	Proceq-JRC	Hilti	Olson Eng.-IDS
	T:	L:				
7" -Ground- TOP	T:	16	16	15	16	14
	L:	5	3	3	5	5
7" -Ground- BOTTOM	T:	16	NA	13	NA	NA
	L:	4	2	2	NA	NA
8" -Ground- TOP	T:	16	16	15	13	16
	L:	5	3	3	4	4
8" -Ground- BOTTOM	T:	16	NA	6	11	16
	L:	4	NA	2	4	4
9.5" SR -Ground- TOP	T:	16	15	15	15	16
	L:	5	3	3	5	5
9.5" SR -Ground- BOTTOM	T:	16	NA	14	NA	16
	L:	4	NA	3	4	3
9.5" BR -Ground - TOP	T:	16	15	15	16	NA
	L:	5	4	3	4	5
9.5" BR -Ground - BOTTOM	T:	16	NA	13	NA	0
	L:	4	2	2	2	NA
8"+2" -Ground - TOP	T:	16	15	15	NA	16
	L:	5	3	3	NA	3
8"+2" -Ground - BOTTOM	T:	16	NA	10	NA	0
	L:	4	NA	3	NA	3
8"+2" -Elevated - TOP	T:	16	NA	15	NA	16
	L:	5	NA	3	NA	3
8"+2" -Elevated- BOTTOM	T:	16	NA	4	NA	9
	L:	4	NA	3	NA	3
TOTAL TOP	T:	96	77 + 1 NA	90	60 + 2 NA	78 + 1 NA
	L:	30	16 + 1 NA	18	18 + 2 NA	25
TOTAL BOTTOM	T:	96	6 NA	60	11 + 5 NA	41 + 1 NA
	L:	24	4 + 4 NA	15	10 + 3 NA	13 + 2 NA

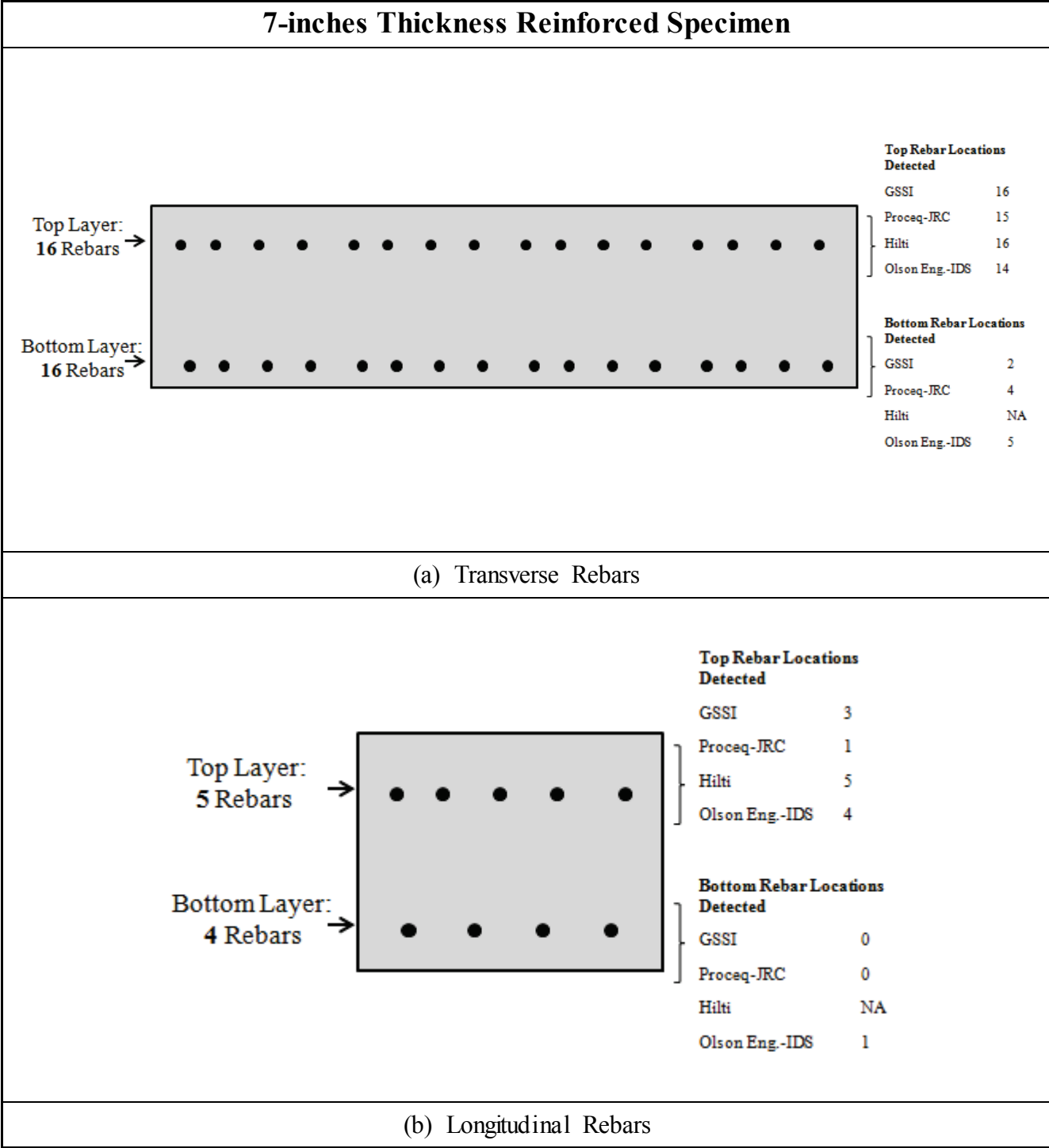

Figure 7.1. On-Site GPR Rebar Location Results for 7-inch Thickness Reinforced Specimen - SUMMARY.

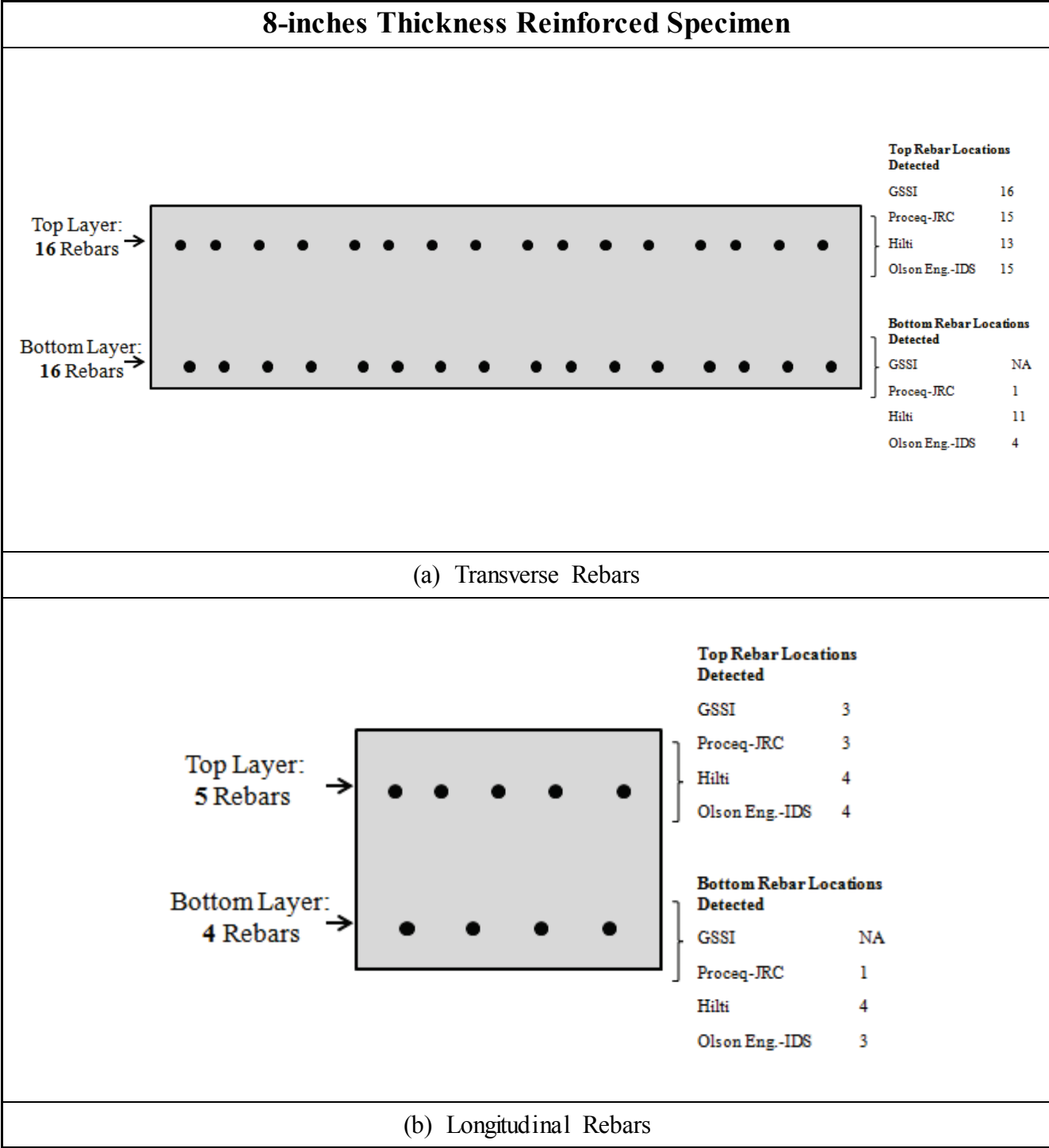
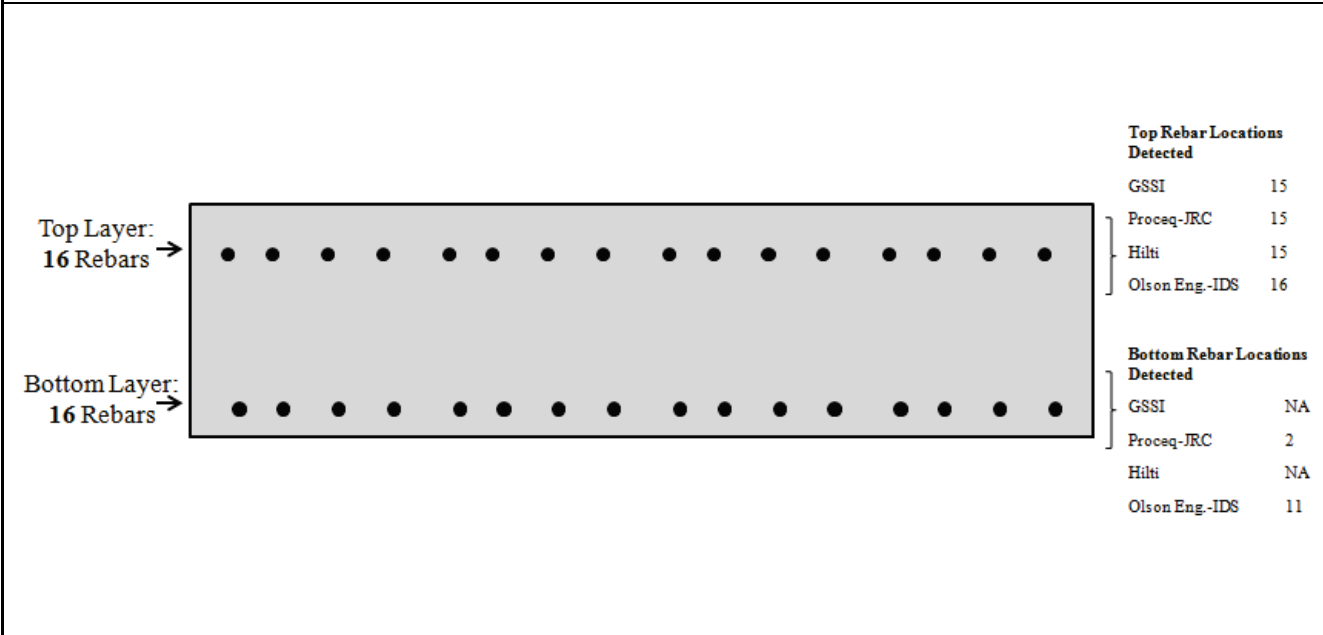
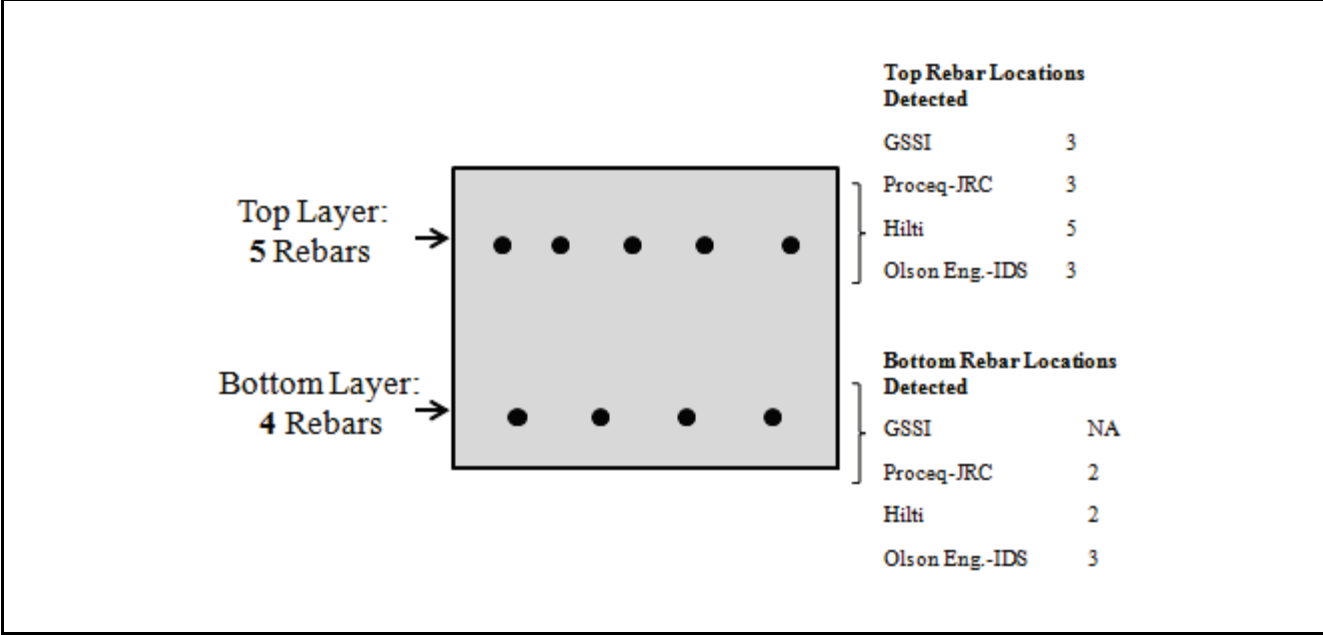

Figure 7.2. On-Site GPR Rebar Location Results for 8-inch Thickness Reinforced Specimen - SUMMARY.

9.5-inches Thickness Reinforced Specimen (Small Rebars)



(a) Transverse Rebars



(b) Longitudinal Rebars

Figure 7.3. On-Site GPR Rebar Location Results for 9.5-inch Thickness Reinforced Specimen (Small Rebars) - SUMMARY.

9.5-inches Thickness Reinforced Specimen (Big Rebars)

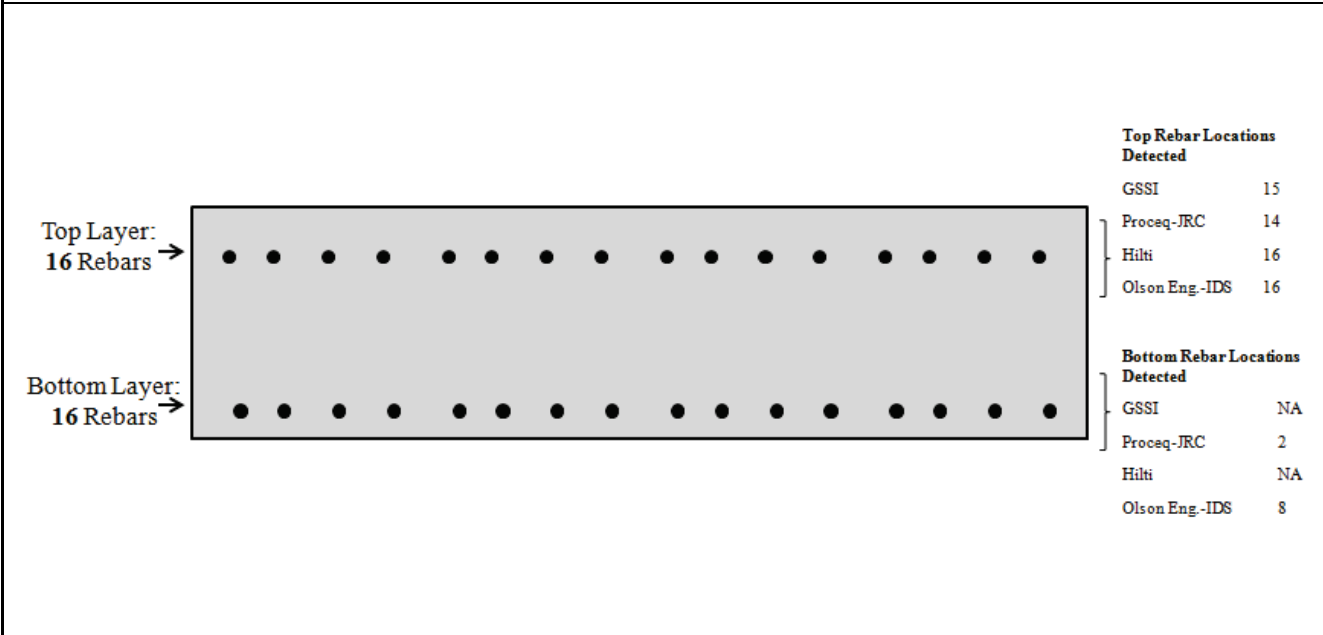

(a) Transverse Rebars

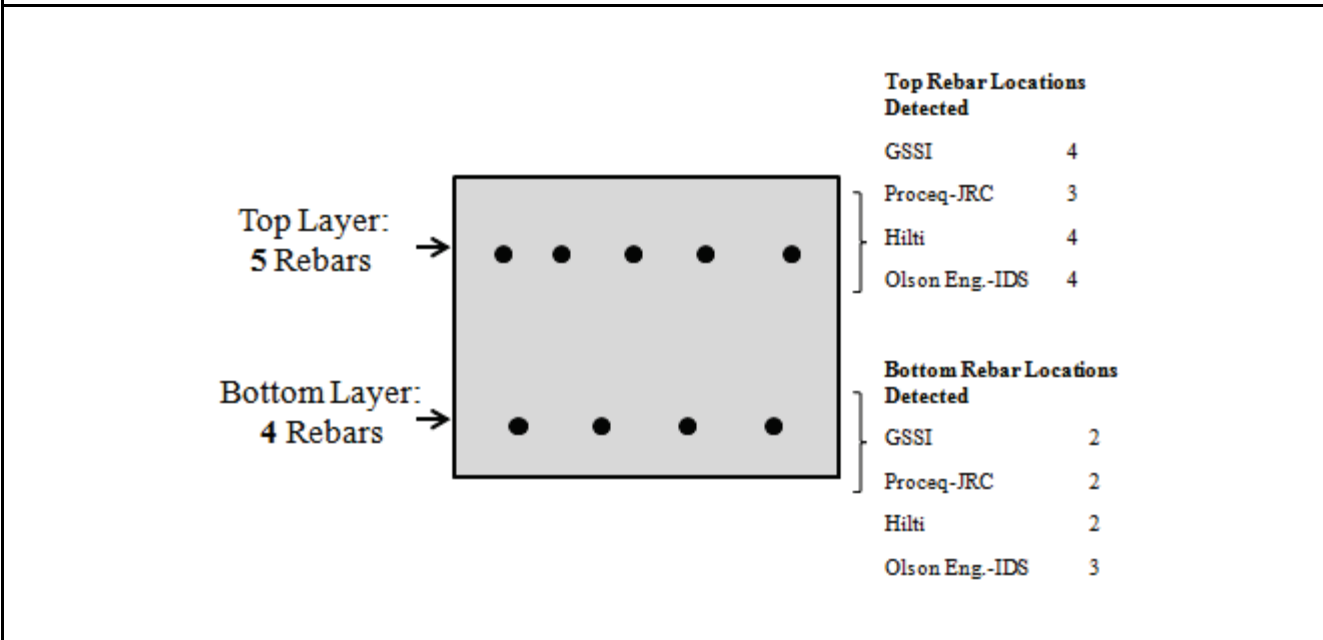

(b) Longitudinal Rebars

Figure 7.4. On-Site GPR Rebar Location Results for 9.5-inch Thickness Reinforced Specimen (Big Rebars) - SUMMARY.

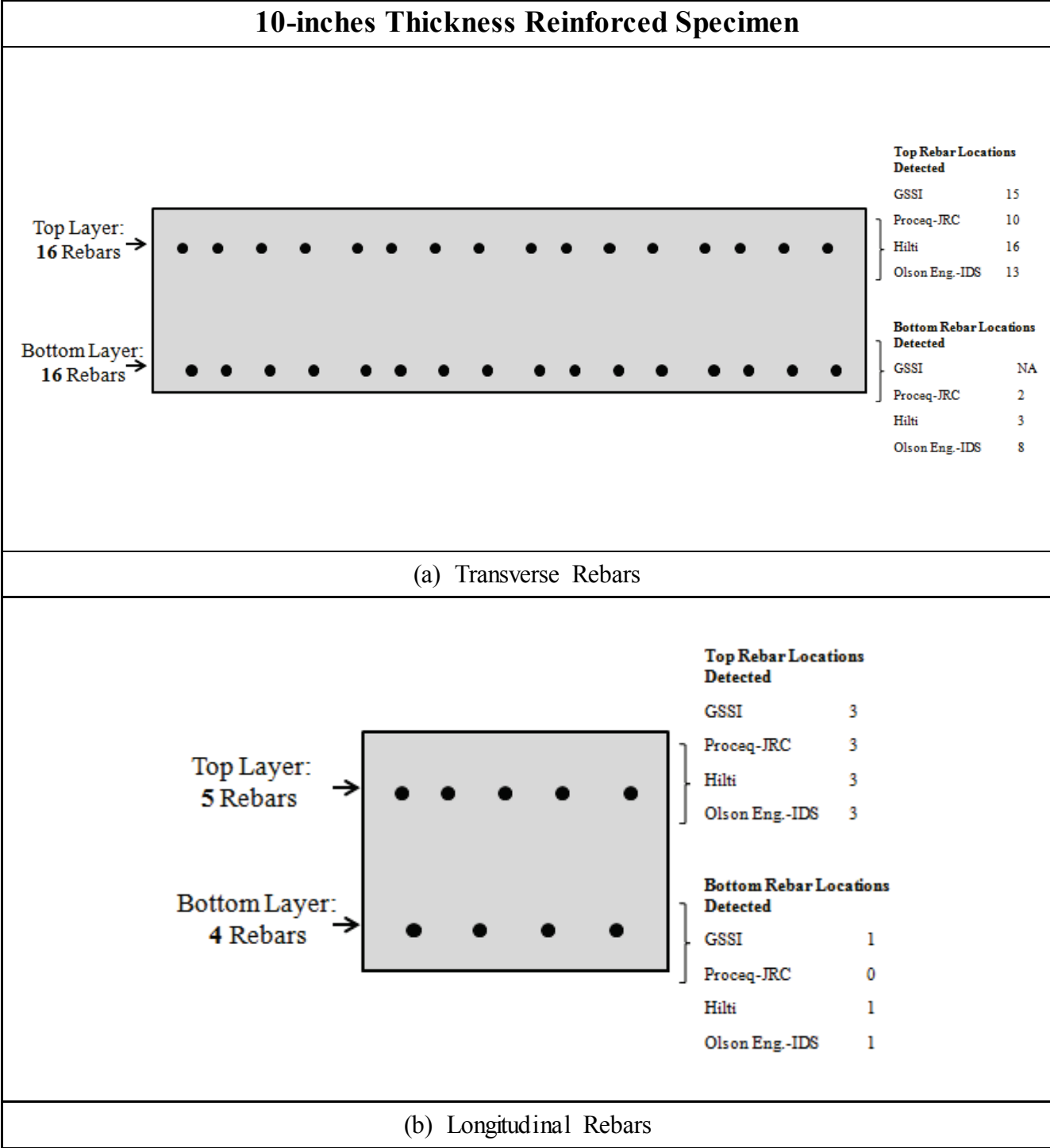

Figure 7.5. On-Site GPR Rebar Location Results for 10-inch Thickness Reinforced Specimen - SUMMARY.

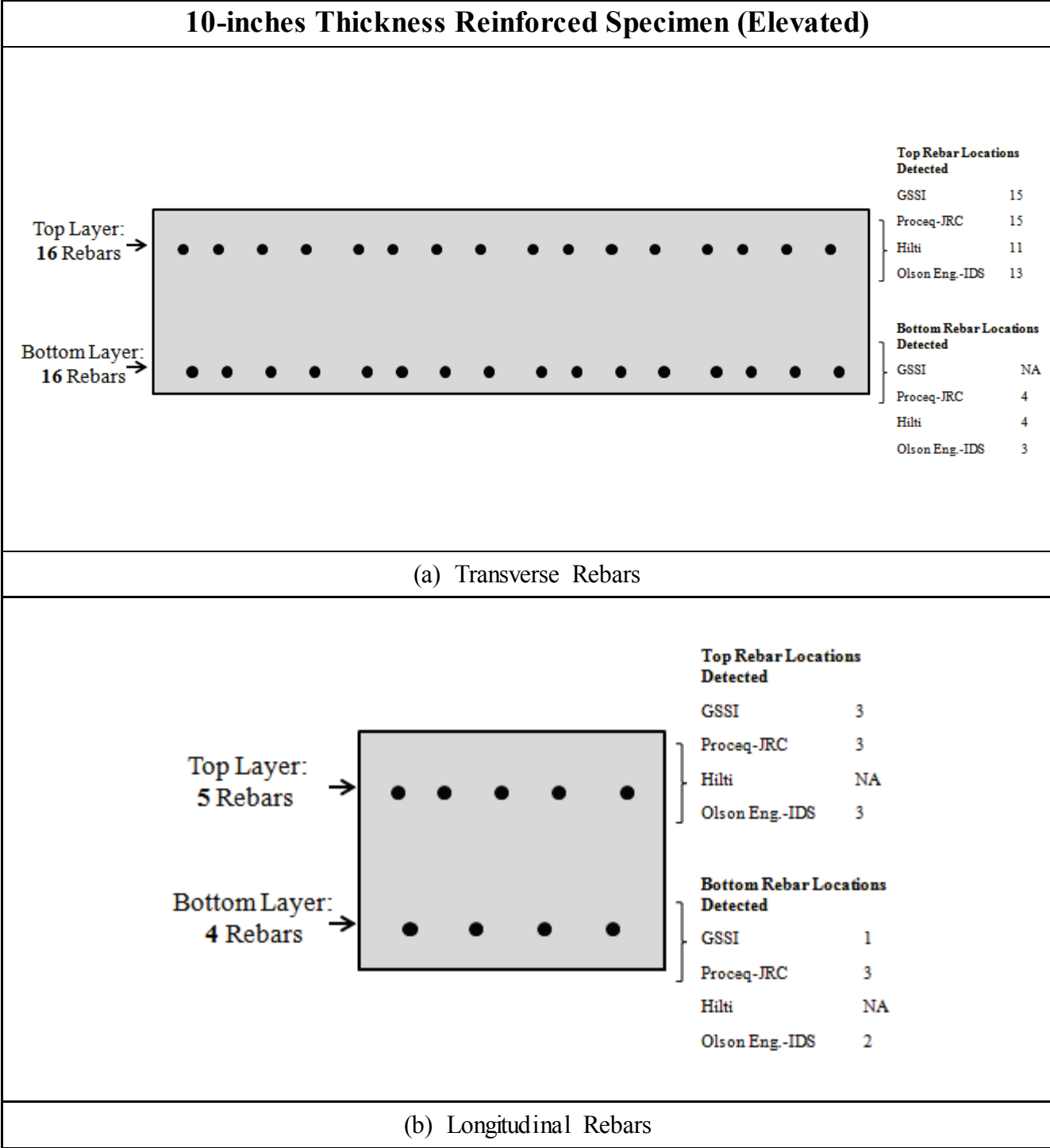

Figure 7.6. On-Site GPR Rebar Location Results for 10-inch Thickness Reinforced Specimen (Elevated) - SUMMARY.

Post-Processed Accuracy Comparison

Tables 7.3 and 7.4 and Figures 7.7 to 7.12 summarize the capability of the GPR devices used in this research study in terms of locating rebar layers in concrete specimens and identifying their concrete coverage. This data is referring to post-processed evaluation, thus it summarizes the GPR devices capability to locate rebars and their concrete coverage after use of post-processing software. For each concrete specimen, TTI researchers evaluated the number of rebars identified by a particular GPR device within 1-inch accuracy from their real location (Table 7.3). Also, Table 7.4 summarizes the detected rebar concrete coverage within 1-inch accuracy from their real value. This means, every time the GPR device was capable of detecting the rebar top concrete coverage within 1-inch accuracy from their real value, a point was awarded to the device. Thus, if there are 16 rebars in the longitudinal direction of the concrete specimen, the GPR device can be awarded of a maximum of 16 points (this would be the case when the device detects within 1-inch accuracy the concrete coverage of all 16 rebars.).

Ease of Use Comparison

"Ease of Use" includes the easiness of understanding the setup process and of operating the device; also, it includes the handiness and convenience for use of the device in different conditions. Employed GPR devices were similar for their *modi operandi*, however TTI researchers highlighted some interesting differences among certain devices for a 2D scanning process. TTI researchers did not have enough experience during this project to evaluate the GPR devices according to their easiness of use and capability for performing 3D scanning images.

The SS MiniHR Unit (GSSI), the PS1000 X-Scan (Hilti) and the Handy Search (JRC/Proceq) devices are all-in-one concrete inspection tools (antenna, positioning system and control unit combo). They allow for visualization of the scanned data directly on the scanning device screen. This capability allows the user to easily monitor the data while scanning the specimen. With the Aladdin system (IDS/Olson Instruments), the specimen scan is performed with the Full-Polar Antenna but the scanned data are displayed on a GPR Computer (laptop). Thus, the user would need to have the GPR Computer close to him/her in order to visualize the displayed data. Also, the Full-Polar Antenna of the Aladdin system needs to be connected to a Control Unit via cable. The user would have to move the Control Unit as he/she progresses in scanning the specimen.

The SS MiniHR Unit (GSSI) has laser on its sides which help indicate the location on the concrete surface of the center of the identified target, allowing for an accurate marking of the embedded targets.

The PS1000 X-Scan (Hilti) allows the user to visualize the scanned data with different options: one of them allows direct visualization of rebar sections in the concrete. This type of visualization eases rebars identification without much need of data interpretation.

Table 7.3. Post-Processed GPR Results - Rebar Location.

Concrete Reinforcement Specimens	# Steel Bars		GSSI	Proceq-JRC	Hilti	Olson Eng.-IDS
	T:	L:				
7" -Ground-TOP	T:	16	16	3	16	10
	L:	5	3	3	5	0
7" -Ground-BOTTOM	T:	16	16	3	13	2
	L:	4	0	0	3	0
8" -Ground-TOP	T:	16	16	1	16	11
	L:	5	4	3	3	2
8" -Ground-BOTTOM	T:	16	16	2	15	0
	L:	4	4	0	1	1
9.5" SR -Ground-TOP	T:	16	16	3	10	4
	L:	5	3	2	5	4
9.5" SR -Ground-BOTTOM	T:	16	14	3	9	1
	L:	4	3	1	0	2
9.5" BR -Ground -TOP	T:	16	8	3	16	6
	L:	5	4	2	0	5
9.5" BR -Ground -BOTTOM	T:	16	7	3	12	2
	L:	4	2	0	1	0
8"+2" -Ground -TOP	T:	16	16	4	16	12
	L:	5	3	1	3	3
8"+2" -Ground -BOTTOM	T:	16	12	5	6	2
	L:	4	2	1	1	1
8"+2" -Elevated -TOP	T:	16	16	4	16	14
	L:	5	3	3	3	3
8"+2" -Elevated-BOTTOM	T:	16	11	5	6	1
	L:	4	3	2	0	2
TOTAL TOP	T:	96	88	18	90	57
	L:	30	20	14	19	17
TOTAL BOTTOM	T:	96	76	21	61	8
	L:	24	14	4	6	6

Table 7.4. Post-Processed GPR Results - Rebar Concrete Coverage.

Concrete Reinforcement Specimens	# Steel Bars	GSSI	Proceq-JRC	Hilti	Olson Eng.-IDS	
7" -Ground- TOP	T:	16	16	15	16	16
	L:	5	3	3	5	3
7" -Ground- BOTTOM	T:	16	16	15	14	7
	L:	4	3	2	3	2
8" -Ground- TOP	T:	16	16	15	16	16
	L:	5	4	3	5	5
8" -Ground- BOTTOM	T:	16	16	0	16	3
	L:	4	4	3	3	1
9.5" SR -Ground- TOP	T:	16	16	16	16	16
	L:	5	3	3	5	4
9.5" SR -Ground- BOTTOM	T:	16	14	0	6	3
	L:	4	4	0	4	3
9.5" BR -Ground - TOP	T:	16	8	16	16	16
	L:	5	4	5	5	5
9.5" BR -Ground - BOTTOM	T:	16	7	0	12	0
	L:	4	2	4	3	2
8"+2" -Ground - TOP	T:	16	16	16	0	15
	L:	5	3	3	0	3
8"+2" -Ground - BOTTOM	T:	16	13	0	0	4
	L:	4	2	0	0	2
8"+2" -Elevated - TOP	T:	16	16	15	0	16
	L:	5	3	3	0	3
8"+2" -Elevated- BOTTOM	T:	16	13	0	0	5
	L:	4	3	2	0	0
TOTAL TOP	T:	96	88	93	64	95
	L:	30	20	20	20	23
TOTAL BOTTOM	T:	96	79	15	48	22
	L:	24	18	11	13	10

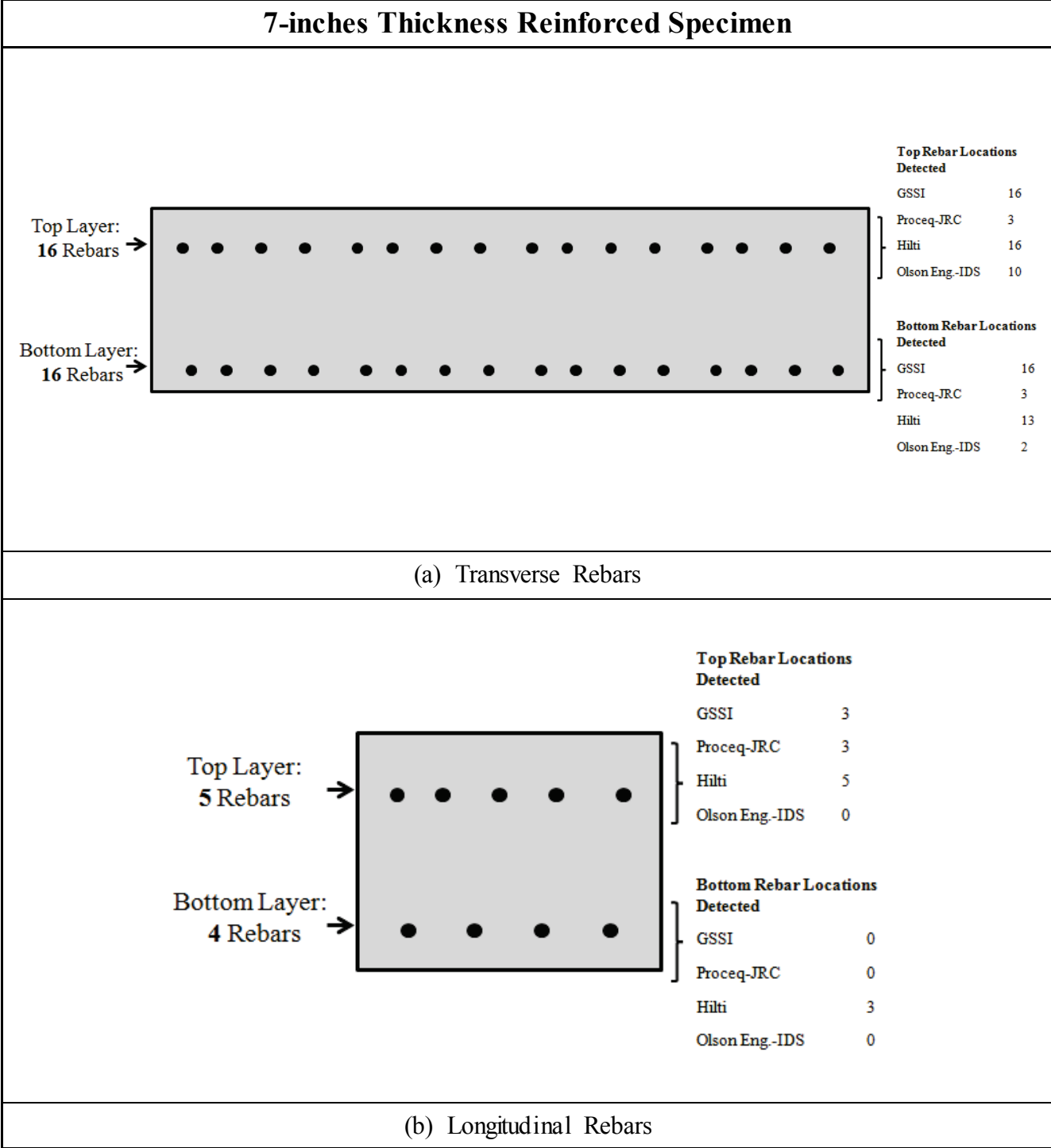

Figure 7.7. Post-Processed GPR Rebar Location Results for 7-inch Thickness Reinforced Specimen - SUMMARY.

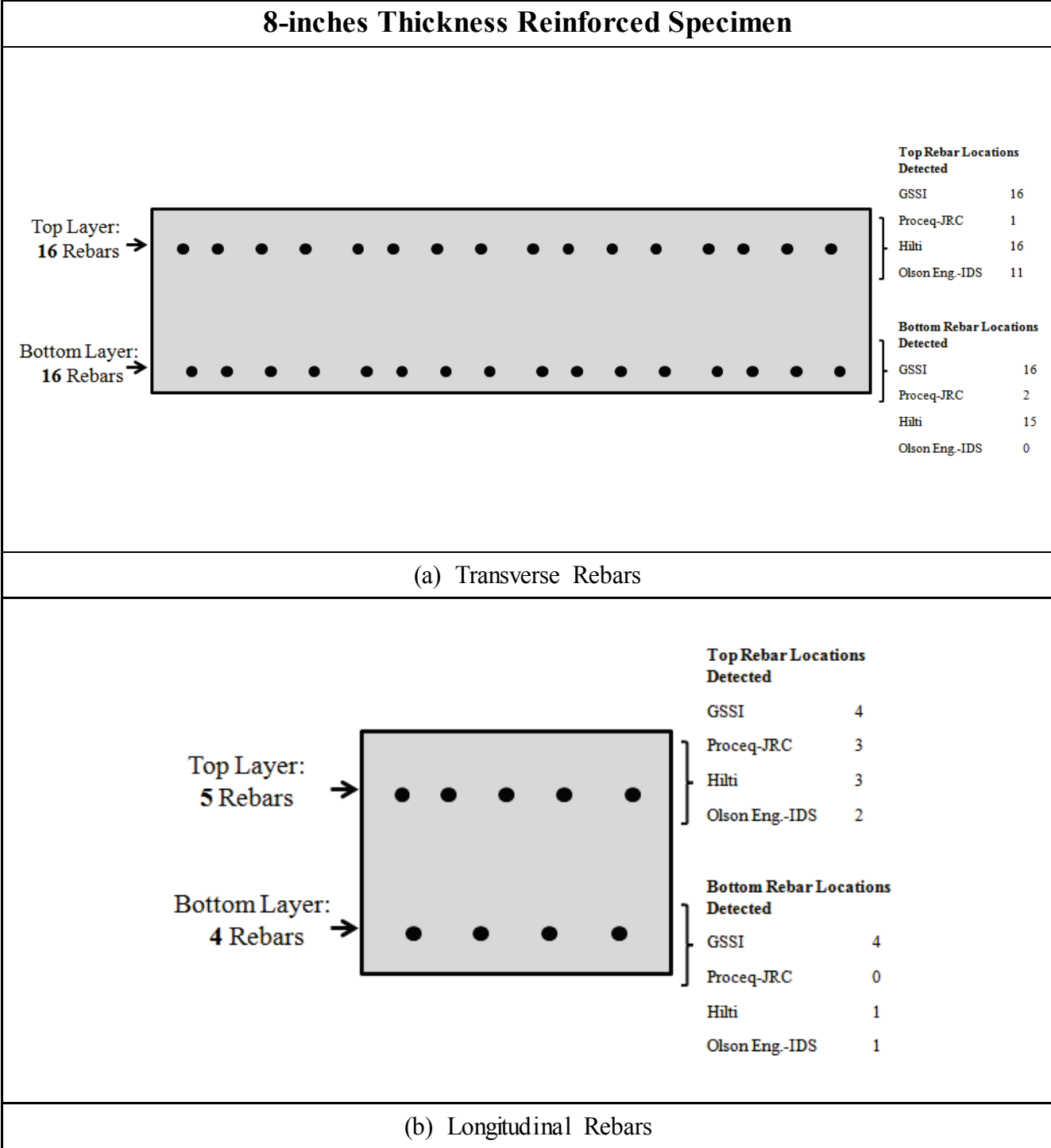

Figure 7.8. Post-Processed GPR Rebar Location Results for 8-inch Thickness Reinforced Specimen - SUMMARY.

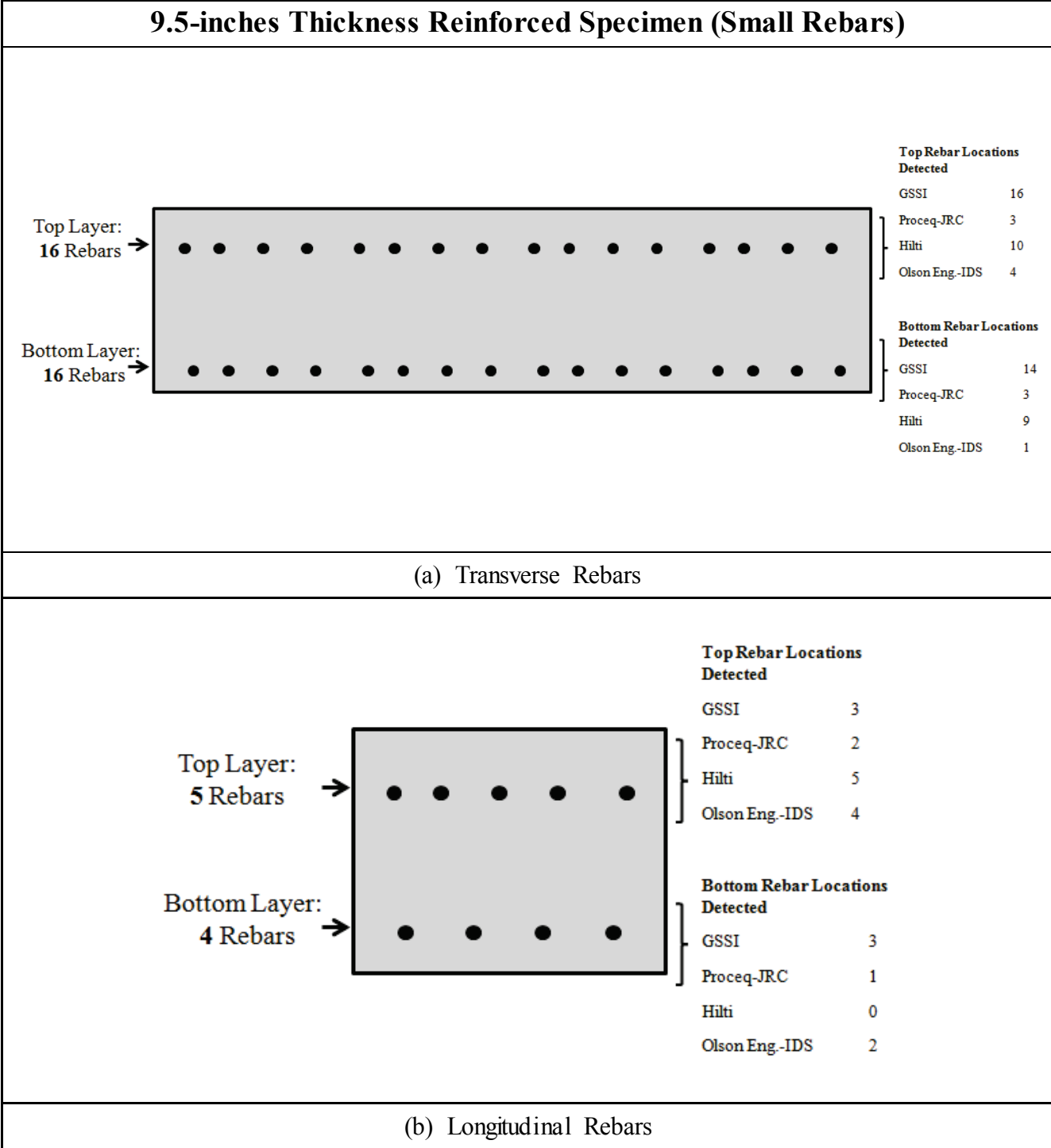

Figure 7.9. Post-Processed GPR Rebar Location Results for 9.5-inch Thickness Reinforced Specimen (Small Rebars) - SUMMARY.

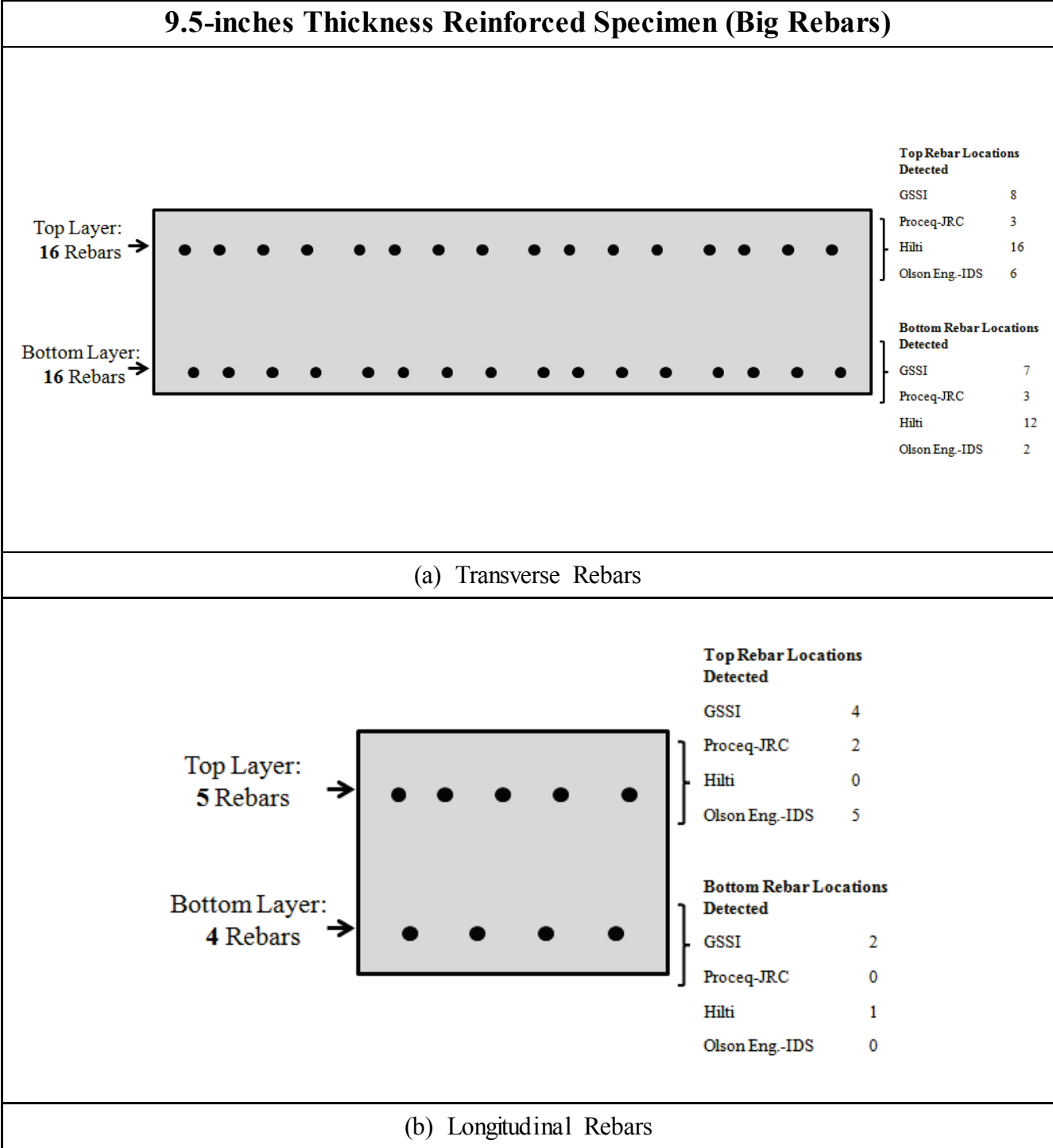

Figure 7.10. Post-Processed GPR Rebar Location Results for 9.5-inch Thickness Reinforced Specimen (Big Rebars) - SUMMARY.

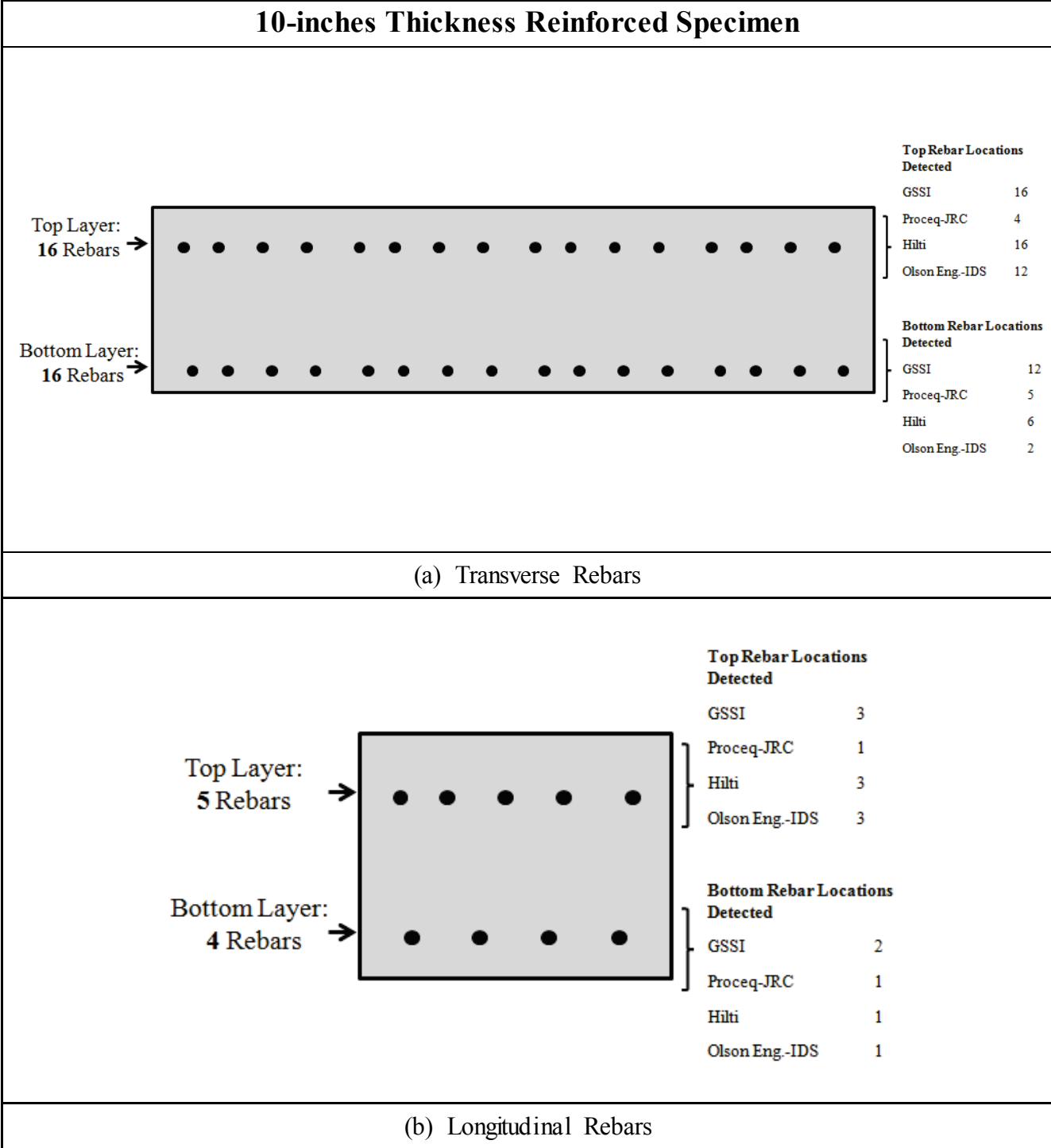

Figure 7.11. Post-Processed GPR Rebar Location Results for 10-inch Thickness Reinforced Specimen - SUMMARY.

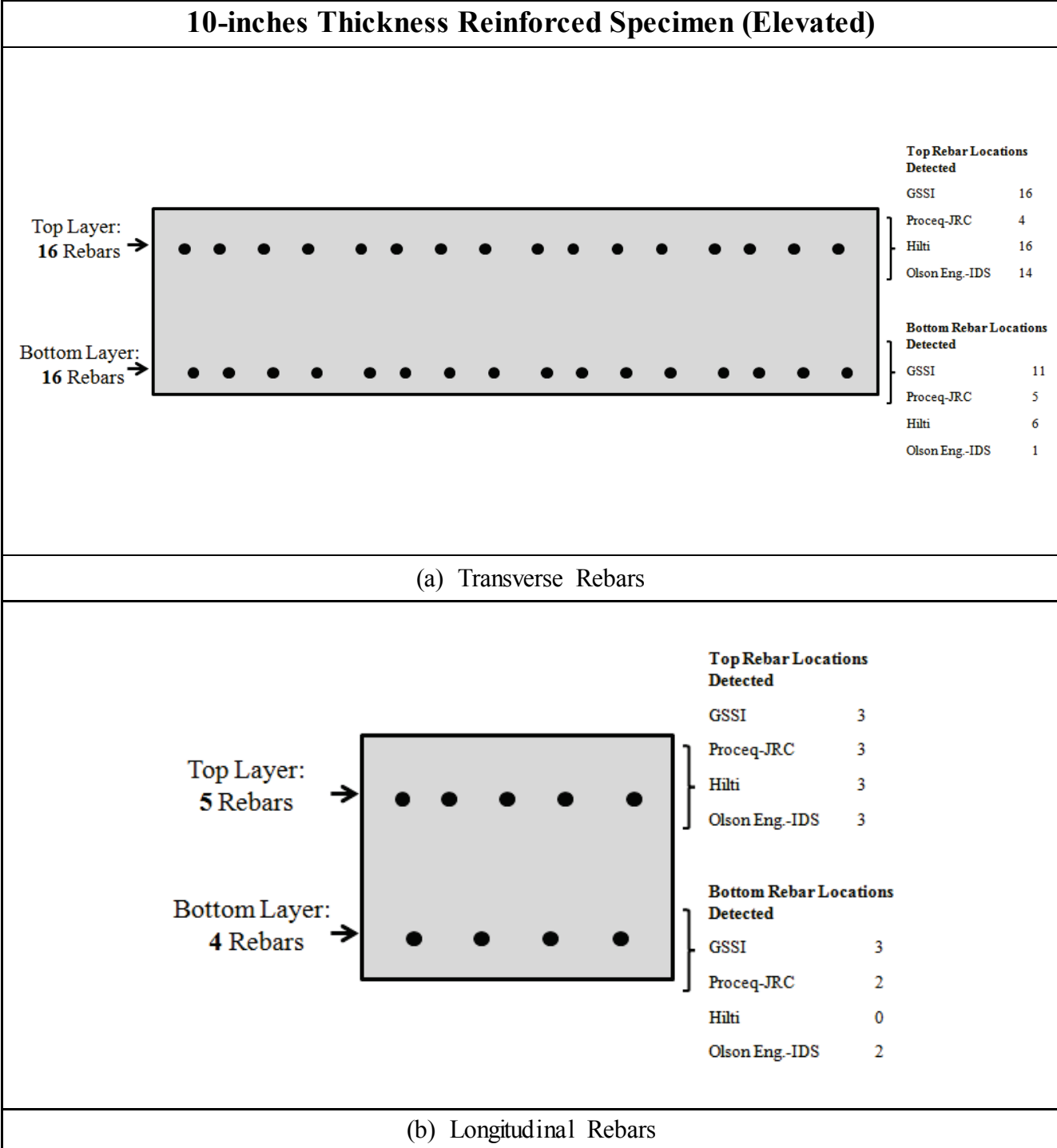

Figure 7.12. Post-Processed GPR Rebar Location Results for 10-inch Thickness Reinforced Specimen (Elevated) - SUMMARY.

Need of Training Comparison

In order to be able to use a GPR device to its full capabilities and to correctly interpret the collected results, the user needs to undergo a training process. The employed GPR devices display the cross section of the reinforcing steel bar as an angular image. The peak of the steel bar is the center of the angular image. When multiple steel grids are present in the reinforced concrete, the user needs to be careful to correctly interpret the curves displayed by the device. If proper training is not received, ringing effect can be misinterpreted for existence of lower steel bars (ringing effect occurs when lower curves are simply multiple reflections of upper curves, but do not indicate existence of lower steel bars). If the slopes of the upper and lower curves are similar, the user needs to be capable to correctly interpret the data by evaluating the slope of the curves. Also, once the angular image of possible lower rebars is identified, the user needs to be capable to determine whether the echo is the cross point of the upper echo's ends or if it is the echo of a lower rebar.

The Hilti GPR device (PS1000 X-Scan) allows the user to visualize the scanned data with different options: one of them allows direct visualization of rebar sections in the concrete. The experience that TTI researchers had with this type of visualization with the Hilti device allowed them to quickly locate rebars without much need of data interpretation.

Price Comparison

TTI researchers suggested that anyone interested in knowing the price for purchase a particular device, he/she would personally contact the Company directly. GPR devices can be offered with 2D or 3D capabilities, with or without post-processor program. GPR devices prices range from \$12,000 to \$32,000 approximately.

COVERMETER DEVICES

1-inch Accuracy Results Evaluation

A total of three covermeter devices were employed in this research study: Profoscope⁺ (Proceq), Profometer5⁺ (Proceq), and Ferrosan PS200 (Hilti). Tables 7.5 and 7.6 and Figures 7.13 to 7.17 summarize the capability of the covermeter devices used in this research study in terms of locating rebar layers in concrete specimens and identifying their concrete coverage. For each concrete specimen, TTI researchers evaluated the number of rebars identified by a particular covermeter device within 1-inch accuracy from their real location (Table 7.5). Also, Table 7.6 summarizes the detected rebar concrete coverage within 1-inch accuracy from their real value. This means, every time the covermeter device was capable of detecting the rebar top concrete coverage within 1-inch accuracy from their real value, a point was awarded to the device. Thus, if there are 16 rebars in the longitudinal direction of the concrete specimen, the covermeter device can be awarded of a maximum of 16 points (this would be the case when the device detects within 1-inch accuracy the concrete coverage of all 16 rebars.).

Table 7.5. Covermeters Results - Rebar Location.

Concrete Reinforcement Specimens	# Steel Bars	Proceq Profoscope+	Proceq Profometer 5+	Hilti Ferrosan
7" -Ground- TOP	T:	16	16	16
	L:	5	4	5
8" -Ground- TOP	T:	16	16	16
	L:	5	5	5
9.5" SR -Ground- TOP	T:	16	16	16
	L:	5	5	5
9.5" BR -Ground - TOP	T:	16	16	15
	L:	5	5	5
8"+2" -Elevated - TOP	T:	16	0	0
	L:	5	0	0
TOTAL TOP	T:	80	64	63
	L:	25	19	20

Table 7.6. Covermeters Results - Rebar Concrete Coverage.

Concrete Reinforcement Specimens	# Steel Bars	Proceq Profoscope+	Proceq Profometer 5+	Hilti Ferrosan
7" -Ground- TOP	T:	16	16	16
	L:	5	5	5
8" -Ground- TOP	T:	16	16	16
	L:	5	5	5
9.5" SR -Ground- TOP	T:	16	16	16
	L:	5	5	5
9.5" BR -Ground - TOP	T:	16	16	15
	L:	5	5	5
8"+2" -Elevated - TOP	T:	16	0	0
	L:	5	0	0
TOTAL TOP	T:	80	64	63
	L:	25	20	20

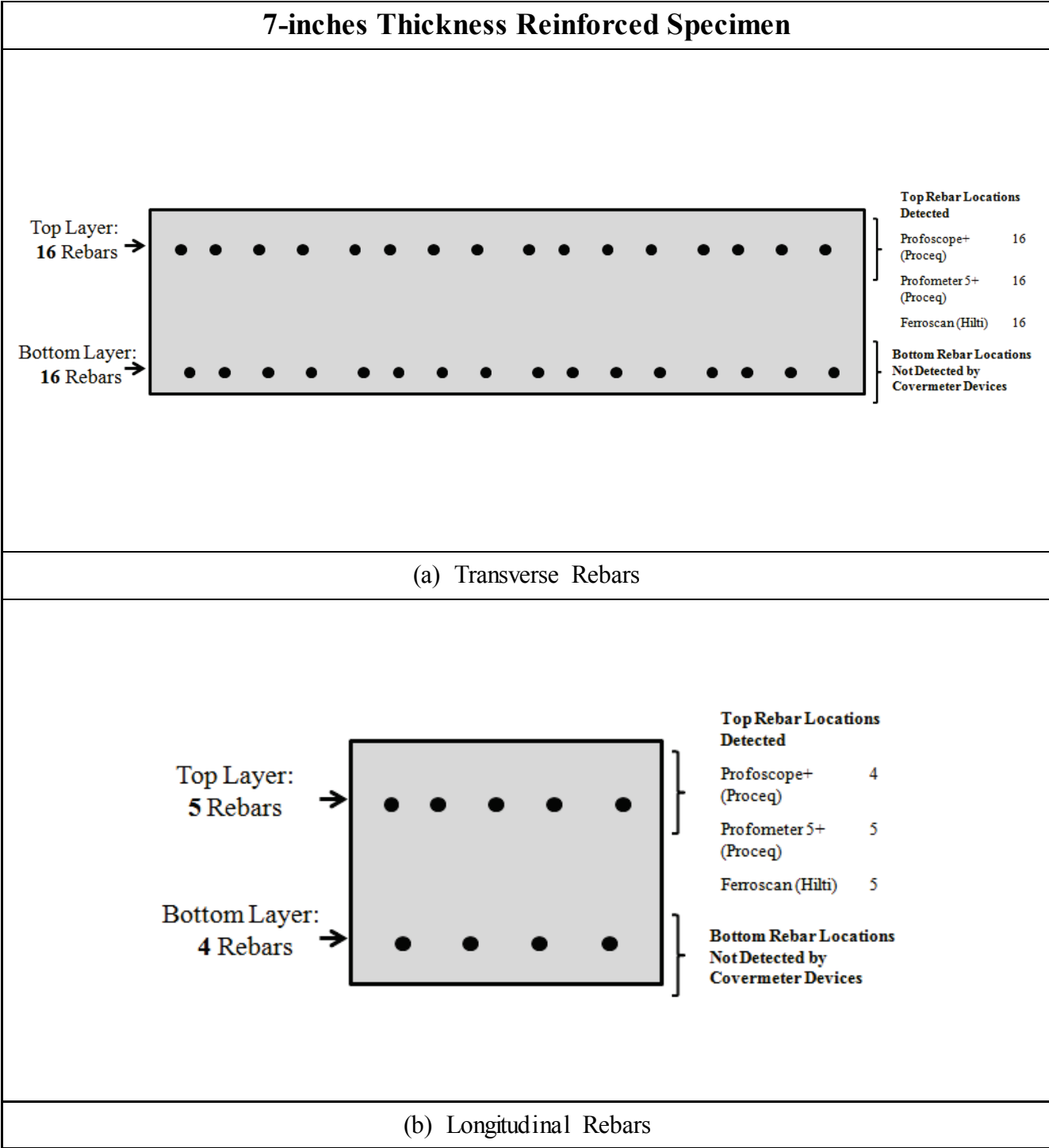

Figure 7.13. Covermeters Rebar Location Results for 7-inch Thickness Reinforced Specimen - SUMMARY.

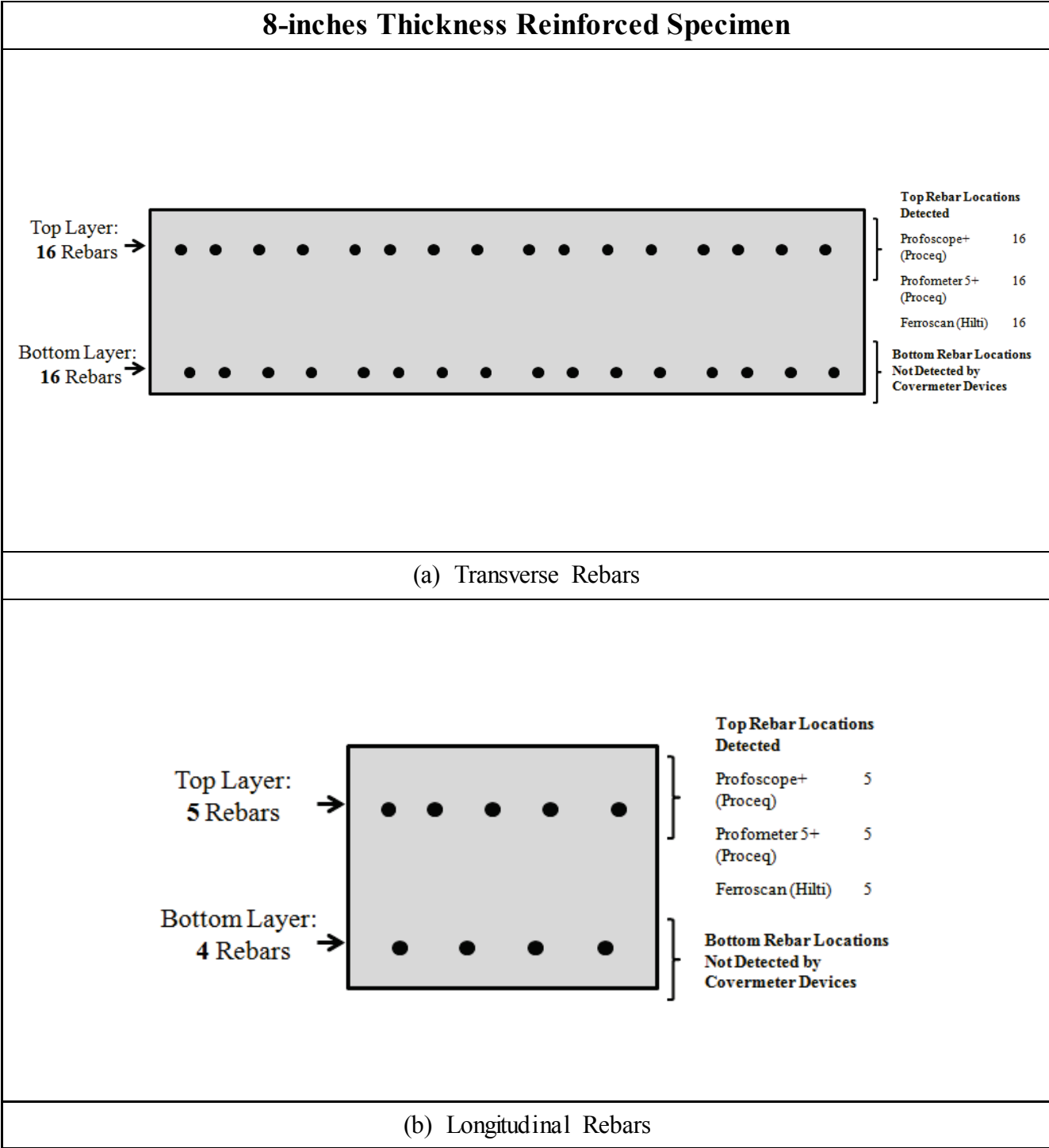
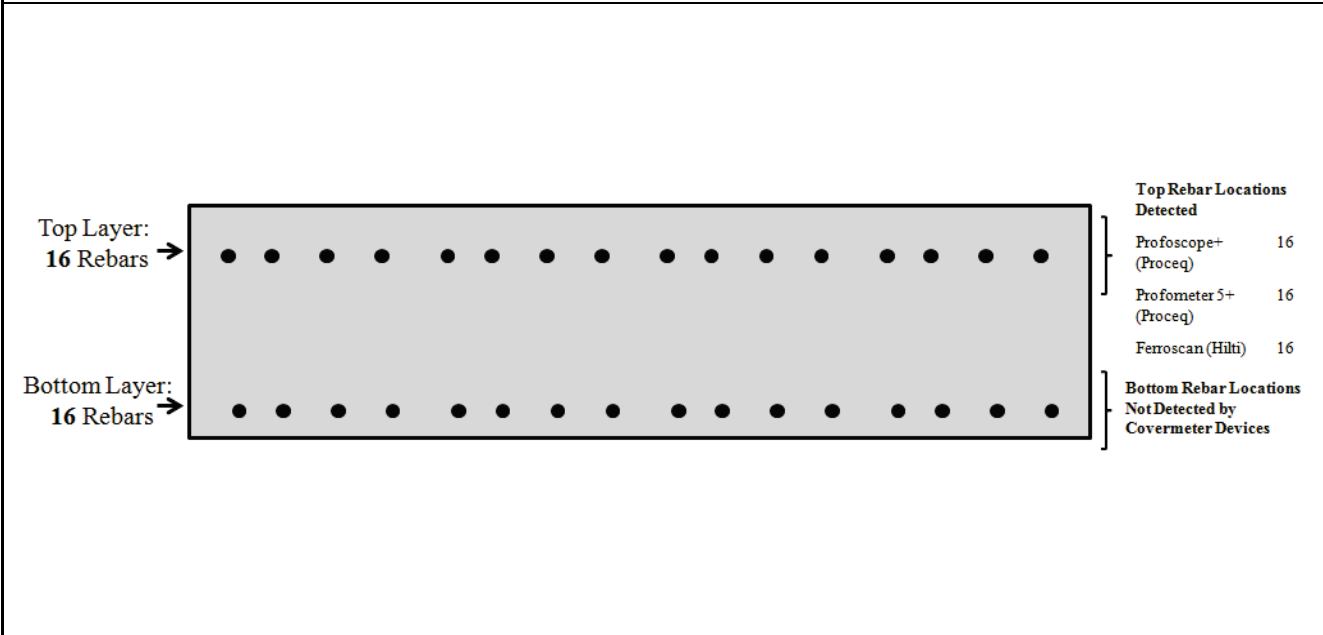
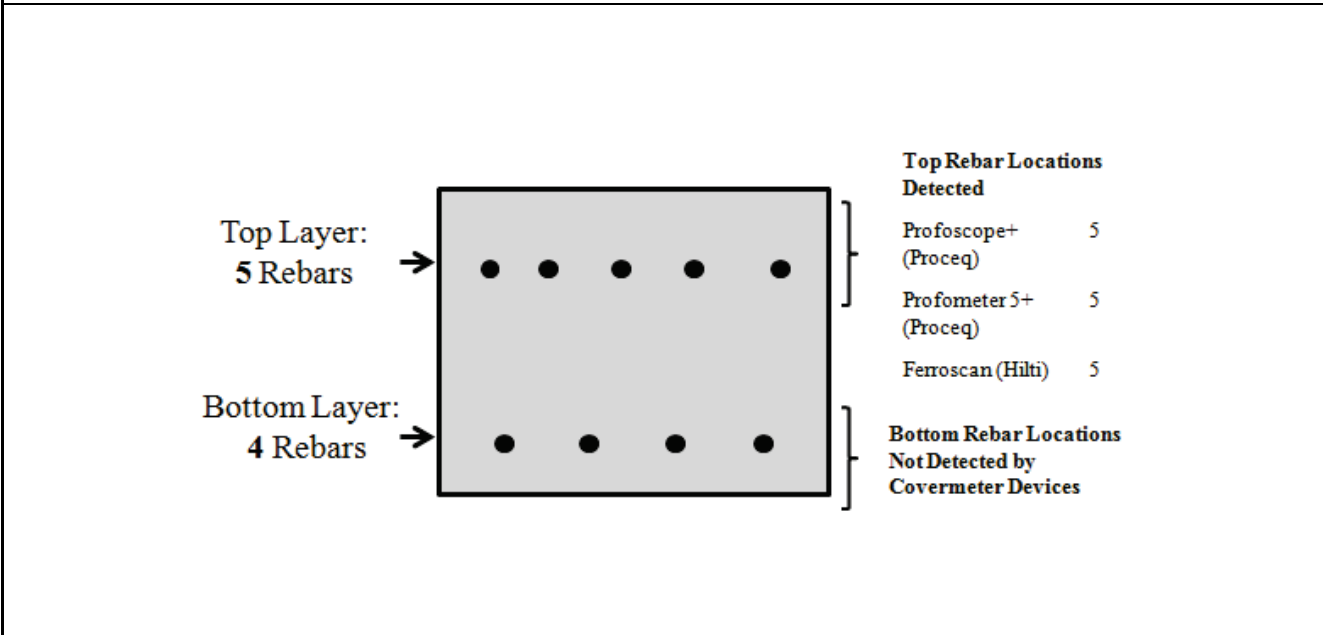

Figure 7.14. Covermeters Rebar Location Results for 8-inch Thickness Reinforced Specimen - SUMMARY.

9.5-inches Thickness Reinforced Specimen (Small Rebars)



(a) Transverse Rebars



(b) Longitudinal Rebars

Figure 7.15. Covermeters Rebar Location Results for 9.5-inch Thickness Reinforced Specimen (Small Rebars) - SUMMARY.

9.5-inches Thickness Reinforced Specimen (Big Rebars)

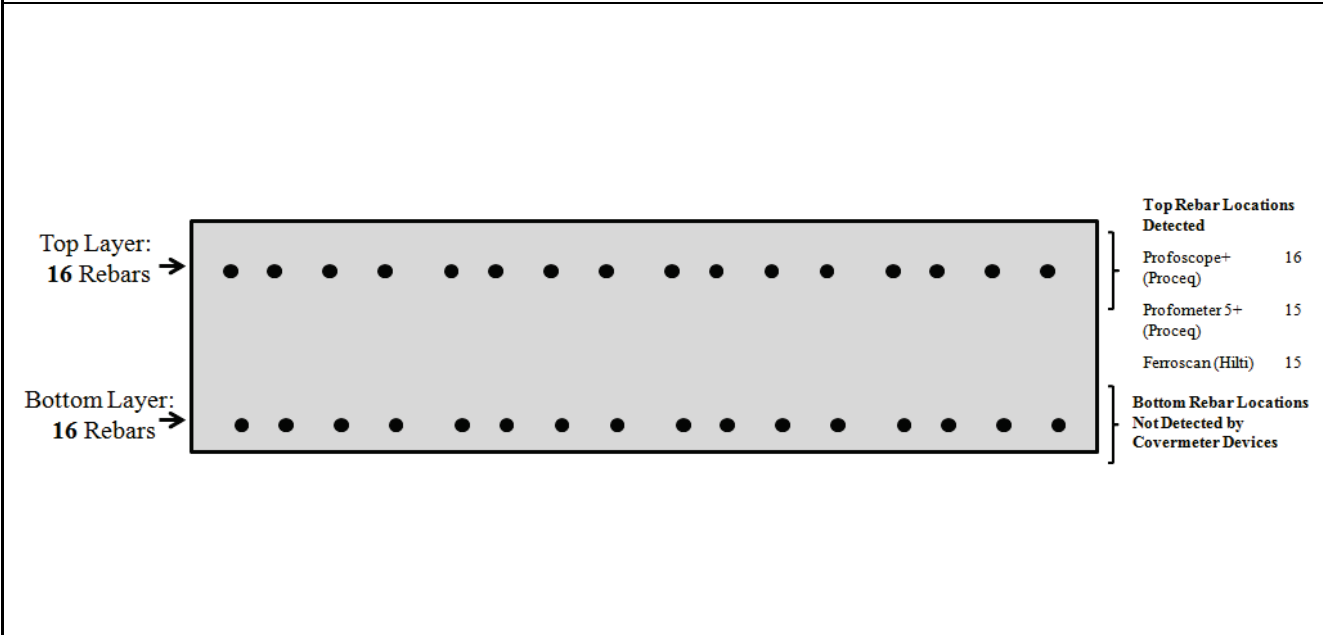

(a) Transverse Rebars

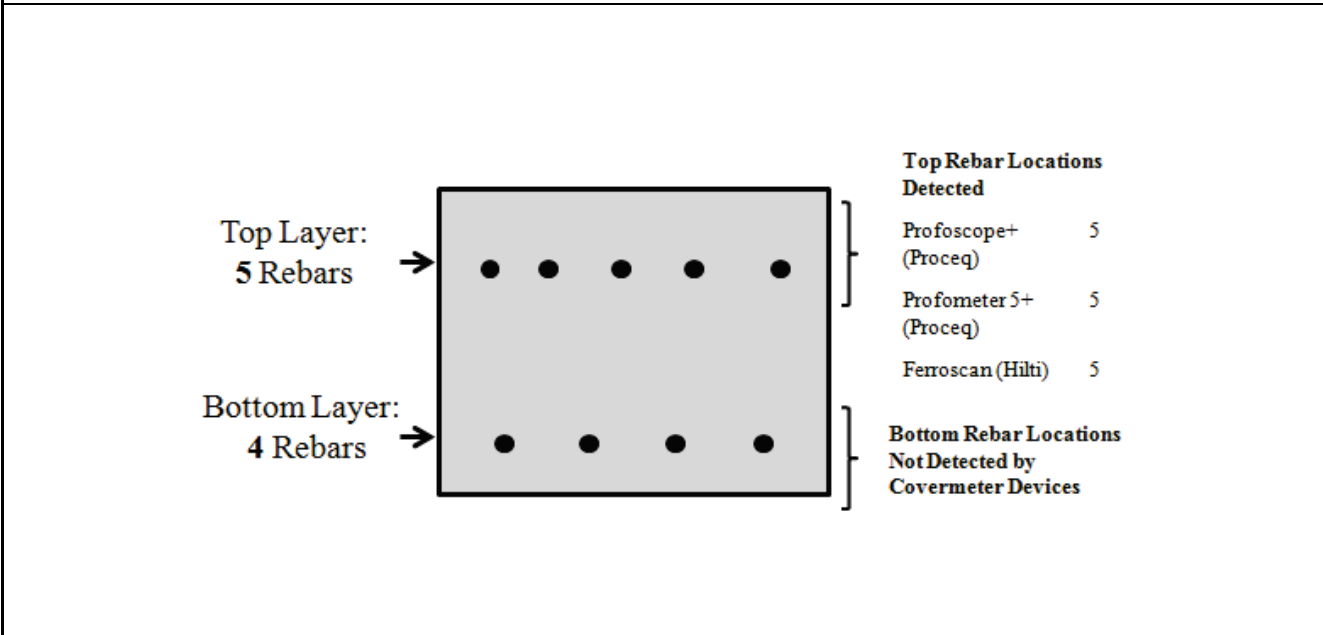

(b) Longitudinal Rebars

Figure 7.16. Covermeters Rebar Location Results for 9.5-inch Thickness Reinforced Specimen (Big Rebars) - SUMMARY.

10-inches Thickness Reinforced Specimen

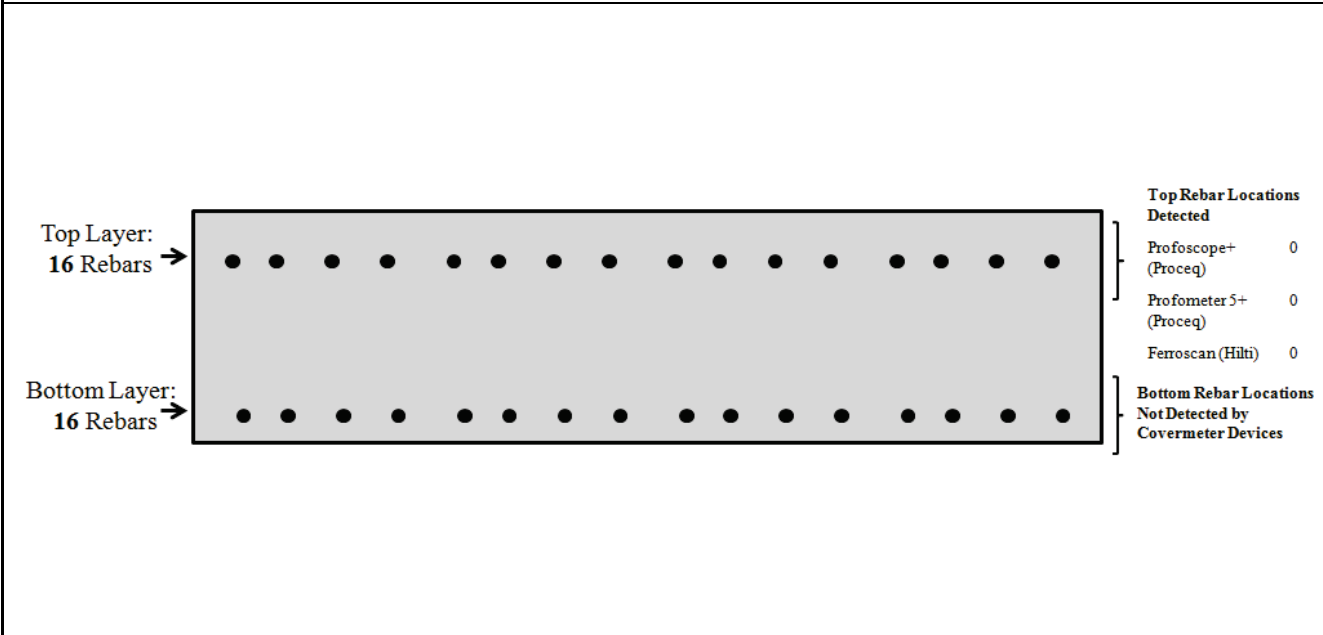

(a) Transverse Rebars

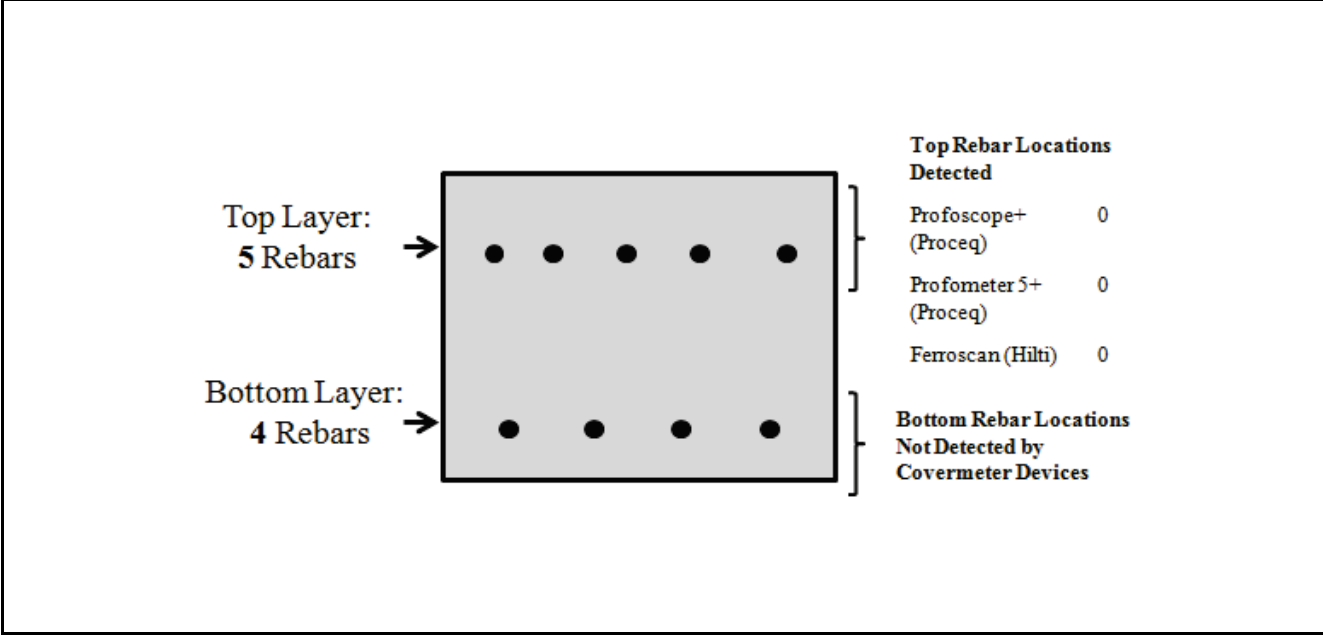

(b) Longitudinal Rebars

Figure 7.17. Covermeters Rebar Location Results for 10-inch Thickness Reinforced Specimen - SUMMARY.

These devices were only capable of detecting the first rebar layer for those reinforced concrete specimens with only 2 inches concrete coverage on the top. One of the 8-inch thick specimens was covered with a layer of 2-inch asphalt, for a final specimen thickness of 10 inches. In this particular case, covermeters were not capable of detecting the first layer of rebar, which had a concrete-asphalt coverage of 4 inches. After carefully reviewing all results from the covermeter scanning of the concrete specimens, the researchers felt that all three devices had very similar performances.

Ease of Use Comparison

Considering the brief experience TTI researchers had with scanning the concrete specimens with the three covermeters, the researchers felt all three devices had very similar mode operandi and can be fairly comparable about ease of use.

Need of Training Comparison

No considerable need of training was required for use of the covermeters. TTI researchers mainly had to follow some simple operating directions that can be found in the device technical brochure without need of external training by another operator. Considering the brief experience TTI researchers had with scanning the concrete specimens with the three covermeters, the researchers felt all three devices had very similar mode operandi and can be fairly comparable about need of training.

Price Comparison

TTI researchers suggested that anyone interested in knowing the price to purchase a particular device, he/she should contact the Company directly. Covermeter devices prices range from \$2,500 to \$19,000 approximately.

REFERENCES

1. Wimsatt A.J., Scullion T., Fernando E, Hurlebaus S., Lytton R., Zollinger D., and Walker R. "A Plan for Developing High-Speed, Nondestructive Testing Procedures for Both Design Evaluation and Construction Inspection", Strategic Highway Research Program 2, Report S2-R06-RW, Transportation Research Board, Washington D.C., 2009.
2. ACI 228.2R-98, "Nondestructive Test Methods for Evaluation of Concrete in Structures", American Concrete Institute, 1998.
3. IAEA (International Atomic Energy Agency), "Guidebook on Non-Destructive Testing of Concrete Structures", IAEA-TCS-17, ISSN 1018-5518, 2002.
4. Proceq, "High Resolution, Portable Ground Penetrating Radar (GPR): Handy Search", http://www.proceq.com/fileadmin/images/products/Concrete/gpr/PQUSA_Handy_Search_100411.pdf, retrieved on June 2012.

**APPENDIX A: LOUISIANA DEPARTMENT OF TRANSPORTATION
TEMPORARY PRECAST BARRIER - F SHAPE**

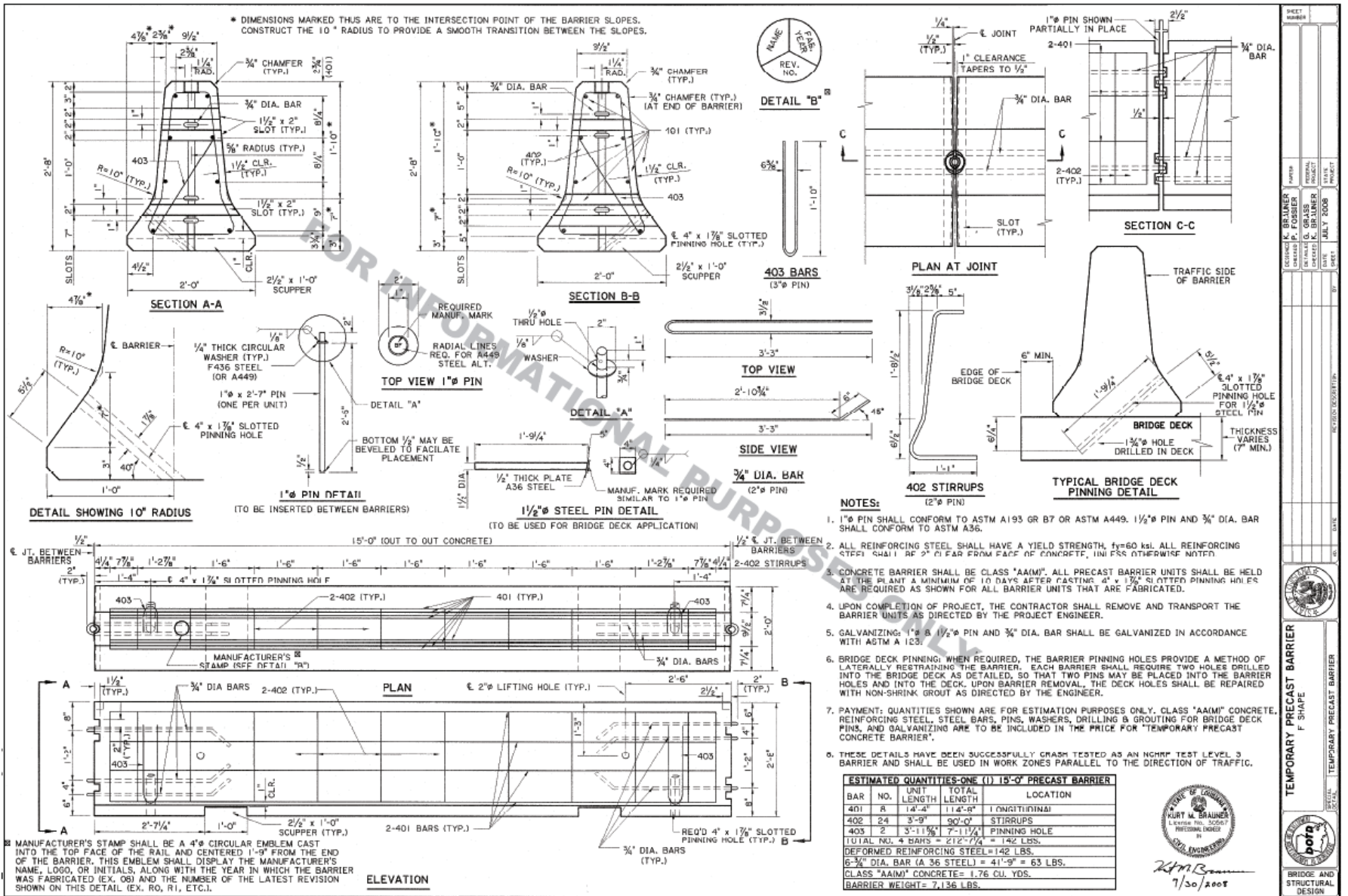

Figure A.1. Louisiana Department of Transportation Temporary Precast Barrier - F Shape.

**APPENDIX B: LOUISIANA DEPARTMENT OF TRANSPORTATION
DESIGN CRITERIA FOR CONCRETE BRIDGE DECKS**

DESIGN CRITERIA FOR CONCRETE SLAB SPANS

1. Live load moment shall be based on AASHTO 3.24.3.2 for "E". Both truck and approximate moment shall be calculated. The concrete slab shall be designed for whichever moment is greater.
2. All concrete slab spans with the clear roadway width \geq 40 ft. shall be designed for military live load.
3. Load Factor design shall be used in determining the reinforcing steel in the slab to resist the barrier rail design load only when a crash tested model can not be used.
4. Wearing surface, 19 psf.
5. Tangent deck can be used in long radius curve if difference between q does not exceed 3".

DESIGN CRITERIA FOR CONCRETE BRIDGE DECKS

For the vast majority of girder bridges, the decks are designed and built as reinforced concrete. An alternate, incorporating the use of precast stay-in-place concrete panels, which become composite with a cast-in-place portion of deck, is allowed under some circumstances. Steel stay-in-place forms may be allowed. Loads and stress analysis are as specified by AASHTO and as modified herein.

Analysis

1. The deck is designed as a continuous span over the girders.
2. The Department has chosen to satisfy both working stress and load factor requirements. For working stress design the slab will be designed as doubly reinforced concrete slab with the main reinforcement perpendicular to traffic.
3. The ultimate 28 day compressive strength for the deck concrete (Class AA) shall be 3200 psi minimum. An allowable stress of 1200 psi shall be used for the working stress method.
4. All reinforcing steel shall be grade 60 bars.
5. Since the primary stress in the deck is due to live load+impact, the creep factor applied to compression reinforcement shall be neglected.
6. A 12 psf dead load will be assumed for future wearing surface.
7. Modular Ratio: $n = 9$ will be used for the design.

8. Reinforcement shall meet the development requirements as stated in AASHTO.
9. The distribution reinforcement indicated in the charts shall be placed in the bottom of the deck.
10. Design section shall equal slab thickness less 0.50" for section loss due to tire wear.

Deck Design Details

1. Deck thickness shall vary from a minimum of 7" to a maximum of 9.5" in 0.50" increments. Optional deck panels will not be allowed as an alternate for 7" decks. Lift spans generally have 6.5" decks with 1.5" cover top and bottom.
2. A suggested pouring sequence for continuous spans is to be provided for spans over 80 ft. in length, giving the minimum rate of pour in cubic feet per hour. The necessary information should be added to the "Miscellaneous Span and Girder Details" sheet 1 of 4. The pouring sequence is based on a 4 hour set time and attempts to minimize cracks in the top of the deck. Try to break the deck into segments at contraflexure points and pour positive moment areas first unless a continuous pour across the support is possible. See Louisiana Standard Specifications article 805.03(d) and limit rate to 60 cu.yd. per hour.
3. Reinforcing steel shall have 2 in. cover at the top of the slab, and 1in. cover at the bottom of the slab.
4. Main reinforcing bars shall be #5, or #6 and be placed as near perpendicular to the girders as possible.
5. Longitudinal reinforcing bars shall be #4, unless a larger size is needed for continuity over the bents. The top plane of longitudinal steel shall have a maximum spacing of 12 in. center to center.
6. All bars greater than #4 will have a detailed maximum length of 60 ft. unless spliced. #4 bars shall be limited to 40 ft. in length for handling purposes.
7. Main reinforcing steel shall have a minimum spacing of 5 in. and not greater than the gross deck thickness plus 0.25 ".
8. Interpolation of reinforcing steel in deck design table will be allowed only between two sets of identical bar size.
9. 6 in. diameter drains should not be used directly above lower travel lanes, R.R. tracks or abutment slopes, even if revetment is present.
10. Optional deck panels are restricted from use in areas with severely skewed joints (see optional deck panel sheets for geometric limits). On bridges in curves the contractor may be allowed to use panels if he provides an independent check of his design and review of all shop drawings at no additional cost.
11. When the use of stay-in-place concrete panels will be allowed, the standard detail sheets will be incorporated into the plans and the general note sheet shall include the item "Optional Deck Details: Precast-prestressed concrete panels conforming to the optional deck detail sheets may be used at the contractor's option."

12. Stay-in-place steel forms will be allowed as an option to the contractor. The steel panels shall be galvanized in accordance to ASTM A 653, G165 (165 oz/ft² coverage each face) and not increase the dead load from the deck concrete.
13. For certain primary routes in Districts 04 and 05 (listed below), epoxy coated reinforcing steel shall be required in the top and bottom mat of steel to combat the corrosive effects of salting. In addition, the engineer should contact District 04 or 05 to verify if deicing is practiced on a particular structure in an unlisted control section. Epoxy coated reinforcement is used in the barrier rails but not in approach slabs when required in the deck.

Control Sections in Districts 04 and 05 requiring epoxy coated concrete reinforcing steel:

1-01 to 1-09	37-01 to 37-04	83-01 to 83-06
2-01 to 2-06	38-03 & 38-04 & 38-30	85-07
10-02 to 10-03	43-01 to 43-06	86-01 & 86-02
10-05, 10-06 & 10-33	44-01 to 44-03	87-02
11-01 to 11-04	45-01 & 45-03 & 45-30	98-02
15-08 & 15-31	48-01	124-03
16-01 to 16-05	49-01	156-01 to 156-03
20-06 to 20-09	51-04 to 51-08	420-01
21-01 to 21-05 & 21-30	53-06 to 53-09	427-01
23-06 & 23-09 to 23-11	67-07 to 67-09	451-01 to 451-08
25-05 to 25-08	69-02 to 69-04	451-30 & 451-31
26-08 to 26-10	70-01 to 70-07	455-07 & 455-08
27-01 to 27-06	72-01 to 72-02	809-08

The term control section refers to a section of highway and is designated by the first two digit groupings of a construction project number, for example:

Project No. 156-02-0053 ————— Control Section 156-02

14. Tension development length modification factors for epoxy reinforcing steel must be used. See AASHTO 8.25.2.3
15. When epoxy reinforcing steel is specified, separate quantities will be computed for the epoxy and non-epoxy reinforcing steel, and a separate bid item shall be included in the plans for the epoxy coated reinforcing steel.
16. The F-Shape PL-2 barrier is crash tested based on the reinforcing steel and deck thickness shown on page 5 (7). When designing deck reinforcement, the designer should verify that the deck provide at least the moment capacity at the barrier as the crash tested bridge deck.

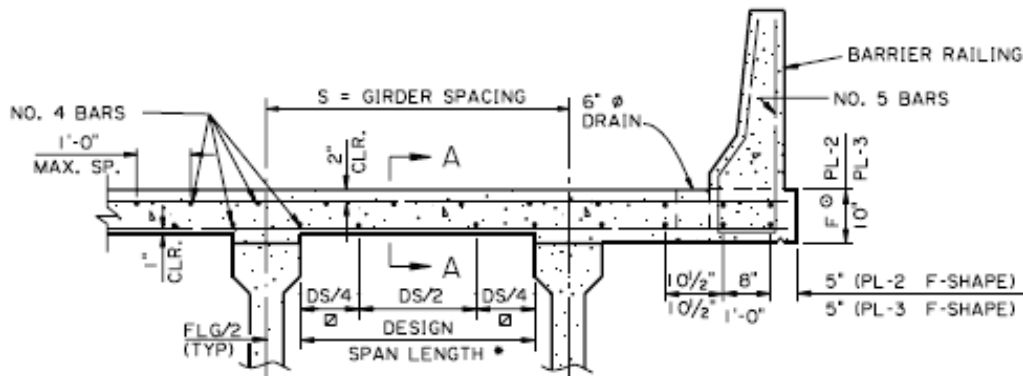

TYPICAL DECK SECTION
(PRECAST PRESTRESSED BEAM)

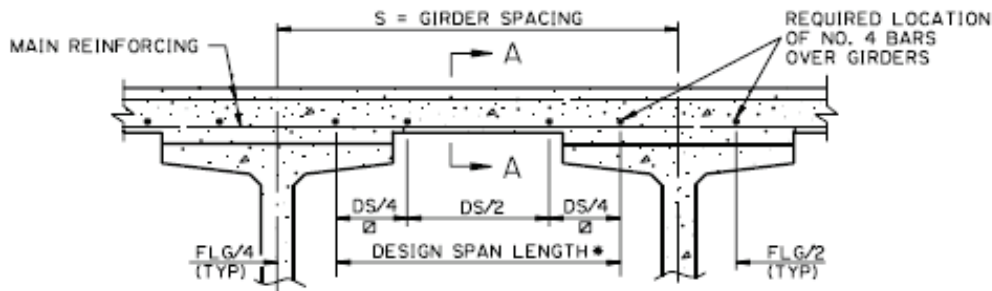

TYPE BT DECK SECTION

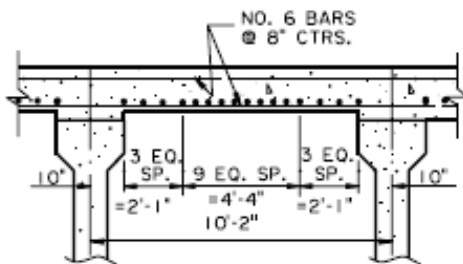

EXAMPLE SOLUTION

EXAMPLE:

GIVEN:
GIRDER SPACING=10'-2"; TYPE IV ($b_f = 1'-8"$)
DESIGN SPAN=8'-6"

SOLUTION:
FROM DECK DESIGN TABLES, THE MOST ECONOMICAL THICKNESS AND REINFORCEMENT COMBINATION IS A 8" DECK WITH STRAIGHT NO. 6 BARS AT 8" BAR SPACING. USE 10 NO. 4 BARS IN BOTTOM MIDDLE HALF OF SPAN AND THEREFORE 3 NO. 4 BARS IN EACH OUTER QUARTER.

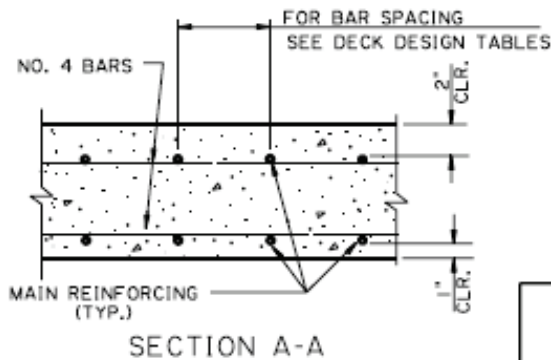

SECTION A-A

- * AASHTO 3.24.1.2
- o MINIMUM "F" (PL-2) EQUALS DECK THICKNESS PLUS 3/4" (PLUS 1" FOR 7" DECK THICKNESS). WHERE DECK THICKNESS VARIES FROM SPAN TO SPAN, SET DIMENSION "F" TO BE CONSISTENT THROUGHOUT THE BRIDGE.
- o NUMBER OF BARS WITHIN DS/4 SHALL BE EQUAL TO 1/4 THE NUMBER OF BARS REQUIRED WITHIN DS/2 FROM THE TABLE

TYPICAL SECTIONS

DECK DESIGN

NOT TO SCALE

Deck Design Tables					
Straight reinforcing steel (60 ksi), AA concrete (3500 psi)					
Slab thickness (in)	Maximum Design Span (ft)	Main Reinforcement		No of #4 Longit. Bars in bottom mid half of span	Cost \$/ sq. ft.
		Bar No.	Bar spacing (in)		
7"	8.2983	6	6.0	13	16.98
	7.9307	6	6.5	11	16.50
	7.6054	6	7.0	10	16.15
	7.8463	5	5.0	10	16.01
	7.3193	5	5.5	9	15.64
	6.6939	5	6.0	7	15.22
	6.1516	5	6.5	6	14.92
	5.6764	5	7.0	6	14.78
7.5"	10.5325	6	5.5	18	18.27
	10.0436	6	6.0	15	17.70
	9.6153	6	6.5	14	17.32
	9.0798	6	7.0	12	16.93
	8.5007	6	7.5	11	16.65
	8.9629	5	5.0	12	16.83
	8.1719	5	5.5	10	16.40
	7.4937	5	6.0	8	16.00
	6.9052	5	6.5	7	15.72
	6.3890	5	7.0	6	15.46
5.9322	5	7.5	5	15.21	
8"	12.9533	6	5.0	21	19.48
	12.3156	6	5.5	19	18.93
	11.4603	6	6.0	17	18.47
	10.6665	6	6.5	15	18.07
	9.9679	6	7.0	13	17.69
	9.3476	6	7.5	12	17.42
	8.7927	6	8.0	10	17.09
	9.8364	5	5.0	13	17.60
	8.9903	5	5.5	11	17.18
	8.2642	5	6.0	9	16.80
	7.6332	5	6.5	8	16.53
	7.0794	5	7.0	7	16.28
	6.5889	5	7.5	6	16.04
6.1511	5	8.0	5	15.81	

Deck Design Table					
Straight reinforcing steel (60 ksi), AA concrete (3500 psi)					
Slab thickness (in)	Maximum Design Span (ft)	Main Reinforcement		No. of #4 Longit.	Cost \$ / sq. ft.
		Bar No.	Bar spacing (in)	Bars in bottom mid half of span	
8.5"	14.4746	6	5.0	23	20.22
	13.3569	6	5.5	20	19.66
	12.3938	6	6.0	18	19.22
	11.5540	6	6.5	16	18.82
	10.8142	6	7.0	14	18.46
	10.1569	6	7.5	13	18.19
	9.5683	6	8.0	11	17.86
	9.0379	6	8.5	10	17.63
	10.6679	5	5.0	14	18.36
	9.7721	5	5.5	11	17.88
	9.0022	5	6.0	10	17.58
	8.3327	5	6.5	8	17.23
	7.7444	5	7.0	7	16.98
	7.2229	5	7.5	6	16.75
	6.7571	5	8.0	6	16.64
6.3382	5	8.5	5	16.42	
9.0"	15.4557	6	5.0	23	20.92
	14.2855	6	5.5	21	20.41
	13.2761	6	6.0	18	19.92
	12.3950	6	6.5	16	19.52
	11.6181	6	7.0	15	19.22
	10.9272	6	7.5	13	18.89
	10.3082	6	8.0	12	18.65
	9.7499	6	8.5	11	18.42
	9.2434	6	9.0	10	18.21
	11.4571	5	5.0	14	19.06
	10.5163	5	5.5	12	18.66
	9.7069	5	6.0	10	18.29
	9.0023	5	6.5	9	18.03
	8.3825	5	7.0	8	17.79
	7.8326	5	7.5	7	17.57
	7.3409	5	8.0	6	17.35
	6.8985	5	8.5	6	17.25
6.4980	5	9.0	5	17.06	

Deck Design Table					
Straight reinforcing steel (60 ksi), AA concrete (3500 psi)					
Slab thickness (in)	Maximum Design Span (ft)	Main Reinforcing		No of #4 Longit. Bars in bottom mid half of span	Cost \$ / sq. ft.
		Bar No.	Bar spacing (in)		
9.5"	16.3765	6	5.0	24	21.67
	15.1593	6	5.5	21	21.12
	14.1084	6	6.0	19	20.68
	13.1903	6	6.5	17	20.29
	12.3801	6	7.0	15	19.93
	11.6589	6	7.5	14	19.67
	11.0123	6	8.0	13	19.43
	10.4287	6	8.5	11	19.13
	9.8989	6	9.0	10	18.92
	9.4155	6	9.5	9	18.73
	12.2048	5	5.0	15	19.84
	11.2234	5	5.5	13	19.44
	10.3782	5	6.0	11	19.09
	9.6416	5	6.5	10	18.83
	8.9931	5	7.0	8	18.51
	8.4172	5	7.5	7	18.29
	7.9020	5	8.0	7	18.17
	7.4379	5	8.5	6	17.98
	7.0174	5	9.0	5	17.78
	6.6346	5	9.5	5	17.70

1. Slab thickness shown above includes 0.50" of wearing surface (see page 5 (44))
2. Bar spacing is measured center to center
3. Minimum main bar spacing shall be 5".
4. Design Load includes a future wearing surface of 12 psf.
5. Longitudinal bars in the bottom outer fourth of span = bars in mid half/4.
6. Longitudinal bars in the top shall be at 12" max. centers.
7. Cost based on \$500 /cu. yd. Class AA Concrete & \$0.75 / lb. Reinforcing Steel

**APPENDIX C: STUDY OF THE POSSIBLE CONCRETE CURING TIME
EFFECT ON GPR DEVICES REBAR LOCATOR CAPABILITIES**

A total of two identical reinforced specimens were built at the Roadside Safety & Physical Security Division at TTI for testing the influence of concrete curing time on the rebar locator capabilities of the ground penetrating radar devices selected. The concrete for the first specimen was poured on December 20, 2011. The concrete for the second specimen was poured on January 02, 2012.

CONCRETE SPECIMENS DESIGN - CONCRETE CURING EFFECT

The specimens characteristics were the following:

- Reinforced specimens are 3 ft long and 3 ft wide;
- Total height of both decks is 8 inches;
- Two rebar layers are included in each specimen: a first (top) layer, with 2 inches concrete coverage from the top and a second (bottom) layer with 1 inch concrete coverage from the bottom;
- All rebars have a 5/8 inch diameter;
- On one side, spacing between top rebars is 8 inches, and spacing between bottom rebars varies between 9 and 11 inches;
- On the other side, spacing between top rebars is 6 inches, and spacing between bottom rebars is 7 inches;
- Concrete blocks will be tested when supported by the ground.

Figure C.1 reports the detailed drawings for the concrete specimens. Testing plan for GPR devices rebar locator capabilities evaluation with different concrete pouring time is reported below. Specimens were tested in two different dates: January 18, 2012 and February 03, 2012.

On January 18, tests were performed with use of the following GPR devices: SS MiniHR Unit (GSSI), PS1000 X-Scan (Hilti), Handy Search (JRC/Proceq), and Aladdin System (IDS/Olson Instruments). On February 03, tests were performed with use of the following devices: SS MiniHR Unit (GSSI), PS1000 X-Scan (Hilti), and Handy Search (JRC/Proceq). On this date, the Aladdin System from IDS/Olson Instruments was not available for testing since the device had to be previously sent back to the Company under request of their representatives.

Tests of the specimens were performed on the same day with use of all devices to allow for use of each device under the same concrete curing time conditions. On January 18, 2012, specimen #1 was 29 days old, and specimen #2 was 16 days old. On February 03, 2012, specimen #1 was 45 days old, and specimen #2 was 32 days old.

Tests were performed by a TTI representative at no presence of the Companies to allow discrete use of all devices on the same day. Files saved from the scanning process with the GPR device were sent to the corresponding Company representatives who evaluated and post-processed the files and returned identified rebar position and concrete coverage data to TTI for completion of test evaluation. Sometimes, the rebar location data obtained by the GPR device appeared to be consistently off of a certain value with respect to the actual position of the rebars. The consistent displacement was most probably due to a different positioning of the GPR device at the beginning of the specimen scanning. Thus, the TTI representative reviewed each single case to evaluate if the

difference between the rebar real position and the identified location by the GPR device was in fact due to a misplacement of the device at the beginning of the scanning. In that case, results were adjusted according to the consistent displacement. The TTI representative felt confident in performing this adjustment since the scope of these testing was not to evaluate accuracy of the devices, but instead to verify possible effects of the concrete curing time on the GPRs capability to identify rebars.

Figure C.2 shows results obtained with GPR scanning performed on slab #1 on January 18, 2012, when the concrete curing time was 29 days. Screenshots obtained from the GPR devices after slab #1 scanning on January 18 are reported in Figures C3 (for transverse rebars side) and C4 (for longitudinal rebars side).

Figure C.5 shows results obtained with GPR scanning performed on slab #2 on January 18, 2012, when the concrete curing time was 16 days. Screenshots obtained from the GPR devices after slab #2 scanning on January 18 are reported in Figures C6 (for transverse rebars side) and C7 (for longitudinal rebars side).

Figure C.8 shows results obtained with GPR scanning performed on slab #1 on February 03, 2012, when the concrete curing time was 45 days. Screenshots obtained from the GPR devices after slab #1 scanning on February 03 are reported in Figures C9 (for transverse rebars side) and C10 (for longitudinal rebars side).

Figure C.11 shows results obtained with GPR scanning performed on slab #2 on February 03, 2012, when the concrete curing time was 32 days. Screenshots obtained from the GPR devices after slab #2 scanning on February 03 are reported in Figures C12 (for transverse rebars side) and C13 (for longitudinal rebars side).

Data collected suggested that the employed GPR devices are capable of detecting 5/8" diameter rebars with 6.375 inches of concrete coverage in a concrete specimen with curing time of 16 days only. Results, however, are restricted to the concrete specimen design that was chosen was performance of these testing. TTI researchers do not guarantee similar GPR capabilities for testing performed on reinforced concrete specimens with different rebar sizes and/or rebar spacing.

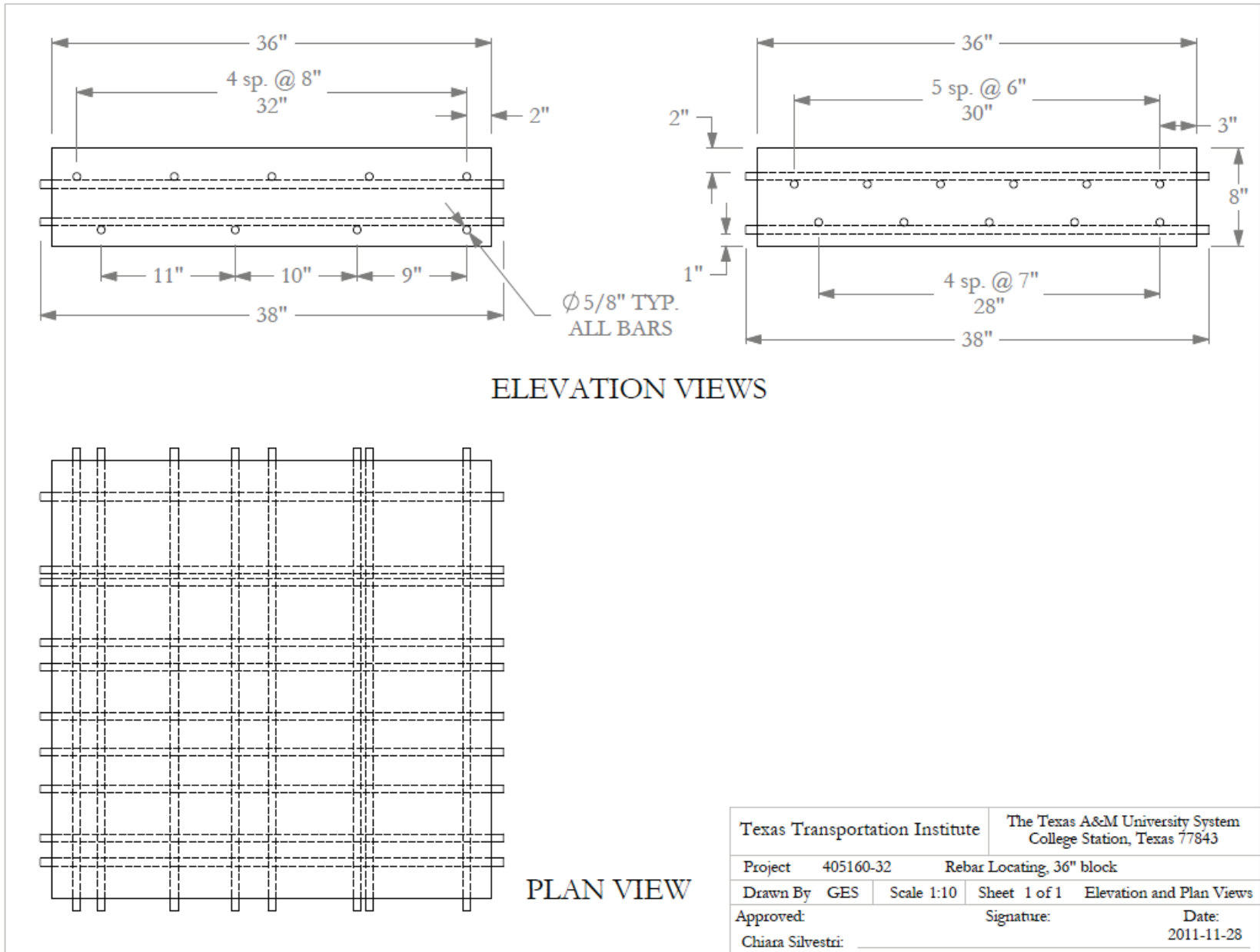

Figure C.1. Reinforced Concrete Specimens.

Testing Plan for Rebar Location with Ground Penetrating Radars - Concrete Curing Influence

Devices Tested:.....Ground Penetrating Radar (GPR)

Total Specimens to Be Tested:...2

Scope of the Test:.....1) Evaluate possible influence of concrete curing time on rebar locator capabilities of the devices. Locate **First and Second** Layer of Longitudinal and Transverse Rebars (for each rebar, identify the distance from a specimen corner which is considered a reference point)

.....2) Identify Rebar Concrete Coverage (inches)

Directions for Test Completion

- 1) All specimens are tested when **laying on ground**;
- 2) A reference point is identified for each concrete specimen;
- 3) A TTI representative followed instructions to perform scanning of the specimen with the GPR device in both longitudinal and transverse directions;
- 4) Files saved from the scanning process with use of a particular GPR device were sent via email to the corresponding Company representative;
- 5) Each Company representative evaluated the files to assure data collection was performed correctly and post-processed the data received;
- 6) For each concrete specimen, post-processed position and concrete coverage for the identified top and bottom rebars were reported by the Companies representatives.

RESULTS - CONCRETE CURING EFFECT

Test of January 18, 2012

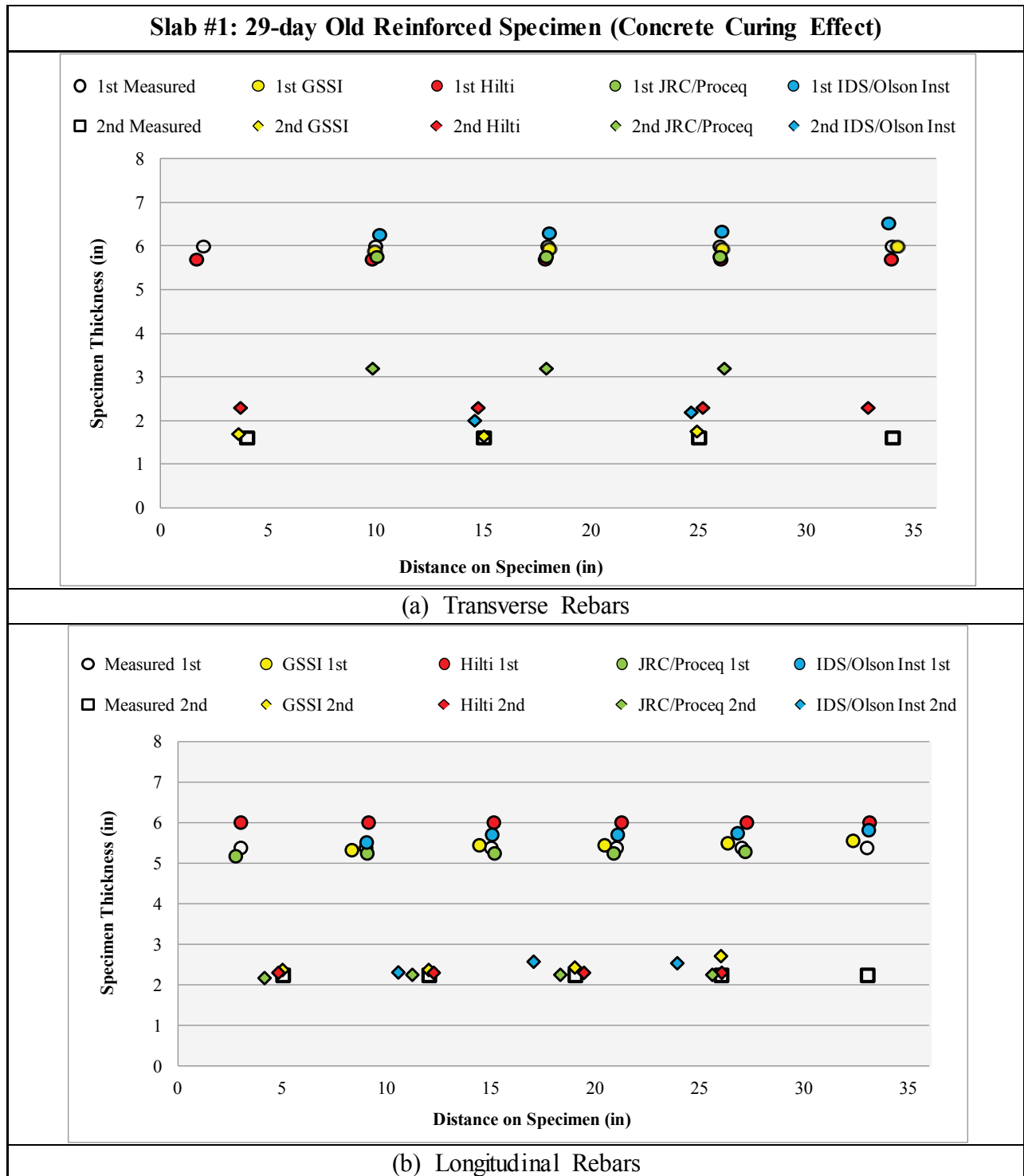
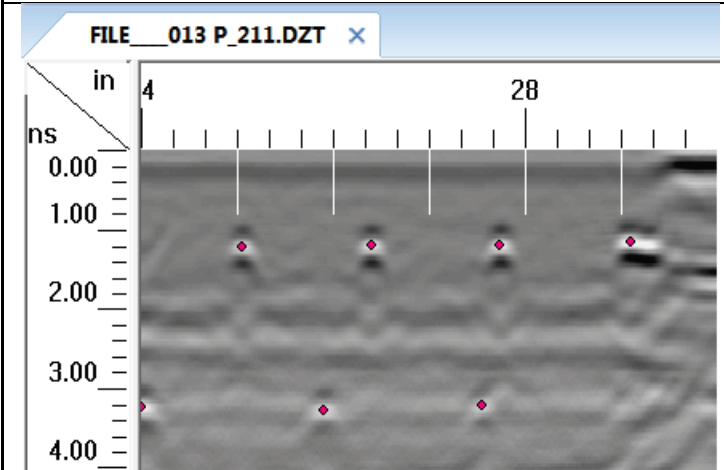
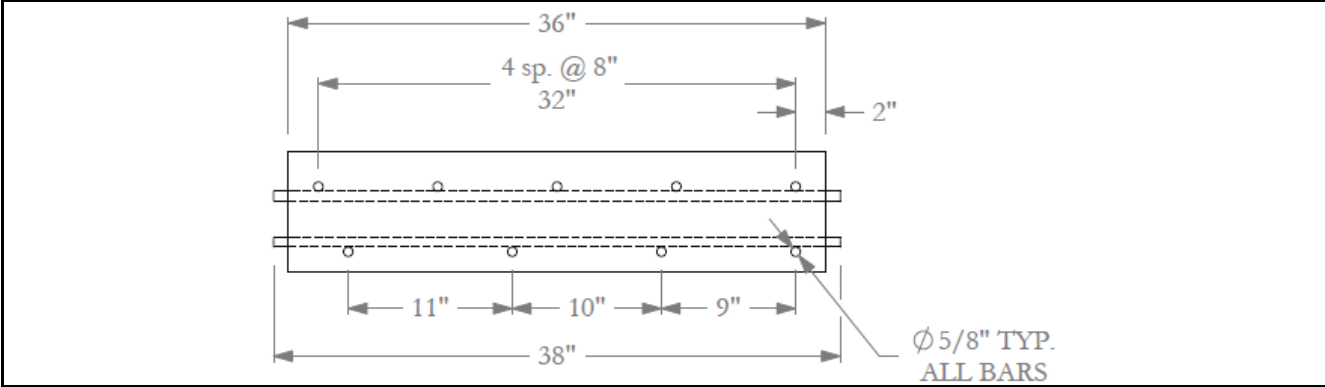
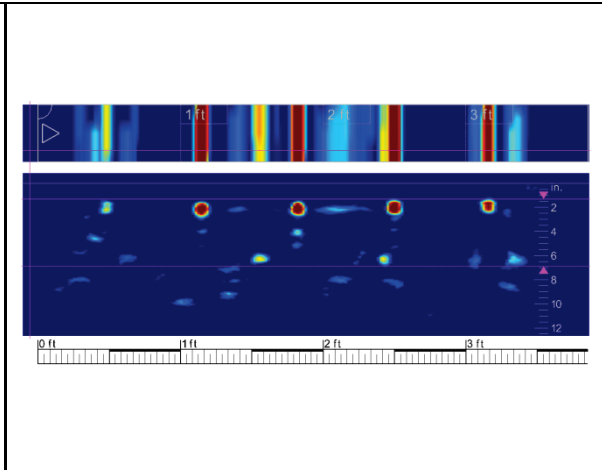

Figure C.2. GPR Results for Slab #1 - 8-inch Thickness Reinforced Specimen (Concrete Curing Effect) - Summary for January 18, 2012 Testing.



SS MiniHR Unit (GSSI)



PS1000 X-Scan (Hilti)

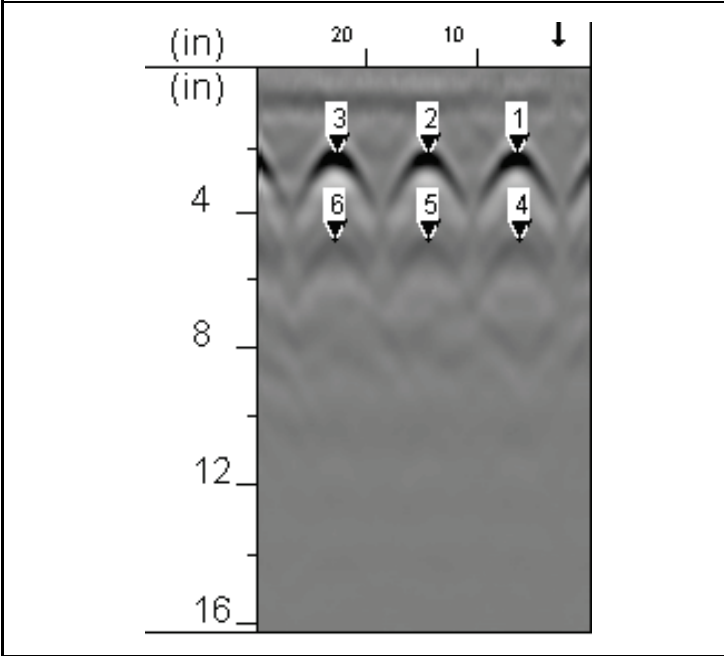

Handy Search (JRC/Proceq)

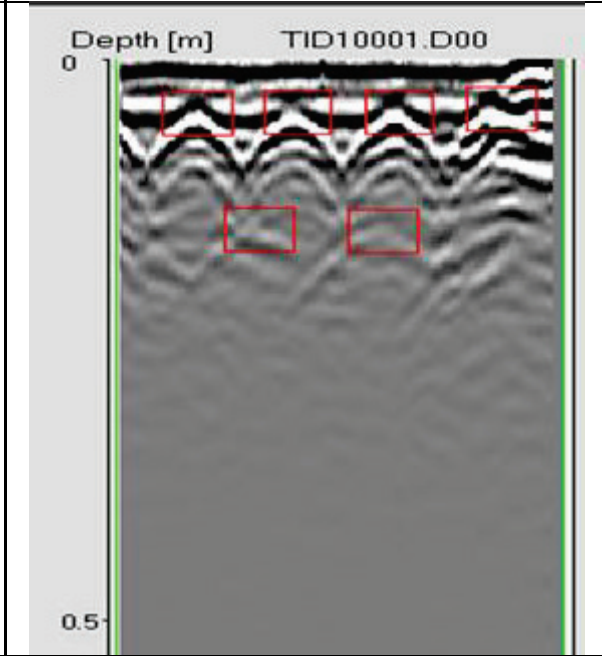

Aladdin System (IDS/Olson Instruments)

Figure C.3. GPR Scanning Images for Transverse Rebars for Slab #1 taken on January 18, 2012 - Summary for 29-day Old Reinforced Specimen.

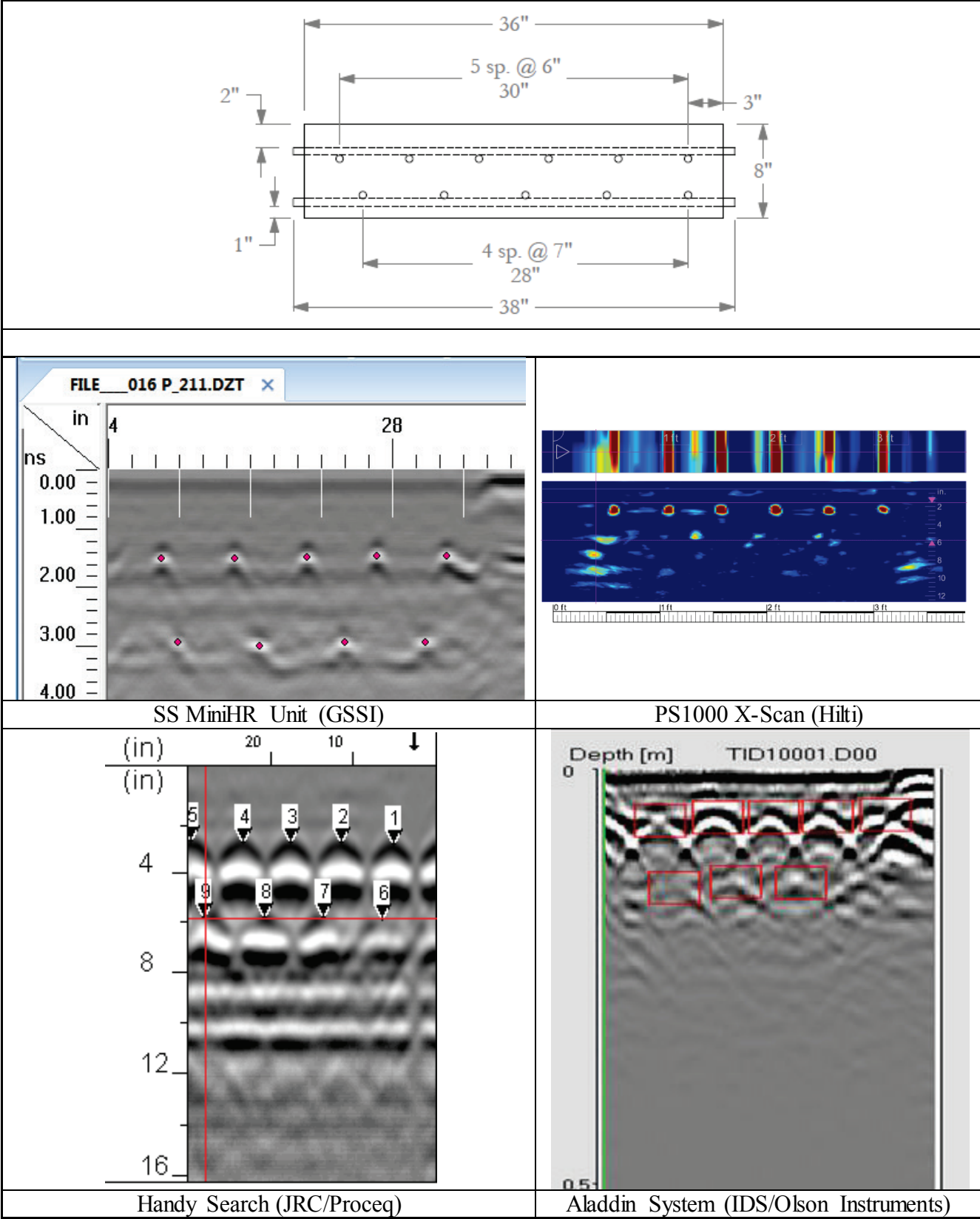
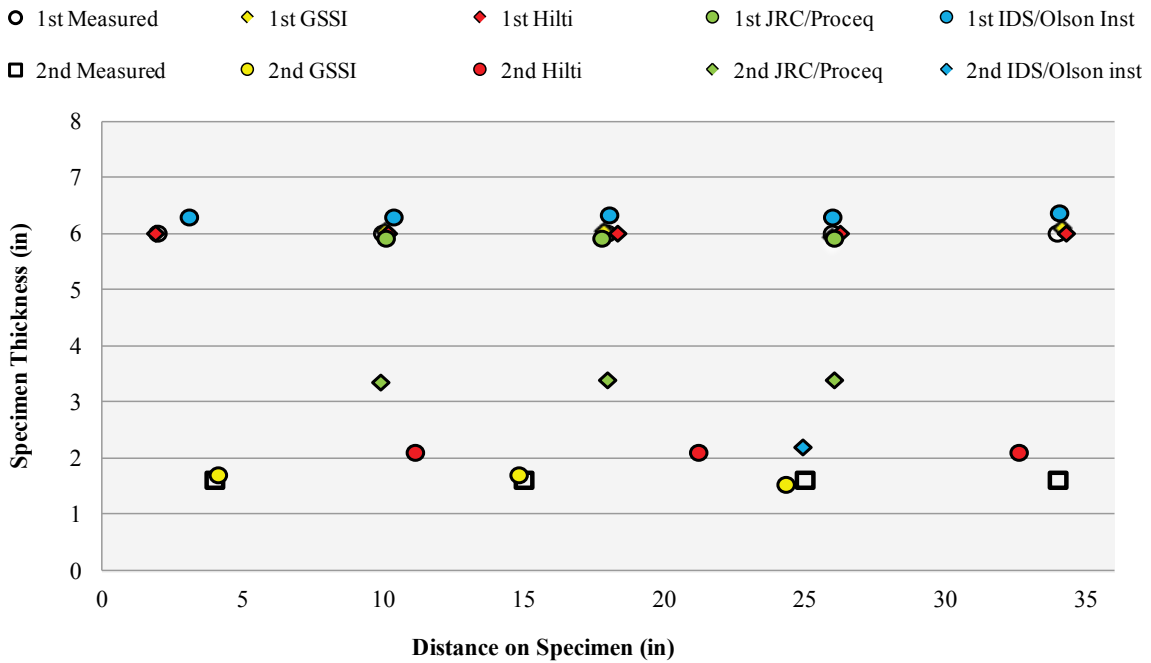
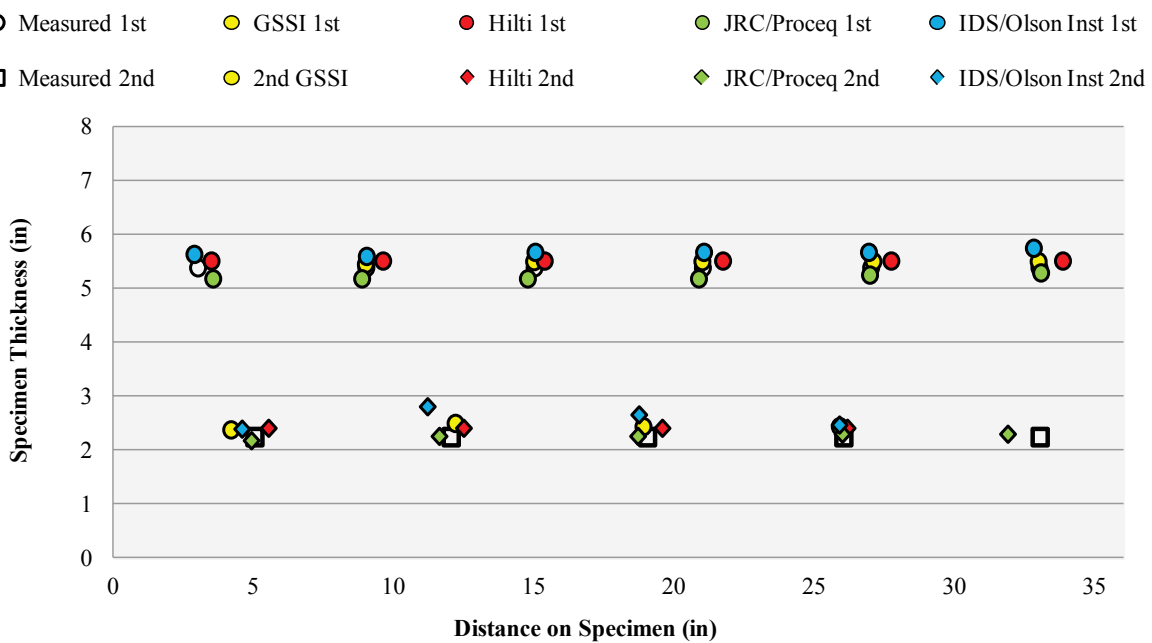

Figure C.4. GPR Scanning Images for Longitudinal Rebars for Slab #1 taken on January 18, 2012 - Summary for 29-day Old Reinforced Specimen.

Slab #2: 16-day Old Reinforced Specimen (Concrete Curing Effect)



(a) Transverse Rebars



(b) Longitudinal Rebars

Figure C.5. GPR Results for Slab #2 - 8-inch Thickness Reinforced Specimen (Concrete Curing Effect) - Summary for January 18, 2012 Testing.

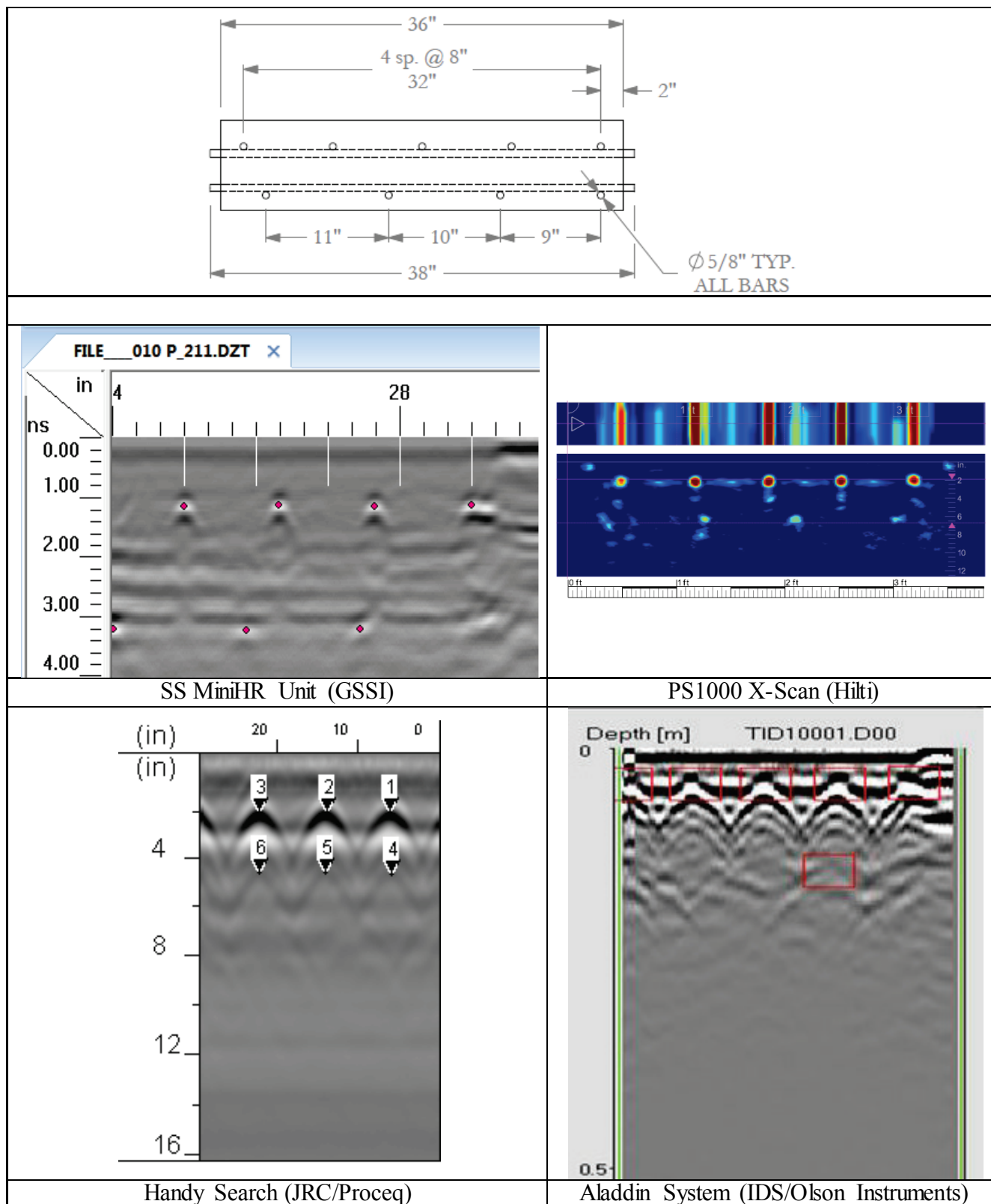

Figure C.6. GPR Scanning Images for Transverse Rebars for Slab #2 taken on January 18, 2012 - Summary for 16-day Old Reinforced Specimen.

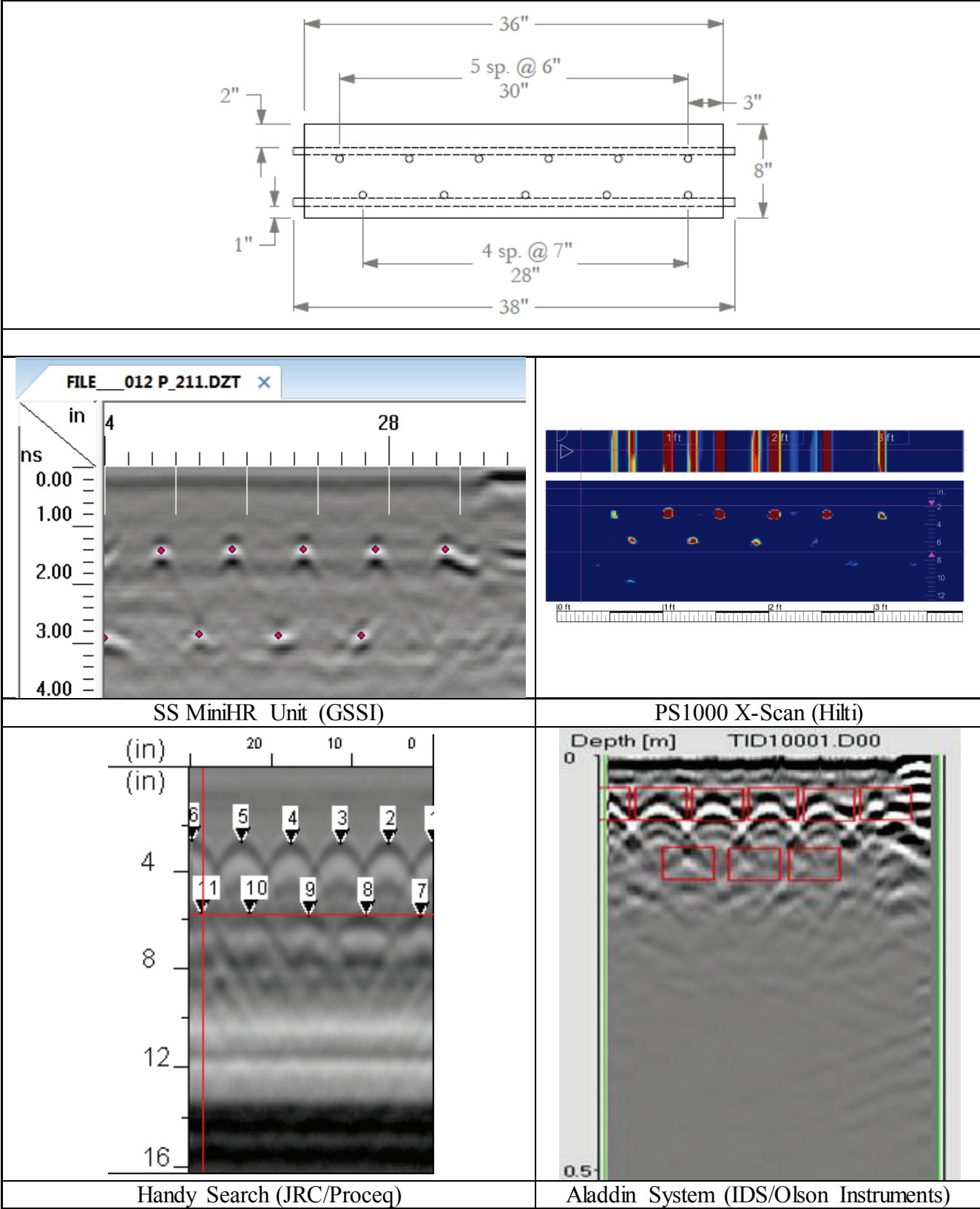

Figure C.7. GPR Scanning Images for Longitudinal Rebars for Slab #2 taken on January 18, 2012 - Summary for 16-day Old Reinforced Specimen.

Test of February 03, 2012

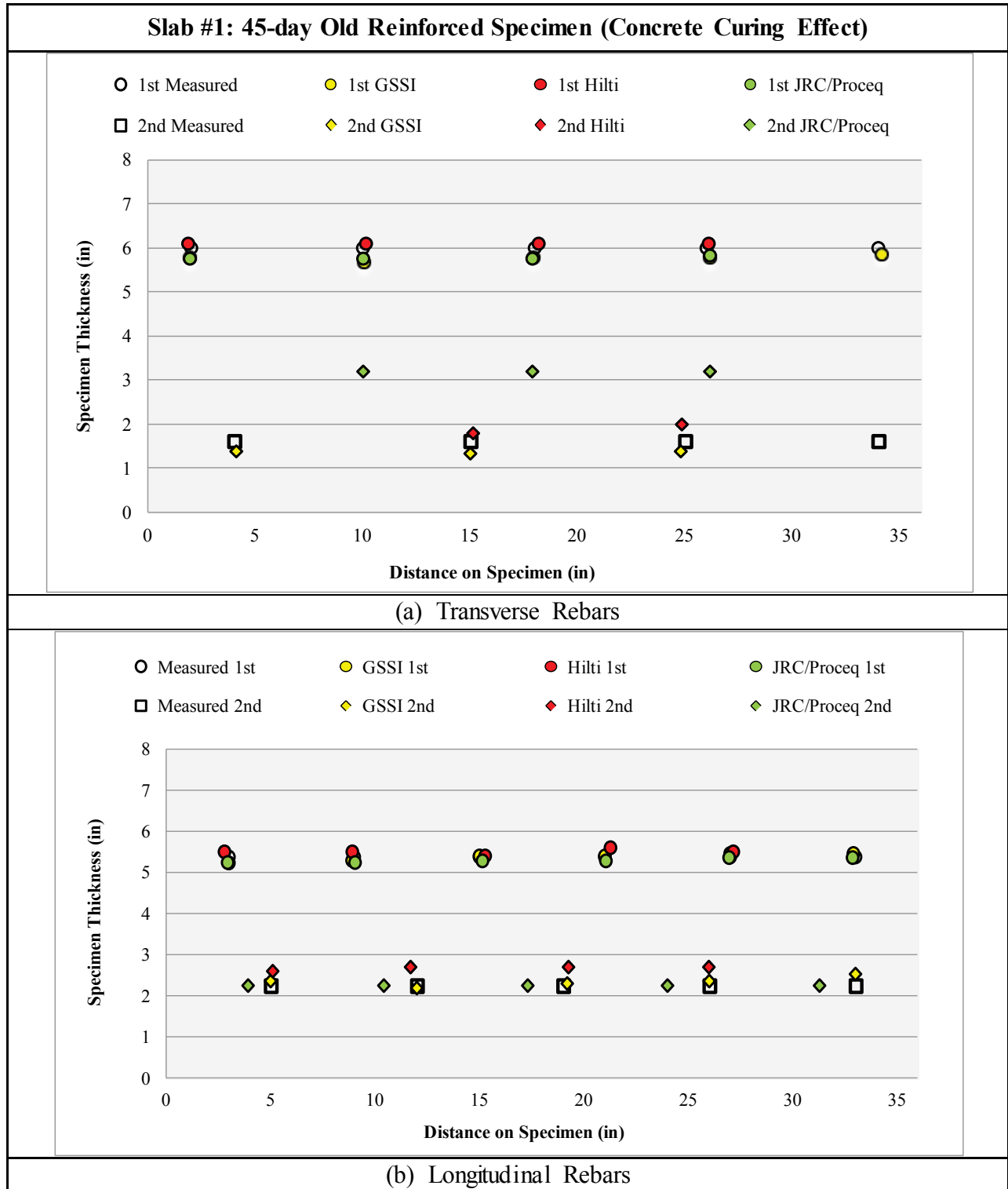
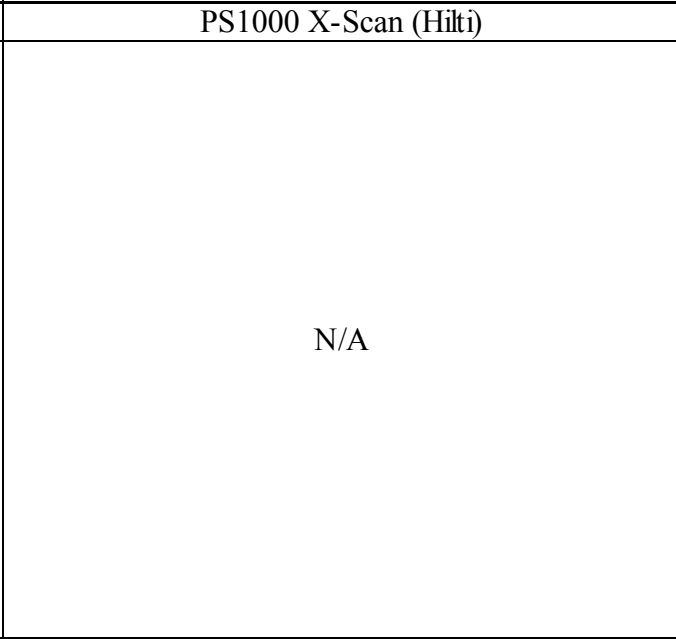
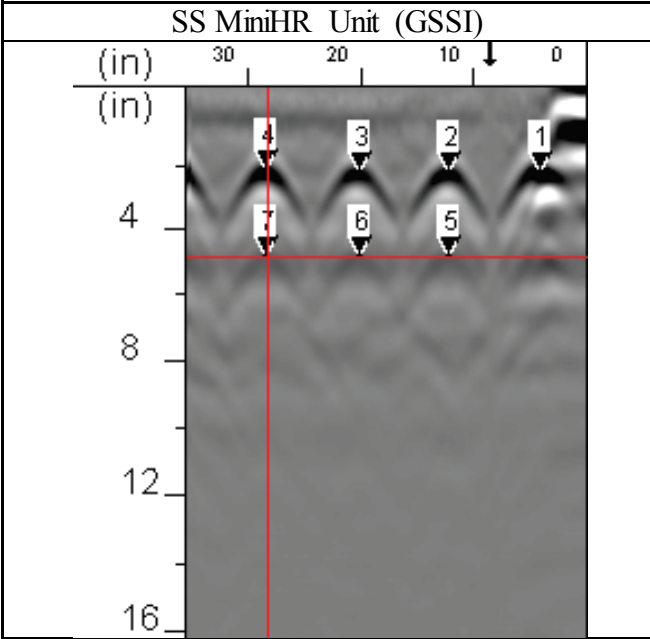
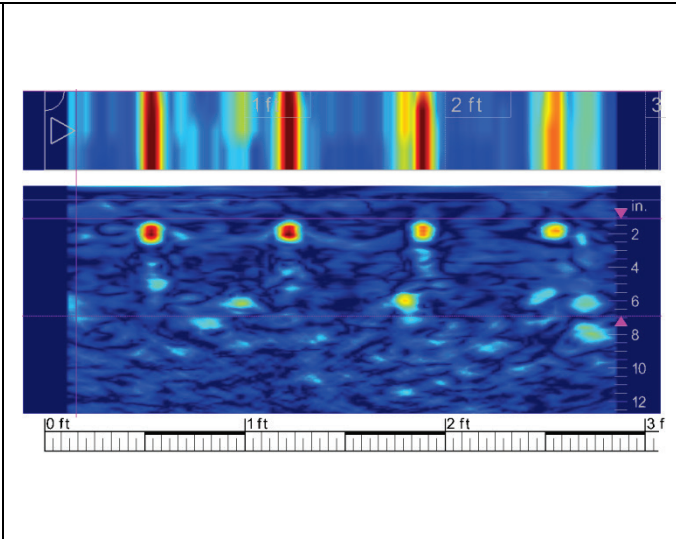
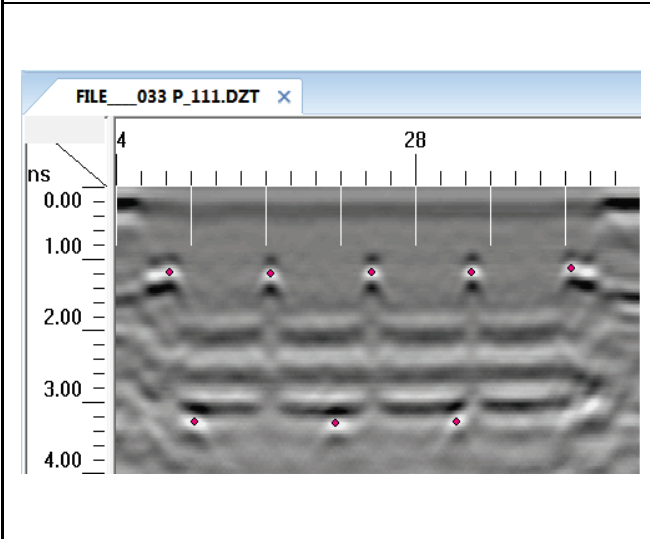
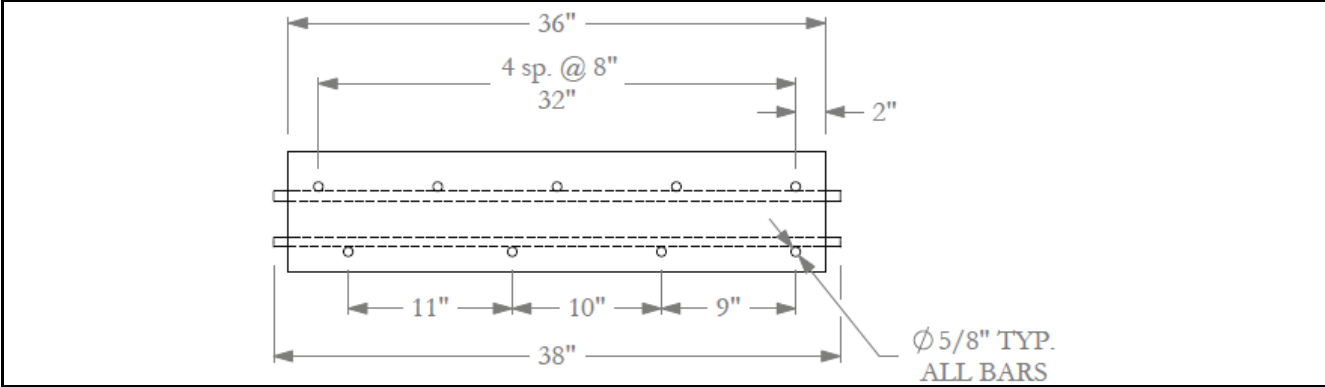
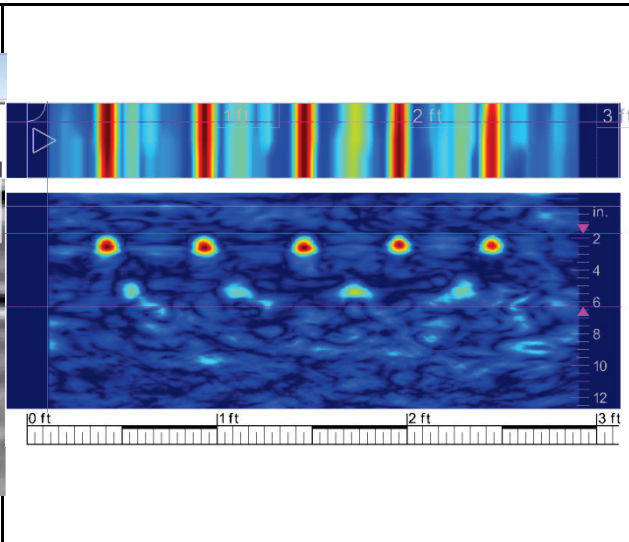
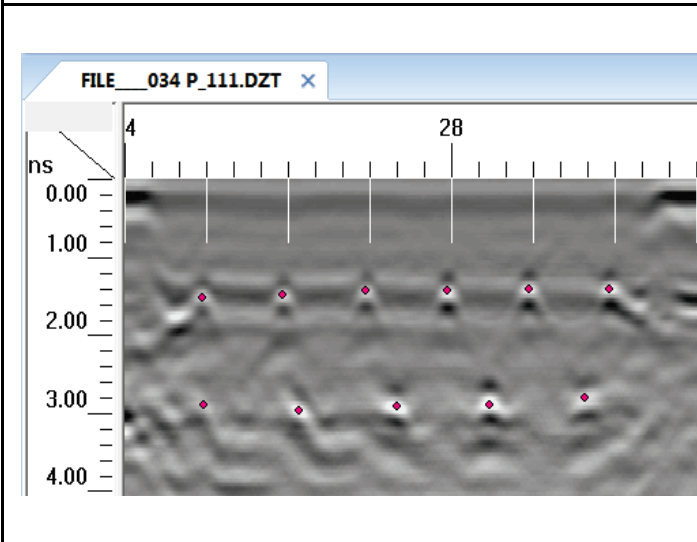
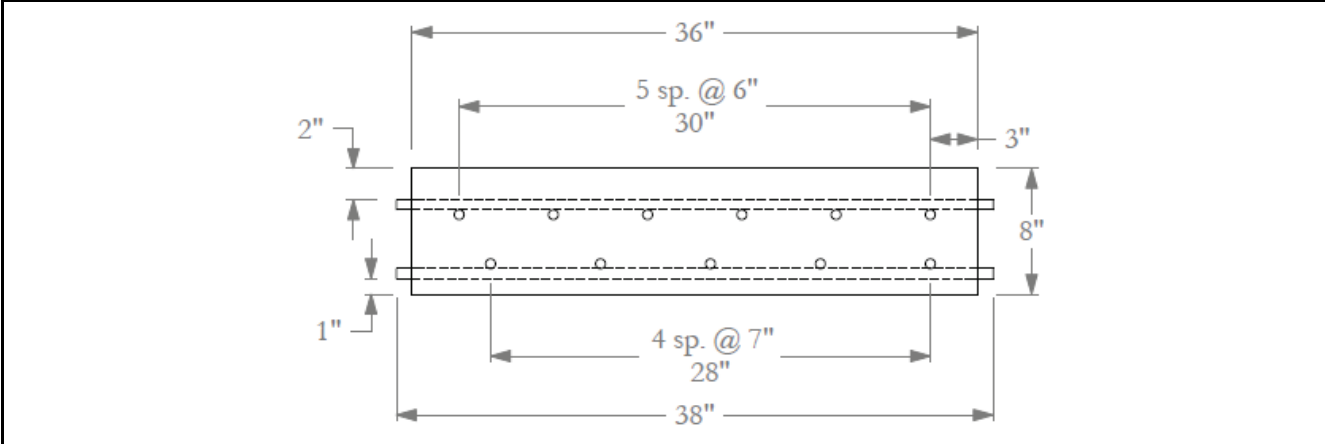

Figure C.8. GPR Results for Slab #1 - 8-inch Thickness Reinforced Specimen (Concrete Curing Effect) - Summary for February 03, 2012 Testing.



Handy Search (JRC/Proceq) Aladdin System (IDS/Olson Instruments)

Figure C.9. GPR Scanning Images for Transverse Rebars for Slab #1 taken on February 03, 2012 - Summary for 45-day Old Reinforced Specimen.



SS MiniHR Unit (GSSI)

PS1000 X-Scan (Hilti)

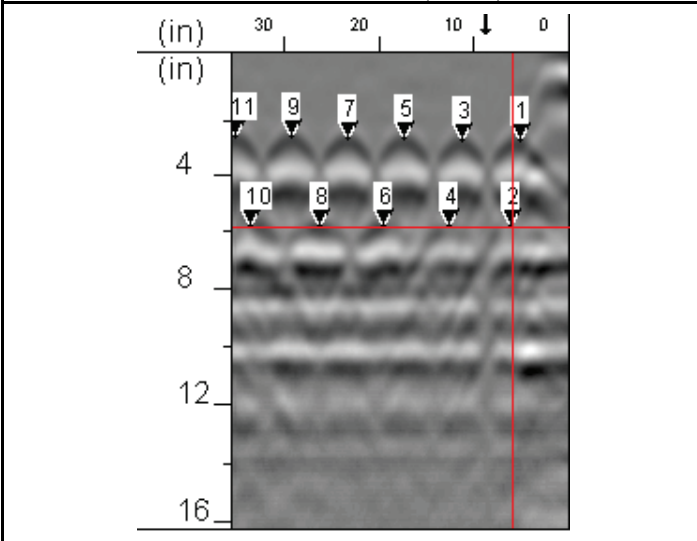

N/A

Handy Search (JRC/Proceq)

Aladdin System (IDS/Olson Instruments)

Figure C.10. GPR Scanning Images for Longitudinal Rebars for Slab #1 taken on February 03, 2012 - Summary for 45-day Old Reinforced Specimen.

Slab #2: 32-day Old Reinforced Specimen (Concrete Curing Effect)

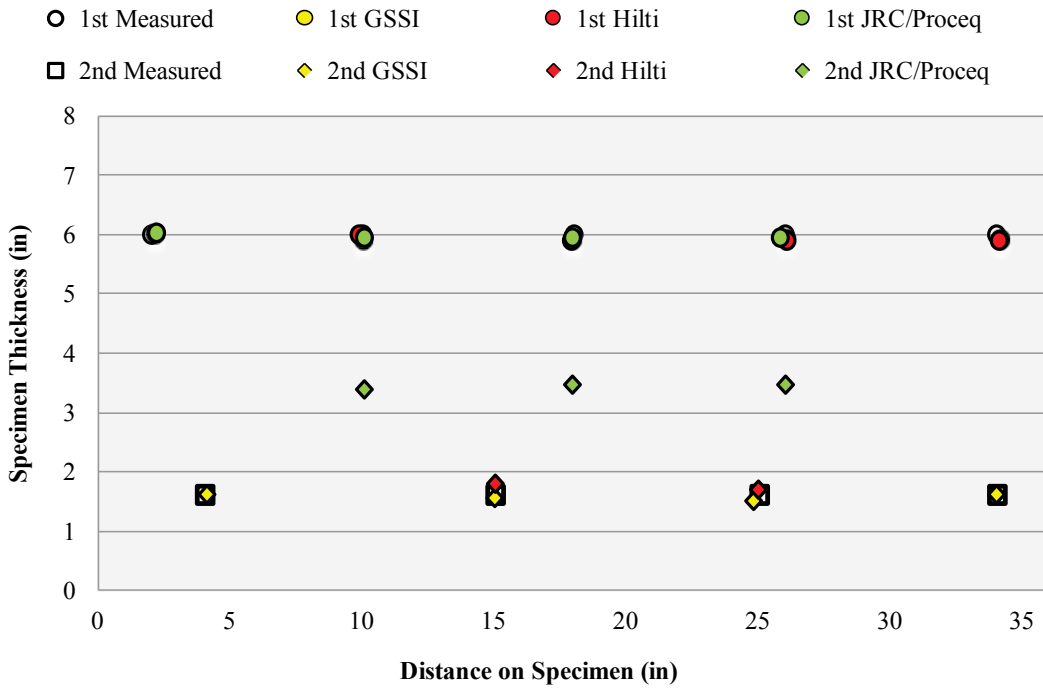

(a) Transverse Rebars

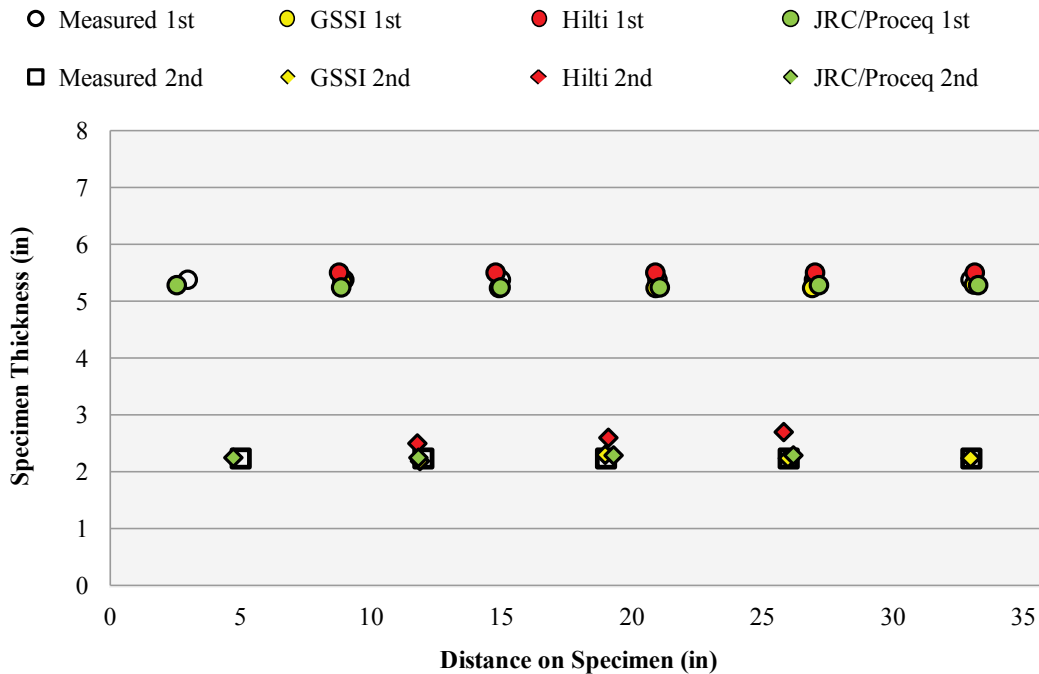

(b) Longitudinal Rebars

Figure C.11. GPR Results for Slab #2 - 8-inch Thickness Reinforced Specimen (Concrete Curing Effect) - Summary for February 03, 2012 Testing.

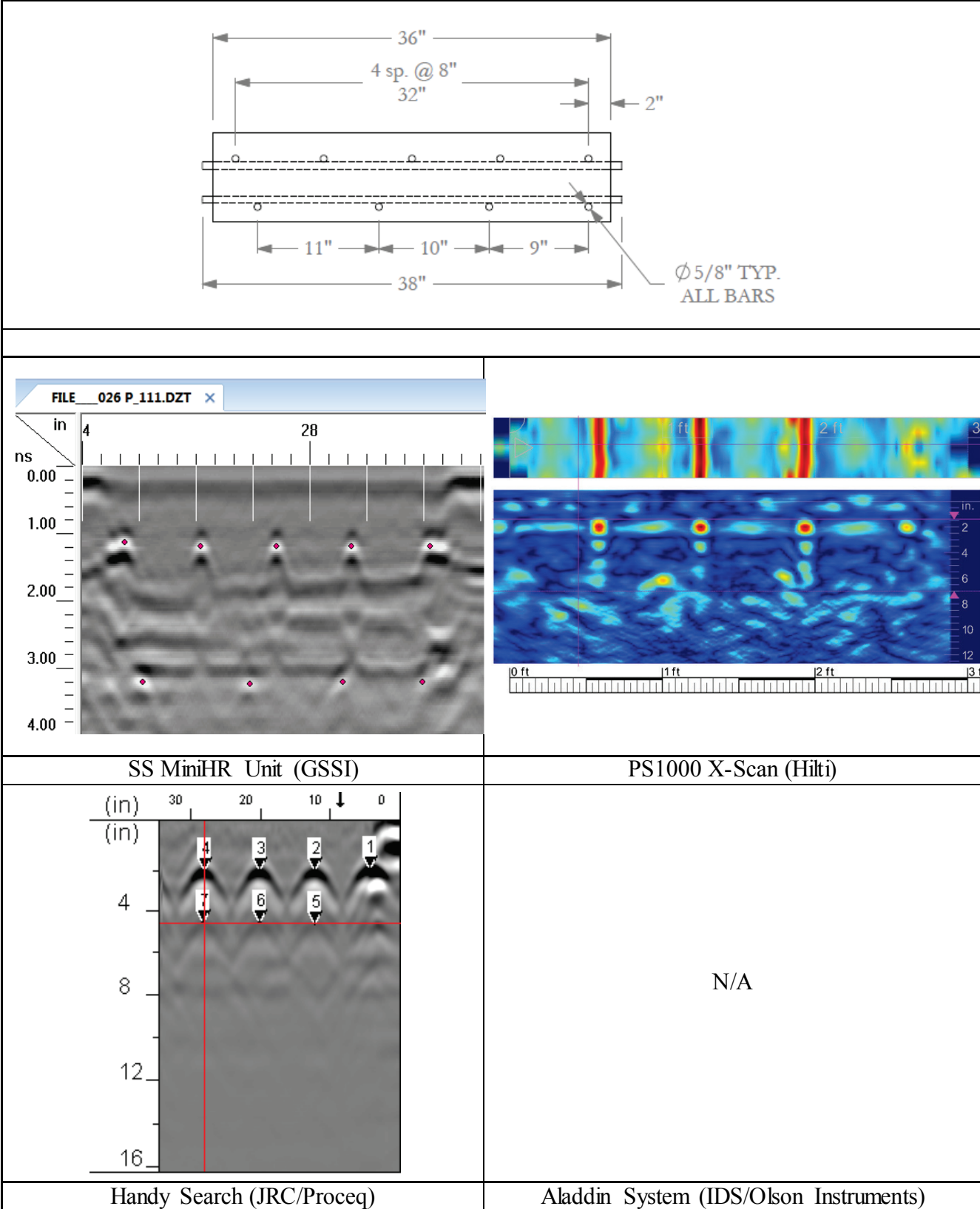

Figure C.12. GPR Scanning Images for Transverse Rebars of Slab #2 taken on February 03, 2012 - Summary for 32-day Old Reinforced Specimen.

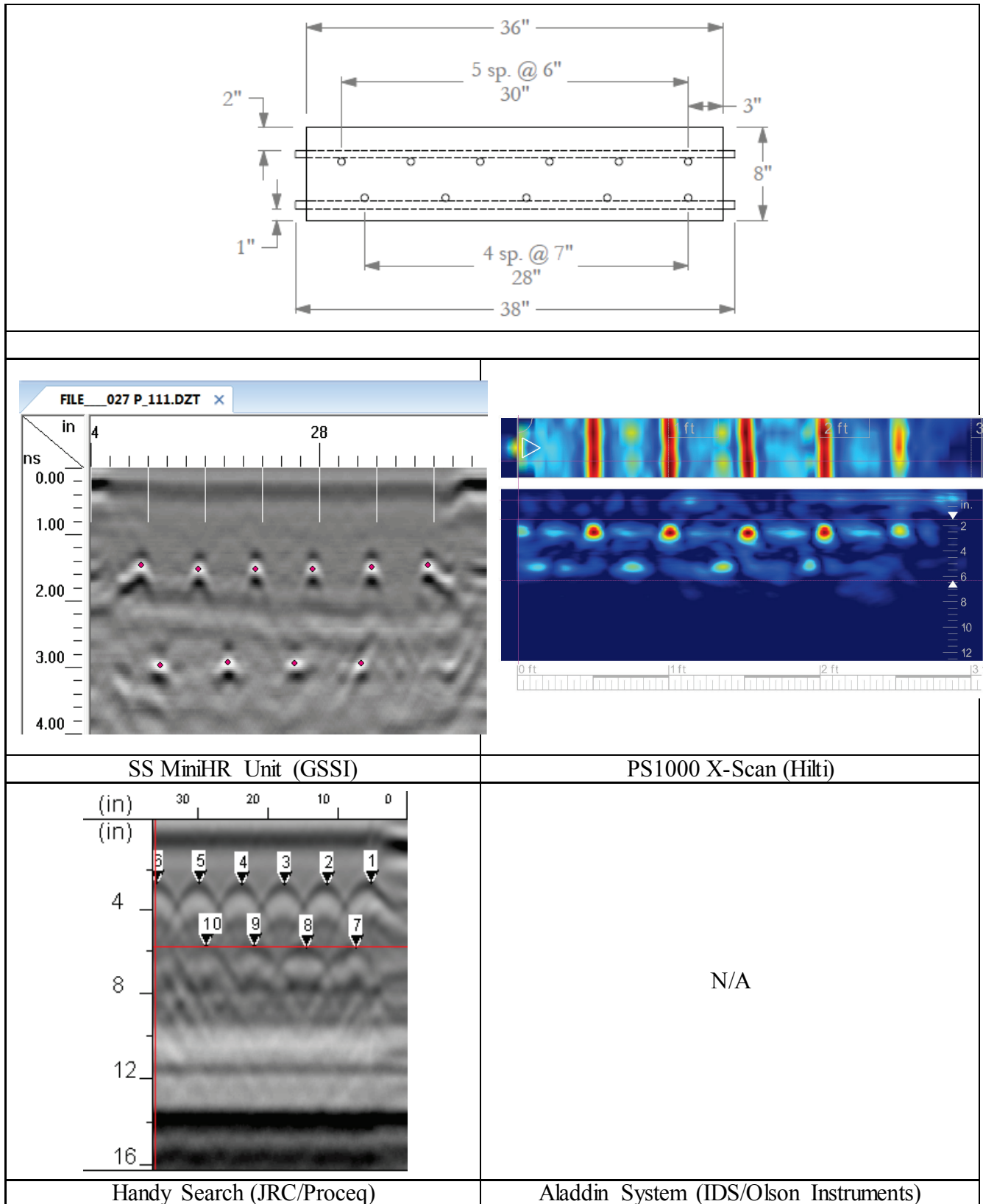

Figure C.13. GPR Scanning Images for Longitudinal Rebars of Slab #2 taken on February 03, 2012 - Summary for 32-day Old Reinforced Specimen.

**APPENDIX D: GSSI - GROUND PENETRATING RADAR -
STRUCTURESCAN™ MINI SERIES**

GSSI, 12 Industrial Way, Salem, NH 03079-4843, P: 1-603-893-1109, F: 1-603-889-3984,
www.geophysical.com, sales@geophysical.com
<http://www.geophysical.com/structurescanmini.htm>



StructureScan™ Mini Series

Complete GPR Systems for Concrete Inspection and Analysis



- | | |
|----------------------------------|--|
| 1 All-in-One handheld GPR system | 3 Easy to use operator interface with color display screen |
| 2 Ergonomic handle and controls | 4 Survey wheel encoder |
| | 5 Guiding laser for locating |

Compact Design

The StructureScan Mini makes concrete inspection easy in tight spaces

Integrated Tool

All-in-one concrete inspection tool - antenna, positioning system and control unit combo

System Flexibility

The StructureScan Mini is offered in two versions, the original system with our popular 1600 MHz antenna, or the new system with a 2600 MHz antenna for high resolution data

Durability

Ruggedized plastic casing and wheels for long-lasting performance

Value

The perfect blend of price and performance, backed by a two-year warranty



www.geophysical.com

StructureScan Mini Series

Introducing the Mini - our smallest StructureScan system. The StructureScan Mini Series is ideal for locating the position and depth of rebar, conduits, post-tension cables, and voids in concrete. The high resolution, LED backlit 5.7" display provides a detailed image of the subsurface structure. In addition to viewing, the data image can be stored directly to a SD-RAM card for later playback, or transferred to a computer for printing or integration into a report.

The StructureScan Mini Series offers a lightweight alternative to other GPR systems, weighing in at just over three pounds. The small size of the unit makes it easy to transport to the job site and once on site, convenient to scan around obstacles and into tight spaces. The Mini is very easy to use - new users will become proficient in a few short hours. The Mini aids in target detection by marking the data on screen with a small dot when characteristics of rebar or conduit are identified. The lasers on the side of the unit indicate the exact location of the center of target for accurate marking of targets embedded in the concrete.



StructureScan Mini

Deeper Signal Penetration

The StructureScan Mini is GSSI's portable integrated GPR system for concrete inspection. This handheld unit is used to locate rebar, conduits, post-tension cables, voids and determine concrete slab thickness.

With a 1600 MHz antenna, and depth penetration of up to 20 inches (50cm), the StructureScan Mini offers the perfect blend of data resolution and depth. Used worldwide, it has quickly become the standard for concrete imaging. Additionally, the StructureScan Mini is available with 2D or 3D capabilities, flexible for your job site needs.

System Specifications

Center Frequency: 1600 MHz
Depth Range: Up to 20 inches (50 cm)
Unit Weight (with battery): 3.3 pounds (1.6 kg)
Dimensions: 6 (w) x 7 (h) x 9 (l) in. (15.24 x 17.78 x 22.86 cm)
Languages: English, Spanish, French
Environmental: IP-65

1600 MHz

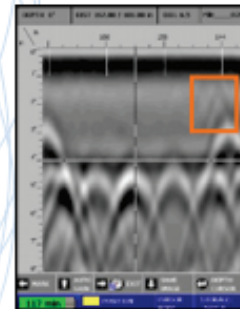

Data showing a small 5/8" plastic conduit (less visible) over rebar mat.

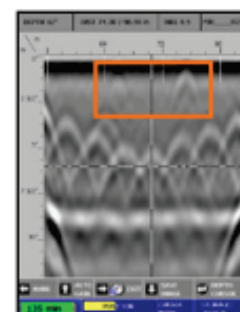

Small 1/2" conduits (less visible) very close to surface. Note strong horizontal reflection, representing bottom of slab.

StructureScan Mini HR

Outstanding Data Resolution

The StructureScan Mini HR is GSSI's all-in-one high-resolution GPR system for concrete inspection. With a 2600 MHz antenna, this handheld system locates rebar, conduits and post-tension cables in depths of up to 16 inches (40 cm).

The StructureScan Mini HR is available in two models; 2D, for real-time target location and 3D, for an x-ray like image. Ideal for complex areas, the StructureScan Mini HR can delineate small targets with superior vertical and horizontal resolution.



2600 MHz

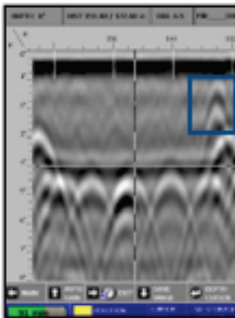

Data showing a small 5/8" plastic conduit over rebar mat.

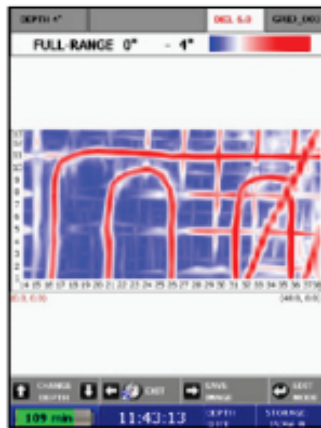

Collected with StructureScan Mini HR, data represents 3D image of radiant heating tubing in concrete slab.

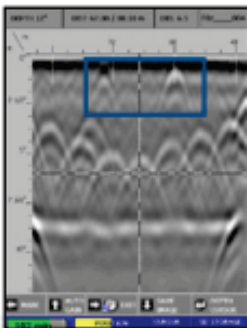

Small 1/2" conduits very close to surface. Note sharp hyperbola tails.

Typical Uses for StructureScan Mini Series

- Concrete inspection – locate metallic and non-metallic targets in walls, floors and ceilings
- Structure inspection – bridges, monuments, walls, towers, tunnels, balconies, garages, decks
- Condition assessment – map relative concrete condition for rehab planning
- Measure slab thickness
- Void location

System Specifications

Center Frequency: 2600 MHz
Depth Range: Up to 16 inches (40 cm)
Unit Weight (with battery): 3.3 pounds (1.6 kg)
Dimensions: 6 (w) x 7 (h) x 9 (l) in. (15.24 x 17.78 x 22.86 cm)
Languages: English, Spanish, French
Environmental: IP-65

Software Solutions

RADAN® for StructureScan Mini

RADAN for StructureScan Mini is specifically made for the StructureScan Mini Series. It is designed to process, view, and document 2D data collected with the StructureScan Mini. RADAN for StructureScan Mini can perform the following functions:

- Copy images to third party software for documentation purposes
- Save images
- Print to all Windows supported printers
- Background Removal filtering
- Establish Ground Truth for near accurate depth calculation
- Dielectric calculation
- Colorize the data
- Add targets and export target information in an Excel format
- Gain (contrast) control

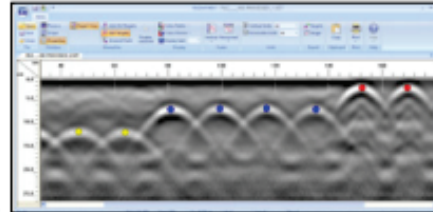

RADAN® 7

RADAN is GSSI's post-processing software for GPR data. With its modular design, RADAN allows users to select the processing functions that best suit their professional needs. RADAN is Windows based, providing a familiar and easy to use environment for all levels of experience.

The RADAN software features bold and intuitive menu screens and clear data views for easier interpretation and enhanced post-processing capabilities.

StructureScan Module—This powerful module allows for easy creation of plan-view slices to aid in interpretation of StructureScan data files.

- Semi-automatic mapping of reinforcement locations and depths on simple concrete structures

3D Module—Process, view, and document 2D or 3D data with the 3D module, which provides enhanced 3D viewing options in a single dialog box. Users can stretch, shrink or zoom in on files as desired for customized presentation results.

- Interactive 3D mapping of conduits or other subsurface features within concrete structures

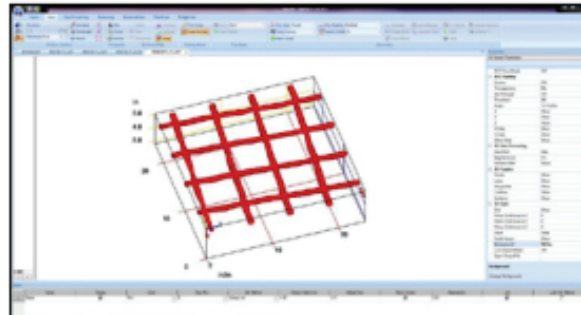

Screen shot of RADAN 7 3D Module; three-dimensional image of a rebar mat.

StructureScan Mini Viewer

The StructureScan Mini Viewer software is a free online visualization program for the GSSI StructureScan Mini. The software is ideal for basic post processing of 2D StructureScan Mini data files.

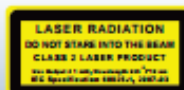

Copyright © 2012 Geophysical Survey Systems, Inc.
January, 2012

Systems Include

- StructureScan Mini or StructureScan Mini HR
- Dual Battery Charger
- Two Batteries
- Hand Strap
- Transit Case
- Quick Start Guide
- Training Video
- Data collection grids (3D system)
- 2-year warranty

www.geophysical.com • sales@geophysical.com

12 Industrial Way • Salem, NH 03079-2837
Tel: (603) 893-1109 • Fax: (603) 889-3984

Concrete Inspection Antenna Solutions

2600 MHz: High-Resolution Antenna

The 2600 MHz is an ultra-high resolution antenna used to inspect concrete structures to locate embedded rebar, post tension cables and conduits. Depth Range: to 12 in (0.4 m)

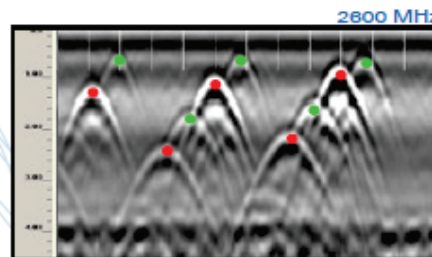

1600 MHz: General Purpose Antenna

The 1600 MHz is a high-resolution, all-purpose antenna used to inspect concrete structures to locate embedded rebar, post tension cables and conduits. It is used on bridge decks for condition assessment and to determine concrete cover. Depth Range: to 18 in (0.5 m)

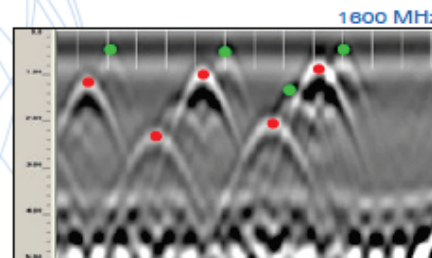

1000 MHz: Deep Penetration Antenna

The 1000 MHz antenna represents the state-of-the-art in shallow earth or deeper concrete imaging. This antenna is appropriate in areas where higher frequencies do not provide adequate penetration and lower frequencies do not provide acceptable resolution. Depth Range: to 24 in (0.6 m)

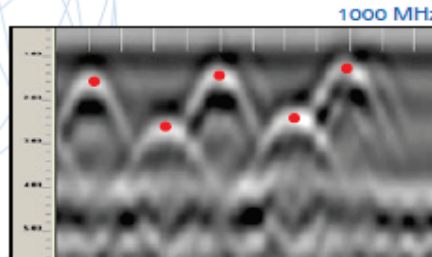

Concrete slab with rebar and PVC conduit, same slab for all data sets.
● Rebar
● PVC

2000 MHz: Palm Antenna

The new Palm Antenna offers users the ability to reach tightly spaced areas that were previously inaccessible such as corners, against walls and around obstructions.

The Palm Antenna is compatible with the SIR-3000 and SIR-20 control units. The antenna includes a dedicated survey wheel, a replaceable skid plate, and removable handle to reduce antenna height, if necessary. The Palm Antenna weighs in at approximately one pound. Depth Range: to 12 in (0.4 m)

2000 MHz Palm

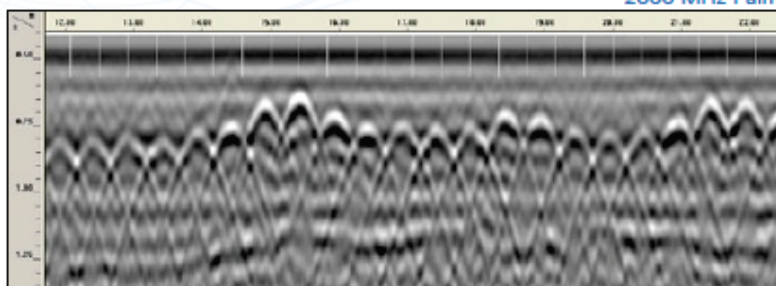

6-inch spacing wire mesh in concrete.



www.geophysical.com

Software Solutions: Structure Identification

RADAN Software

RADAN™ is GSSI's post-processing software. With its modular design, this program allows users to select the processing functions that best suit their needs.

RADAN is Windows™ based, providing a familiar and easy-to-use environment for all levels of experience.

Get More from Your Data with RADAN's Structure ID Module

RADAN's Structure ID Module provides powerful features for processing GPR data from GSSI's concrete inspection systems. Features include:

User-Friendly Interface

- Built for all levels of experience- RADAN's Structure ID Module is a Windows™ based software program that provides a familiar and easy-to-use setting for post-processing GPR data.
- Enhanced and simplified 3D viewing.

Easy Data Processing

- Take some of the human error out of the equation with semi-automatic mapping of rebar locations and depths on simple concrete structures.
- Interactive mapping of conduits or other subsurface features within concrete structures.
- Semi-automatic mapping of deterioration zones within concrete structures.

Module Versatility

- This module allows for a broad range of civil/structural applications, including structures with different types of reinforcement. Use the Structure ID Module in other applications to automatically find point targets such as utility crossings or archaeological features with lower frequency antennas.

Generic ASCII Output Files

- Permits simple integration with spreadsheets or other programs.

Help Feature

- Help feature includes key information, several "how to" guides, index and search feature.

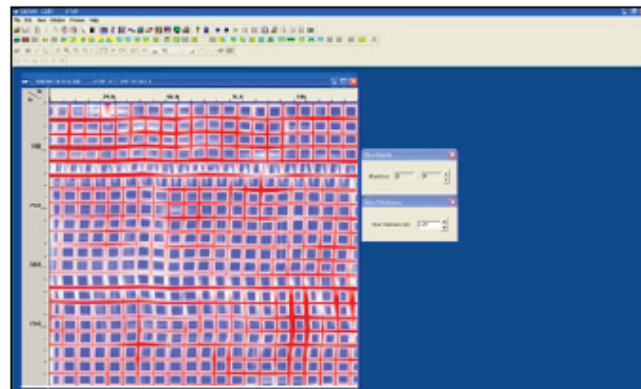

10 ft x 10 ft section of wire mesh. Note overlaps.



Copyright © 2009 Geophysical Survey Systems, Inc.
July, 2009

www.geophysical.com • sales@geophysical.com

12 Industrial Way • Salem, NH 03079-4843
Tel: (603) 893-1109 • Fax: (603) 889-3984

APPENDIX E: *HILTI* - COVER METER - FERROSCAN PS-200

Hilti Corporation, 9494 Schaan, Liechtenstein, P: 1-423-234-2111, F: 1-423-234-2965,
www.hilti.com

http://www.hilti.com/data/editorials/-12237/brochure_PS200_W3333_en.pdf

HILTI

Hilti PS 200
Ferroscan

Overview of application possibilities and examples for rebar analyses



Determining the position, depth and diameter of rebar can be problematic in everyday construction work.

In the PS 200 Ferroskan, Hilti has therefore developed a portable, quick and simple-to-operate system that solves all these problems and many more:

- Finding a secure drilling point for drilling or coring work
- Carrying out structural analyses quickly and exactly in a non-destructive manner
- Determining coverage over the entire surface of a structure

This brochure should provide you with an overview of the range of applications of the Hilti PS 200 Ferroskan. It also offers answers and solutions to questions and problems that our customers are confronted with on a worldwide basis.



Contents

Reinforcement verification (Pages 4–7)

Checking coverage (Pages 8–9)

Avoiding rebar hits (Pages 10–11)

Tips and tricks taken from practical experience (Pages 12–15)

Reinforcement verification

Task:

- Changing usage of buildings without plans
- Acceptance inspections of concrete components
- Checking reinforcement before structural repair
- Post-installed reinforcement

Scan solution:

- Imagescan
- Quickscan for controlling purposes

Analysis:

- Position of the reinforcing bars
- Depth of concrete coverage
- Rebar diameter

Objects:

- Industrial buildings, floors and ceilings, beams, supporting columns, etc.





Checking coverage

Task:

- Building acceptance inspections
- Checking coverage over a large area during renovation
- Quality control

Scan solution:

- Quickscan
- Imagescan in difficult situations

Analysis:

- Concrete coverage

Objects:

- Bridges, tunnels, underground garages, etc.



Avoiding rebar

Task:

- Hammer drilling or coring without the costly problem of hitting rebar
- No cutting through statically relevant reinforcing bars
- Increase the working life of the tool and drill/core bit

Scan solution:

- Quickscan
- Imagescan for through-drilled holes

Analysis:

- Position of the reinforcing bars

Objects:

- Repetitive fastening applications, ventilation ducts, through holes, etc.



Example 1 Changing the use of a building

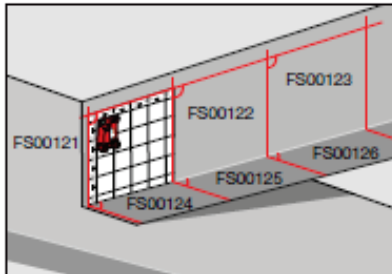

Beam

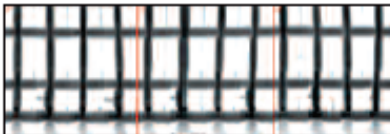
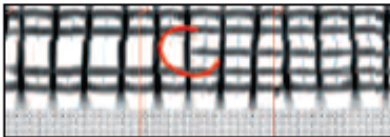
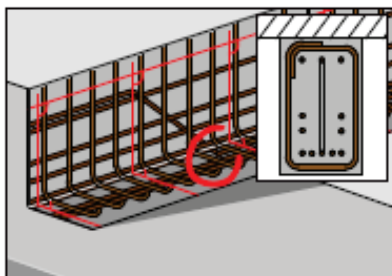
Imagescans FS00121 to FS00123
(from the side)Imagescans FS00124 to FS00126
(from below)

Layout of reinforcement

Situation

A large workshop building is to be altered to suit a new purpose. Accordingly, static verification of the reinforcement in the beams in the lower floor level must be obtained. The spacing and diameter of the stirrups as well as the number of longitudinal reinforcing bars, and their position and diameter, must be determined. Plans showing the reinforcement no longer exist.

Procedure

The overall situation should be assessed and the areas to be scanned marked on the beams.

Several Imagescans are made on both sides of each beam (at least three scans or Blockscan). It is then possible to determine the position of the stirrups, the position of the longitudinal bars and the location of any bends. Several Imagescans should also be made on the underside of each beam (at least three scans or Blockscan). These scans will show the position of the stirrups, the number of bars in the lower section and the points at which the bars bend upwards.

Interpretation of the results

The positions of the stirrups and the longitudinal reinforcing bars are clearly visible in the Imagescans from the sides of the beams.

In the Imagescan taken from the underside, an upward bend is detected in the middle of the beam. This can be clearly interpreted from the image where, at the centre, a reinforcing bar seems to disappear. The number of longitudinal bars can be determined simply by counting them. The "Calculate Depth / Ø" evaluation function can be used to estimate the diameter of the bars. The values obtained should be confirmed by drilling a number of inspection holes.

Use of the Ferrosan PC software is recommended for this task as the data obtained can be saved at the same time for future reference.



Example 2 Renovation of an old building



Situation

An old factory building is undergoing conversion near a service elevator. Static verification of the supporting beams affected must thus be obtained. It is necessary to determine what reinforcement is in place as no detailed structural plans are at hand. The spacing and diameter of the stirrups as well as the number of longitudinal reinforcing bars, their diameter and position, has to be determined.

Procedure

The points where scans are to be made should be marked on the beams. Several Imagescans are then taken from both sides of each beam. The position of the stirrups, the position of the longitudinal

reinforcement and any upward bends of the bars are then visible.

Several Imagescans should also be made on the underside of each beam.

The position of the stirrups, the number of reinforcing bars on the underside and any upward bends of the bars then become apparent.

Interpretation of results

In this case, the reinforcement is positioned in such a way that a good assessment of the situation is not possible. The physical limits of the electromagnetic scanning principle are exceeded as the reinforcing bars are very closely spaced and deeply set in the concrete. It is thus necessary to expose the reinforcement at certain points. Only then can the situation be examined in detail. Nevertheless, use of the Ferroskan system has the advantage of providing a good general overview, thus ensuring that inspection holes can be drilled at the correct locations.

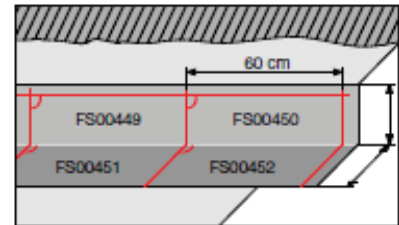

Beam



Imagescans FS00449 to FS00450
(from the side)

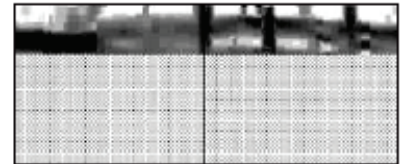

Imagescans FS00451 to FS00452
(from below)

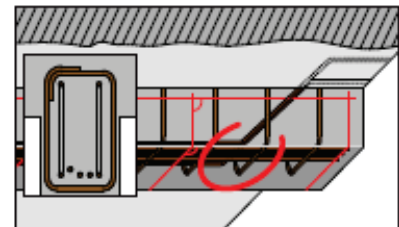

Layout of reinforcement

Example 3 Positioning post-installed reinforcement

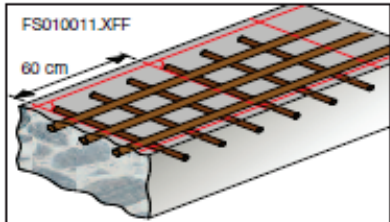

Reinforcement

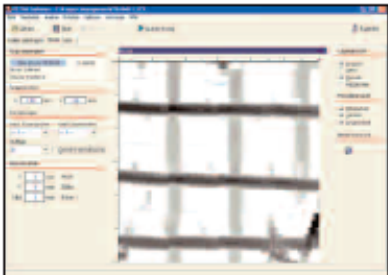

Imagescan FS010011.XFF

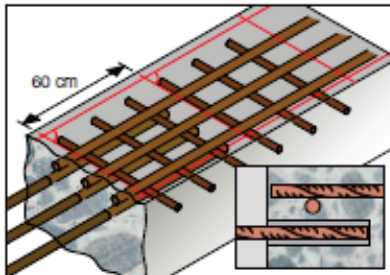

Connecting reinforcement

Situation

In accordance with the REBAR approval regulations, the position of reinforcing bars must be marked when it is not clear from the building plans what reinforcement exists and how it is positioned.

Procedure

As a rule, the Quicksan detection function can be used and the position of the reinforcing bars then marked with a marker. In uncertain situations, it is an advantage when an Imagescan is made first, thus providing an initial overview of the reinforcement. The Imagescan should be made at the area of the reinforcing bar connections.

Interpretation of results

It is important that the position of the transverse bars as well as the longitudinal bars is known for anchorage of the reinforcing bars. The transverse bars, which normally lie above the longitudinal bars, must not hinder drilling. In this situation, however, the transverse bars are found to be located below the longitudinal bars. When positioning the holes to be drilled for the connecting bars, care must be taken to ensure adequate clearance and distance from edges.



Example 4 Verifying length of overlap



Situation

The length of overlap of the horizontal reinforcement in a silo with a diameter of 20 m has to be verified. The spacing of the horizontal and vertical reinforcement is known.

Vertical: 20 mm diameter bars spaced at intervals of 25 cm.

Horizontal: 20 mm diameter bars spaced at intervals of 12.5 cm (center of bar).

Length of overlap (l_o) = approximately 1.2 m

The Ferroskan system is to be used to obtain verification of the specified values.

Procedure

A series of adjacent Imagescans or Blockscan is made in the area of the overlapping connection. Additional scans must be made to ensure that the images extend at least 50 cm beyond each end of the connection (see diagram).

The position of the reinforcing bars detected can then be marked on the structure, thus permitting inspection

holes to be drilled at the appropriate locations.

Interpretation of the results

The overlapping section can be identified by the vertical displacement of the horizontal bars, as seen in the image at bars numbers 1, 2 and 4 (counted from above). The overlap begins between the first and second vertical bars and ends at the sixth vertical bar. The overlap of the third bar begins between the sixth and seventh vertical bars. Between the second and the sixth vertical bars, the third individual horizontal bar appears thinner than the first and second horizontal bars. This is because the magnetic field created by overlapping horizontal bars numbers 1, 2 and 4 is twice as strong as that of bar no. 3. Visual assessment of the image is confirmed by evaluation of the Imagescans. Evaluation of the data from the overlapping section indicates a diameter of 36 mm. In contrast, a diameter of 20 mm is indicated at the section beyond the overlap (diameter value for the overlapping section is thus approximately twice that of the single bars).

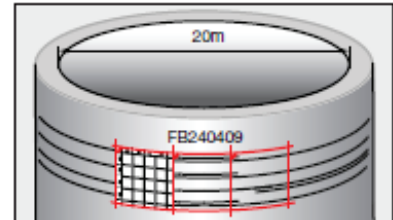

Grain silo



Blockscan FB250409

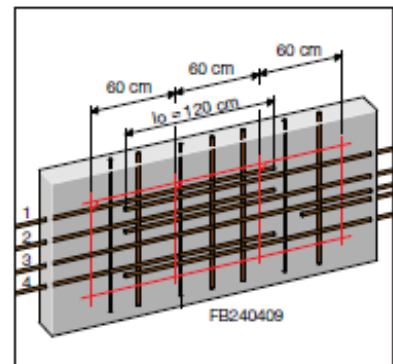

Section of the grain silo

Example 5 Tunnel acceptance inspection

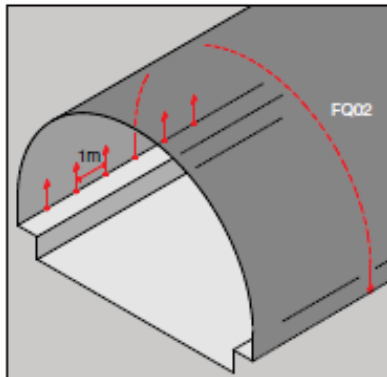

Profile of the paths to be scanned

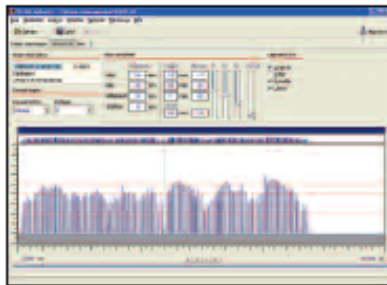

Quickscan evaluation

Situation

The depth of coverage over the reinforcement in the concrete lining of a tunnel is to be checked for quality assurance purposes. The specified nominal values for the depth of concrete coverage and reinforcing bar diameter are known.

Procedure

To ensure maximum accuracy of the depth of coverage values obtained, the known reinforcing bar diameter is entered in the Ferroskan system. All paths to be scanned should be marked on a plan. Additional Imagescans can be made at critical points to provide a better visual representation of the situation. The individual scanned paths (Quickscans) are subsequently evaluated on a PC.



Interpretation of results

Evaluation provides a mean value calculated from all individual measurements. When defining the paths to be scanned, care should be taken to ensure that no overlapping sections (joints) are included in the scans. The double bars at overlapping sections usually result in indication of less depth of coverage.

Example 6 Underground parking garage



Situation

The depth of concrete coverage over reinforcement in the beams has to be verified for the building acceptance inspection of an underground parking garage. The specified minimum depth is 30 mm.

Procedure

Quickscans are made over the entire length of the beams from the front, rear and underside.

Interpretation of the results

The Quickscans clearly show that the depth of coverage on the sides of the beams is, for the greater part, within specifications. On the underside, however, depth of concrete coverage is obviously inadequate.

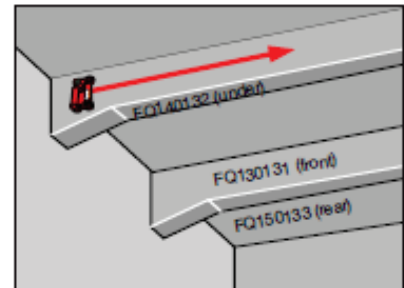

Beams in an underground parking garage

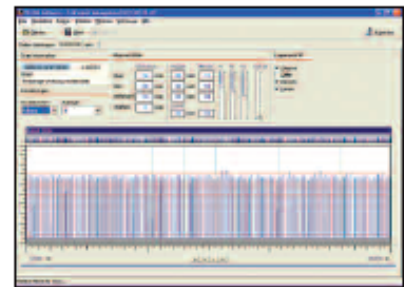

FQ130131 (front)



FQ130131 (under)

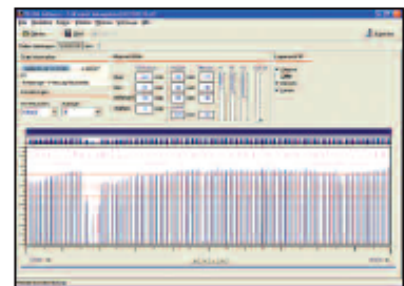

FQ130131 (rear)

Example 7 Coring through a beam for pipe installation

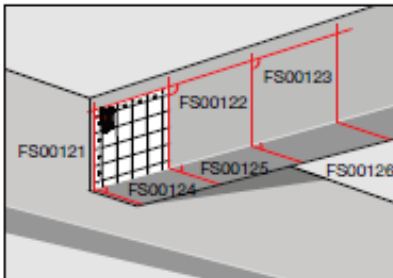

Beam

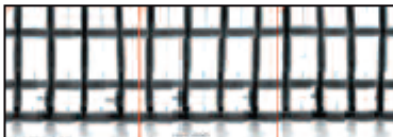
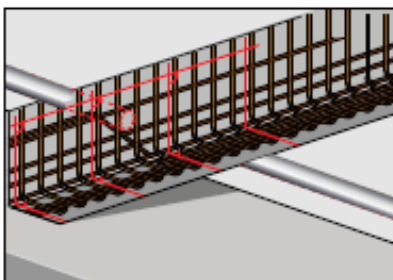
Imagescan FS00121 to FS00123
(from the side)Imagescan FS00124 to FS00126
(from below)

Layout of reinforcement in the beam

Situation

For the installation of a pipe it is necessary to core through a supporting beam although cutting through reinforcing bars is not permissible. What is the maximum core bit diameter that can be used for drilling? Where can the hole be drilled? Generally speaking, work of this kind can be carried out only after the engineer responsible has been consulted.

Procedure

The overall situation should be assessed and the areas to be scanned marked on the beams.

Several Imagescans are made on both sides of each beam (at least three scans or Blockscan). It is then possible to determine the position of the stirrups, the position of the longitudinal bars and the location of any bends.

Several Imagescans should also be made on the underside of each beam (at least three scans or Blockscan). These scans will show the position of the stirrups, the number of bars in the lower section and the points at which the bars bend upwards.

Interpretation of the results

The maximum core bit diameter can be determined from the spacing of the stirrups not to be cut through (plus a safety factor). The distance between the stirrups can be determined from the images.

In the case illustrated, no bars bending upwards can be seen in the scans made from the sides. In order to be certain that no bars do, in fact, bend upwards, it is necessary to view the beam from below. In the scans from the underside, it can be seen that the middle bar suddenly disappears into the concrete, thus indicating a bend upwards at an angle of 45° at this point in the beam. The positions on the beam where diamond coring is possible can be determined and marked by transferring the scanned images to the concrete surface.



Example 8
Avoiding rebar hits when installing a noise barrier



Situation

To avoid hitting reinforcement when setting anchors (especially in critical steel-reinforced components such as columns and beams), marking the position of the reinforcement on the concrete surface prior to drilling can be of great assistance.

Procedure

Blockscans should be made at the points where holes are to be drilled. By referencing from the Blockscans to the structure, the positions of the rebars can be marked on the concrete and then located more quickly using Quickscan detection.

Interpretation of the results

The positions of the components to be installed can be marked on print outs of the Blockscans and archived.

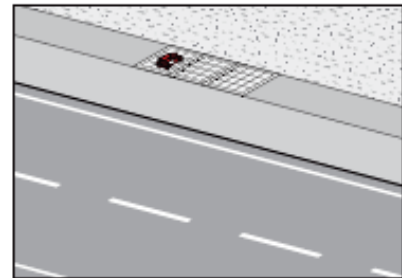

Concrete base of the motorway wall is scanned

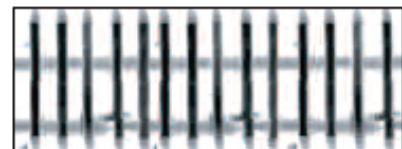

Blockscan image

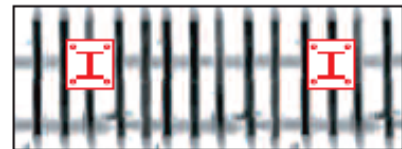

The elements to be forced to the base are positioned, avoiding rebar



Safe fastening of the sound barrier without hitting rebar

Tips and tricks taken from practical experience

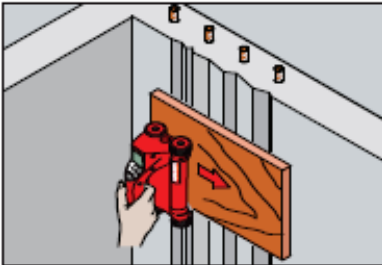

Scanning on rough surfaces

A rough surface causes interference signals when the scanner is moved across it. This interference may cause so-called artifacts to appear in the Imagescan, thus negatively affecting evaluation of the scan, similar to the image, "interpretation of special cases 1." Simultaneous placement and movement of all four rubber wheels of the scanner is not always possible. To obtain good scan results, a thin board, a thick sealing foil or thin polystyrene foam sheet can be laid on the surface where the scan is to be made. The thickness of the surface overlay used must be taken into account in evaluations.

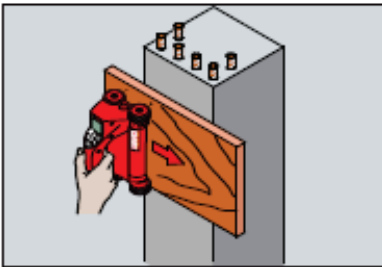

Using a surface overlay board

The reinforcement close to the edges of narrow components cannot be scanned and assessed.

The scanned area, however, can be enlarged by placing a cardboard, plastic or wooden overlay on the surface of the concrete. The scanner can then be moved easily beyond the edge of the component. When working in this way, it is important that the thickness of the overlay is taken into account when the scans are evaluated.

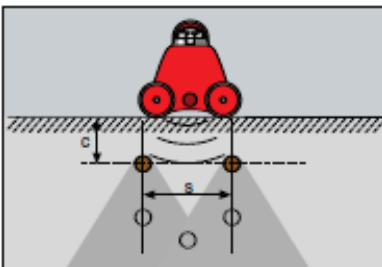

Shielding of the second layer

When parallel reinforcing bars are located one above the other, only the bar closest to the surface is visible on the screen. Various layers of reinforcing bars running parallel can only be detected and displayed if they are spaced sufficiently, i.e. not within the "shadow" of the bars nearer the surface.

The scanner can distinguish adjacent bars only when spacing (s) is at least double the depth of coverage (c). Only by drilling or chiseling out an inspection slit is it possible to determine whether a reinforcing bar is present in the second layer.

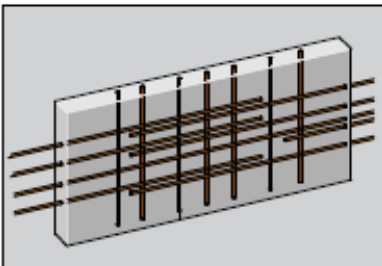

The limitations of scanning

It is essential that inspection holes are drilled when the results obtained by scanning are uncertain (e.g. at complicated joints and overlaps).

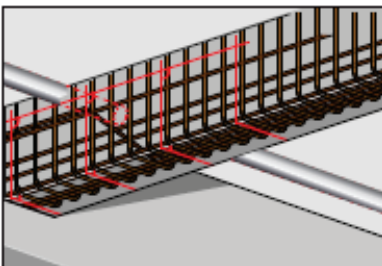

Scans where through holes are to be made

Holes drilled through supports and beams are, as a rule, statically critical. Scans should thus always be made from at least two or, preferably, three sides.

Scan from both sides – max. depth approx. 12 cm.

Tips and tricks taken from practical experience

Scraps of reinforcement

Scraps of reinforcement are usually encountered only at the underside of surfaces where forming has been in place. Scatter and variance in the Imagescan is an indication of the presence of scraps of reinforcement in the concrete. Similarly, an indistinct image is produced when the concrete contains aggregates with ferromagnetic properties.

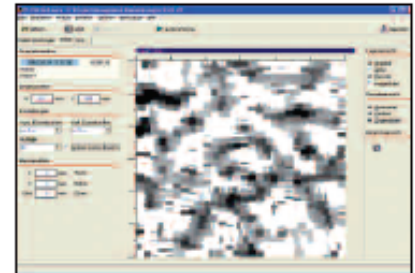

Calibration for improved scanning results

When the measurements obtained are of relevance to safety, results must always be confirmed by drilling inspection holes or taking comparative measurements. If necessary, more accurate values may be obtained by calibrating the Imagescan or by entering a known diameter value in the case of a Quickscan.

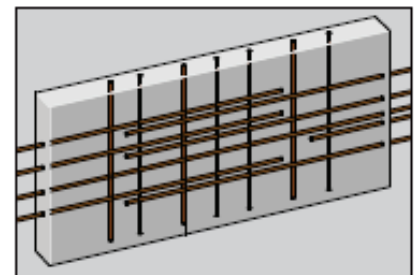

Plausibility test

There are always several possible methods of assessment for every scanning / measurement task. In the image shown it is obvious that the outermost bars are, in fact, the corner rails of the plaster covering.

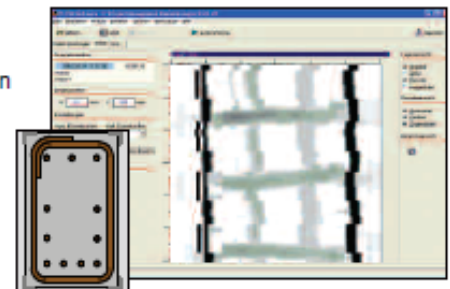

Identifying double bars

Double bars can be identified reliably only by drilling an inspection hole. An exception to this can be made when, for example, the diameter of the individual bars is known and the Ferroskan system/PC evaluation indicates twice this diameter. In new buildings and structures and, particularly, in the case of pre-cast components, the drawings and plans should indicate where double bars are present.

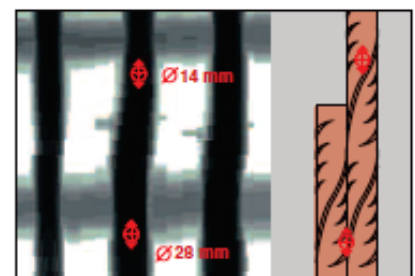

Tips and tricks taken from practical experience

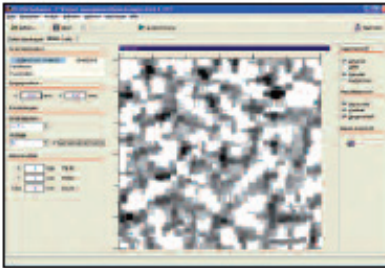

Interpretation of special cases 1

Depending on their density, the presence of aggregates with ferromagnetic properties in the concrete makes it impossible to determine the pattern of reinforcement beyond a certain depth.

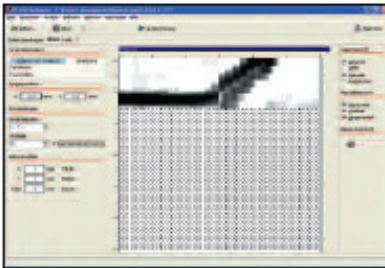

Interpretation of special cases 2

A clearly visible bend at an upward angle in a beam when viewed from the side. Calculations of depth and diameter are not possible or reliable.

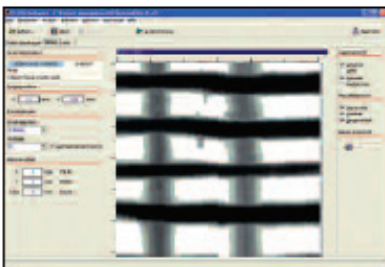

Interpretation of special cases 3

More accurate results may be obtained when horizontal bars are calibrated. At the point between the vertical bars, the third individual bar appears to be thinner than the other horizontal bars.



Quickscan for localizing reinforcement bars



Imagescan – scanning with a reference grid



The possibility for voice recording/commentary

PS 200 Ferrosan

Portable, non-destructive steel reinforcement detection system

Uses

- Verification of reinforcement: locate rebar when plans are missing, for acceptance inspections, before structural repair or change of loads on a structure.
- Verification of concrete cover over reinforcement: obtain concrete cover information over large areas for acceptance inspections, before renovation or for quality control.
- Avoid hitting rebars: avoid cutting through critical reinforcement or costly rebar hits.

Benefits

- Immediate high resolution image for a clear picture of the reinforcement.
- Determine bar depth and estimate diameter.
- Determine average concrete cover over large areas easily.
- Reduce wear on drill/core bits and tool motors when drilling through reinforcement. Reduce drilling times – important in repetitive drilling applications.
- Avoid potentially disastrous and costly hits on critical reinforcement.
- Cableless connection between monitor and scanner. No cable to snag or hinder your movement.
- Includes powerful PC software for office analysis and easy creation of reports.

Performance data

Scanner memory capacity	Up to 9 Imagescans plus up to 30 meters of recorded Quickscans
Monitor memory capacity / type	At least 150 Imagescans or 75 Quickscans plus up to 15 min. of voice recording (32 MB)
Battery life	8 hours on average
Protection class	IP 54 in accordance with IEC 529
Operating temperature range	-10°C to +50°C
Dimensions / weight of scanner	260 × 132 × 132 mm / 1.4 kg
Dimensions / weight of monitor	264 × 152 × 57 mm / 1.4 kg
Minimum system requirements for PC software	Microsoft Windows 2000, XP, at least 50 MB free hard disk space, CD-ROM drive, USB V1.1 interface

Right of technical changes reserved.

Detailed information on the operating instructions and PC software download can be found under www.hilti.com/ferrosan

APPENDIX F: *HILTI* - GROUND PENETRATING RADAR - PS1000 X-SCAN

Hilti Corporation, 9494 Schaan, Liechtenstein, P: 1-423-234-2111, F: 1-423-234-2965,
www.hilti.com

http://www.hilti.com/holcom/page/module/product/prca_productdetail.jsf?lang=en&nodeId=-450121&selProdOid=1107559

Applications

- Quality assessment of rebar and PT cable layout
- Inspection of floors, decks, slabs, balconies, etc.
- Helps identify safe spots to drill, core or saw
- Analyze and evaluate scanned data for detailed report generation

Outperform

- Locates various objects up to 12 inches in concrete
- Compact all-in-one hand-held scanner
- 2D and 3D visualization of objects concealed in concrete structures

Outlast

- Durable, rubber coated housing for jobsite protection
- Resistant to water and dust in typical jobsite conditions



Inside insight.

PS 1000 X-Scan Radar Detection System

The Hilti PS 1000 X-Scan is designed to produce large-area images of what's inside concrete structures. The system consists of a hand-guided scanner with color display, a portable monitor unit for on-site use plus professional PC software for image evaluation and data management. Scans can be analyzed immediately on the state-of-the-art X-Scan display. With the aid of the PSA 100 monitor, objects can be shown as 3D images for even easier on-the-spot interpretation. This makes it simple to find and mark reliable drilling locations and helps to limit damage caused by hitting rebars, pipes or post tension cables.

With the ability to provide clear 2D or 3D images of all kinds of objects concealed in concrete structures, the new Hilti PS 1000 X-Scan Radar Detection System takes non-destructive inspection of concrete to another level.



*Some limitations apply. Contact Hilti for details.



Technical Data	PS 1000
Max. depth (in) for determining object localization	12 in
Localization accuracy	+/- 0.5 in
Accuracy of depth indication	< 4 in: +/- 0.5 in > 4 in: +/- 15% in
Protection class	IP 54, battery IP 56
Operating temperature	5 to 122 °F
Battery life with Li-Ion battery (scanner only)	4 h
Scanner dimensions	12.5 x 5.6 x 7.5 in
Scanner weight (including battery)	5.4 lb

Hilti. Outperform. Outlast.



Order Information

Description	Package Contents	Item No.
PS 1000 X-Scan	Includes scanner, (2) PSA 81 battery packs, mains adapter, memory card, adapter, PROFIS PS 1000, (5) PSA 13 reference grids, (2) PSA 15 reference grids, hand strap, adhesive tape, marker set, brush, torque wrench, cleaning cloth, data module, Producer Certificate and operating instructions in an impact-resistant plastic tool box	03484548
PS 1000 X-Scan System	Includes scanner, PSA 100 monitor, (2) PSA 81 battery packs, (1) PSA 82 battery pack, (2) mains adapters, data cable, connecting cable, headset, (5) PSA 13 reference grids, (2) PSA 15 reference grids, monitor pouch, hand strap, adhesive tape, marker set, brush, torque wrench, cleaning cloth, data module, Producer Certificate and operating instructions in an impact-resistant Hilti trolley	03484549



Accessories

PSA 100 Monitor	02006082	PSA 50 Connecting Cable	02006185
PSA 81 Battery Pack	02006182	PSA 51 Connecting Cable	02006186
PSA 82 Battery Pack	02006183	PSA 13 Reference Grid (24" x 24")	02006084
PUA 81 AC Adapter	02006089	PSA 15 Reference Grid (48" x 48")	02006086
PUA 82 Car Battery Plug	02006180	PUA 90 Adhesive Tape	00319362
PSA 95 Memory Card	02006184	PUA 70 Marker Pen Set	00340806
PSA 96 USB Memory Stick	02006187		

Hilti. Outperform. Outlast.

Hilti, Inc. (U.S.) 1-800-879-8000 www.us.hilti.com • en español 1-800-879-5000
Hilti (Canada) Corporation 1-800-363-4458 • www.hilti.ca



APPENDIX G: *PROCEQ* - COVER METER - PROFOSCOPE+

Proceq USA, Inc., 4217 Grove Avenue, Gurnee, IL 60031, P: 1-847-623-9570,
Toll Free: 1-800-839-7016, F: 1-847-623-9580, www.proceq.com, info@proceq.com
<http://proceq.com/index.php?id=258&referrer=AZOMDOTCOM>

profoscope⁺



Fully integrated Rebar Detector with Data Storage

Automatic collection of data and real time visualization of rebars to increase efficiency on the construction site

The Need for Data Storage

Manually recording the measurements of a test series is a time consuming business that can be an unnecessary source of errors. The various data storage modes of the Profoscope⁺ make note taking obsolete. The cordless Profoscope⁺ is ideally suited for one-handed operation, keeping the other hand free for marking rebars. The combination of the unique midpoint detection algorithm and the integration of the new memory function allows the fastest possible measuring performance at an affordable price.

ProfoLink

Data Analysis made simple

Data exchange can be done easily by connecting the Profoscope⁺ directly to the USB-port of the PC or by reading out the integrated Micro SD-memory card. The included Windows based software ProfoLink allows the user to comfortably download, edit and present the data measured by the Profoscope⁺. The most common international units and rebar dimensions are supported, and converting the data is straightforward. All data can be exported either in graphic format or as a text file to third party applications.

Benefits to the Customer

All in one solution; Economical instrument combining rebar detector and covermeter with an intuitive operator interface.

Ease of use; The innovative and widely accepted real time visualization of the Profoscope merged with a new and simple to use memory function for data acquisition.

Memory functions; Two different modes of operation are supported: Manual data storage allows the user to save concrete cover and rebar diameter on individually chosen measuring spots. Automatic data storage is especially designed for surface scans. Every time a rebar is detected, the cover value is stored automatically.

Data export and analysis; The ProfoLink software offered by Proceq is a professional tool to make clear assessments of the results.

Durability; Sealed housing for use in rough environment with replaceable protection cover for long lasting performance, over a wide temperature range.

Made in Switzerland

... more than 50 years of know-how you can measure!

profoscope⁺

Memory Function and Profolink

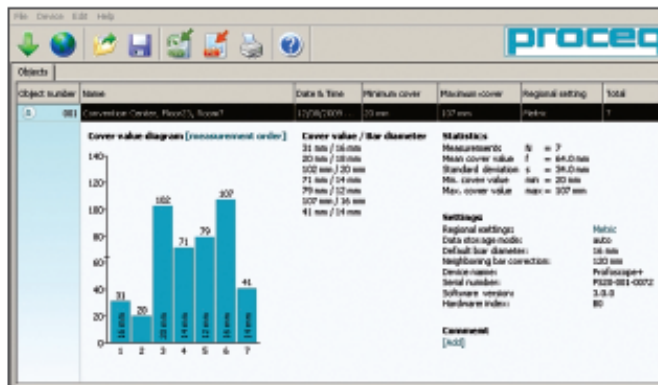
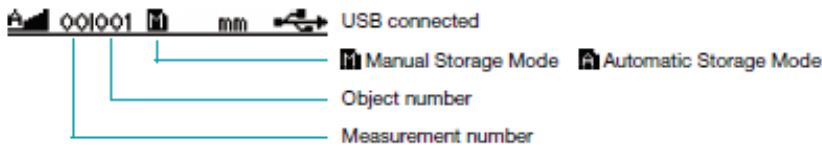

The graphic display of the Profoscope⁺ shows all necessary information while acquiring data on site.

The collected measurement values can then be analyzed comfortably with the Profolink PC tool.

Technical Information

Measuring performance and technical information are identical to the Profoscope

Data Storage

49'500 measurements total (500 objects with 99 measurements)

Compatibility Profolink: Windows 2000, XP, Vista, 7

Accessories

Standard Accessories delivered with the Profoscope⁺

391 80 100	Canvas bag
350 74 025	Battery type AA
391 80 110	Carrying strap
391 80 803	USB cable type A-mini B
391 80 111	Memory card microSD, 2GB
391 80 112	CD Incl. Profolink

Optional Accessories

391 10 121S	Self-adhesive protection covers (Set of 3)
390 00 270	Calibration test block
325 34 018S	Chalk (Set of 10)

Ordering Information

Unit	
Part Number	391 20 000
Profoscope ⁺ unit consisting of:	
Profoscope ⁺ Incl. start-up test kit and accessories (batteries, memory card, USB-cable, canvas bag, carrying strap, chalk, documentation, Profolink software)	

Service & Warranty Information

Proceq is committed to providing complete support for the Profoscope⁺ by means of our global service and support facilities. Furthermore, each Profoscope⁺ is backed by the standard Proceq 2-year warranty and extended warranty options. Please check the Profoscope Sales Flyer for further details or www.proceq.com.

Subject to change without notice.

All information contained in this documentation is presented in good faith and believed to be correct. Proceq SA makes no warranties and excludes all liability as to the completeness and/or accuracy of this information. For the use and application of any product manufactured and/or sold by Proceq SA explicit reference is made to the particular applicable operating instructions.



APPENDIX H: *PROCEQ* - COVER METER - PROFOMETER®5+

Proceq USA, Inc., 4217 Grove Avenue, Gurnee, IL 60031, P: 1-847-623-9570,
Toll Free: 1-800-839-7016, F: 1-847-623-9580, www.proceq.com, info@proceq.com
<http://www.proceq.com/index.php?id=37&pqr=2&setpqr=1&L=0>



REBAR DETECTION SYSTEM

- Location and orientation of reinforcing bars
- Measuring concrete cover depth
- Determination of bar diameter
- Compact, user-friendly indicating device with backlight
- ProVista PC software for fast data transfer and editing
- Can be operated in metric and Imperial units

PROFOMETER 5+ utilizes the non-destructive pulse-induction method



Standards: SN 505 262 • DIN 1045 • DGZfP B2 • BS 1881: Part 204

proceq

www.proceq.com

profometer[®] 5⁺

Model S • Basic Instrument

Various location aids are available:

- Current value:** Distance from surface of reinforcement
- Flow bar:** Movement of flow bar indicates approach to metal object
- Beep tone:** Sounds immediately after crossing the bar axis. Selectable in two frequencies.
- Variotone:** The closer the probe to the bar, the higher the tone
- Signal value:** Measure of distance from probe to metal object

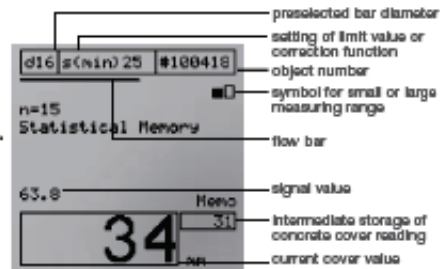

«Measuring with statistics» function

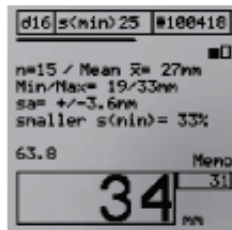

The statistical evaluation of the stored memo values appears when the END button is pressed.

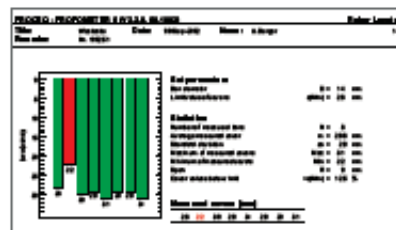

Data transfer to PC and evaluation with ProVista Software

Determine the bar diameter of closely spaced parallel bars

The instrument compensates the influence of the neighboring bars.

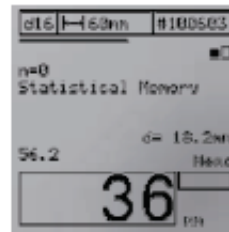
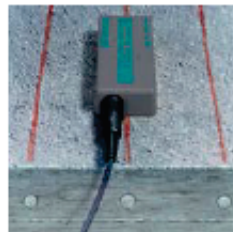

Measure the cover depth in congested bar arrangements

Measure the bar spacing and select the measuring mode. The instrument compensates for the influence of the adjacent bars.

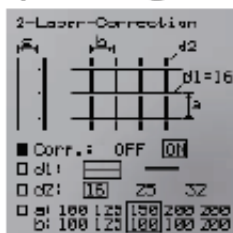

Detect bars with insufficient concrete cover

Suggested applications:

- Check after removing formwork
- Quality assurance
- Evaluation basis for repair

The universal probe can be moved rapidly with the preselected limit value. If the cover is too low, an acoustic warning signal is given.

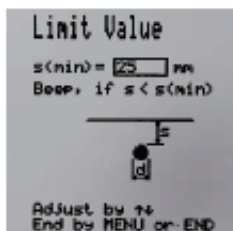

www.proceq.com

profometer[®] 5⁺

Modell SCANLOG • Identical to Model S – with these additional Features:

- "CyberScan" function to visualize reinforcing bars on the display
- "Measuring with grid" function for grey-scale display of concrete cover
- ScanCar probe cart with integrated path measuring device for scanning



Make reinforcement visible with "Cyber Scan"!

Three scales are available: 0.5 x 0.5m, 1.0 x 1.0m, 2.0 x 2.0 m

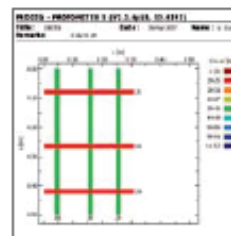
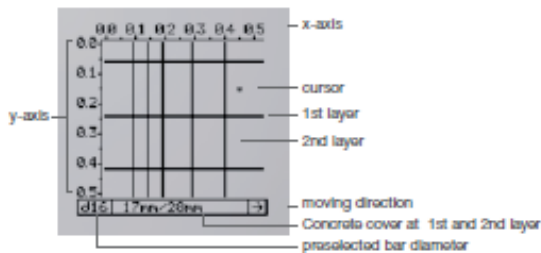

Data transfer to the PC and processing with ProVista Software

«Measuring with grid» function

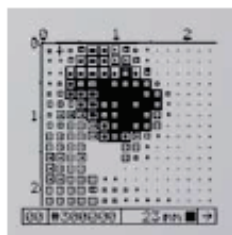

Display

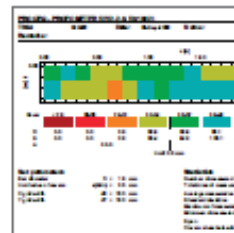

Data transfer to the PC and processing with ProVista Software

Measuring ranges and accuracy of the cover reading for individual bars...

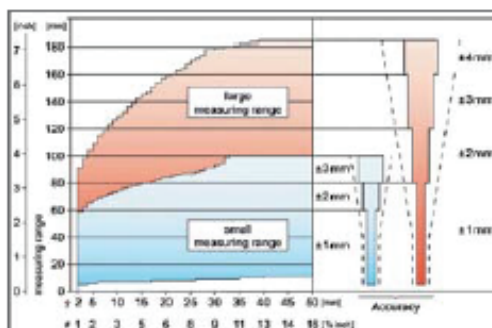

- ∅ bar diameter in mm
- # bar diameter in «Bar size»
- accuracy required by BS 1881: Part 204: ± 2 mm or ± 5%

...and unsurpassed resolution

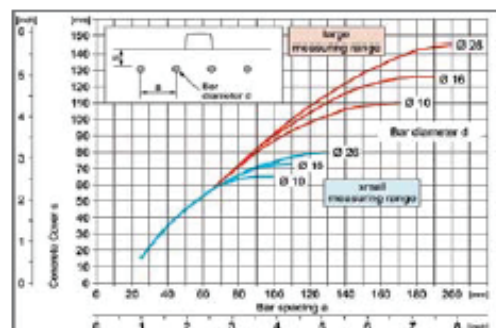

The diagram shows the minimum bar spacing (a) at which the bars can still be individually detected as a function of the concrete cover (s).

- Example : Bar diameter d = 16 mm
- Concrete cover s = 55 mm
- Minimum bar spacing a = 70 mm

proceq

www.proceq.com

profometer[®] 5⁺

Technical Information

Indicating device Model S

MEMORY: non-volatile memory for 40'000 measured values and 60 objects respectively

DISPLAY: LCD with backlight option

INTERFACE: RS232 or with Adapter for USB Port on PC

SOFTWARE: ProVista for downloading data and evaluation on PC

BATTERIES: 6 x 1.5V for 45h operation; 30h with backlight on

TEMPERATURE RANGE: -10° to +60°C

Universal probe

Probe for locating rebars and measuring cover depth in two depth ranges as well as determining rebar diameters.

Indicating device Model SCANLOG

The unit is identical to Model S, with additional features for the Cyberscan and the measuring with grid function.

Memory capacity: 120'000 values in function measurement with grid and a total of 60 objects.

Model S can be upgraded to Model SCANLOG. Contact Proceq for details.

Ordering Information

UNIT MODEL S

390 00 050 Rebar Detection System PROFOMETER 5⁺ Model S
Includes Indicating device, universal probe, probe cable 1.5m, transfer cable 1.5 m, adapter RS232/USB, ProVista Software on memory stick, carrying strap, headset, protective sleeve for Indicating device, operating instructions, carrying case, total weight 4.2 kg

UNIT MODEL SCANLOG

390 00 054 Rebar Detection System PROFOMETER 5⁺ Model SCANLOG
Identical to Model S, with the additional features plus probe cart ScanCar with path measuring cable 1.55 m, total weight 4.5 kg

ACCESSORIES FOR BOTH MODELS

390 00 270 Test block
390 00 363 Telescopic rod for universal probe or ScanCar
390 00 280 Marking pen for universal probe

REPLACEMENT PARTS

390 00 068 Universal probe
390 00 084 Protective film for universal probe
390 00 470 Protection sleeve for indicating device
390 00 163 Probe cable 1.5 m
390 00 168 Path measuring device cable 1.55 m
390 00 456 Transfer cable 9/9 poles
390 00 542 Adapter RS 232 / USB
390 00 078 Carrying case
820 39 001 Operating instructions

Subject to change without notice.

All information contained in this documentation is presented in good faith and believed to be correct. Proceq SA makes no warranties and excludes all liability as to the completeness and/or accuracy of the information. For the use and application of any product manufactured and/or sold by Proceq SA explicit reference is made to the particular applicable operating instructions.

Sales and Service Contacts:

Europe/Africa
Proceq SA
Ringstrasse 2
CH-9603 Schwerzenbach
Switzerland
Phone: +41 (0)43 955 38 00
Fax: +41 (0)43 955 38 12
Info-europe@proceq.com

Americas
Proceq USA, Inc.
117 Corporation Drive
Alliquippa, PA 15001
USA
Phone: +1-724-512-0330
Fax: +1-724-512-0331
Info-usa@proceq.com

Asia/Pacific
Proceq Asia Pte Ltd
12 New Industrial Road #02-02A
Singapore 596202
Republic of Singapore
Phone: +65-6382-3986
Fax: +65-6382-3307
Info-asia@proceq.com



proceq



Main components



Test block



Telescopic rod for universal probe or ScanCar



Marking pen for universal probe

**APPENDIX I: *JRC/PROCEQ* - PORTABLE GROUND PENETRATING
RADAR - HANDY SEARCH**

Proceq USA, Inc., 4217 Grove Avenue, Gurnee, IL 60031, P: 1-847-623-9570,

Toll Free: 1-800-839-7016, F: 1-847-623-9580, www.proceq.com, info@proceq.com

[http://www.proceq.com/fileadmin/images/products/Concrete/gpr/PQUSA_Handy_Search_100411.p
df](http://www.proceq.com/fileadmin/images/products/Concrete/gpr/PQUSA_Handy_Search_100411.pdf)

handy search



High Resolution, Portable Ground Penetrating Radar (GPR): Handy Search

Handy Search provides higher definition and deep-sensing for rebar detection using pioneering radar technology.

The Benefits of Radar Technology for Concrete Testing Applications

As the density of rebars increases to improve the durability of concrete structures, so does the need for detection instruments with higher resolution. The design and development of the latest-generation Handy Search instrument addresses these industry requirements for deeper and higher definition searching and locating.

The Handy Search portable Ground Penetrating Radar (GPR) system incorporates radar technology enabling users to conduct surveys deeper into a concrete structure for high resolution sensing of rebars and other metallic and non-metallic objects. Understanding and pinpointing the location of these objects is critical to avoid the potential problem of accidentally cutting through a rebar, electrical conduit, gas pipes or plumbing. The Handy Search can also detect voids within the concrete structure.

How It Works

The device radiates electromagnetic waves through a concrete surface and catches reflected waves from embedded objects that have different electrical characteristics than concrete. Object location and depth are then recorded and displayed as simple image data. The latest generation Handy Search offers significant improvements in search resolution in the horizontal direction and better accuracy for shallow rebars over its popular predecessors.

proceq

... more than 50 years of know-how you can measure!

handy search

Features and Benefits

Compact and Lightweight

The instrument display is integrated with the antenna section, making the device a compact 2.4 lb (1.1 kg) unit which can be operated with one hand.

Detects both metallic and non-metallic objects

The radar system detects traditional metallic objects like rebars while providing location of non-metal items such as vinyl chloride pipes and voids.

Expanded depth display and calibration value

A wide-range display function shows twice the measured depth. It is possible to set dielectric constant calibration values in 0.1 steps from 2.0 to 20.0.

Data maintenance and replay

Up to 49.2 ft (15 m) of test data can be saved and replayed in a single measurement.

Wireless printing

Ability to connect without cables enables easy printing to the specialized black and white optional printer.

Expanded Image Processing Capabilities

Original, fixed, subtraction, manual, peak, average wave and user surface wave processing.

Stored user settings

Settings can be stored at device shut-down to save time when re-starting for the next project.

How to Operate Handy Search

Handy Search reveals images of the cross section of a concrete structure in a direction that intersects the search target perpendicularly. The cross section of an

object such as a reinforcing steel bar will be displayed as an angular image.

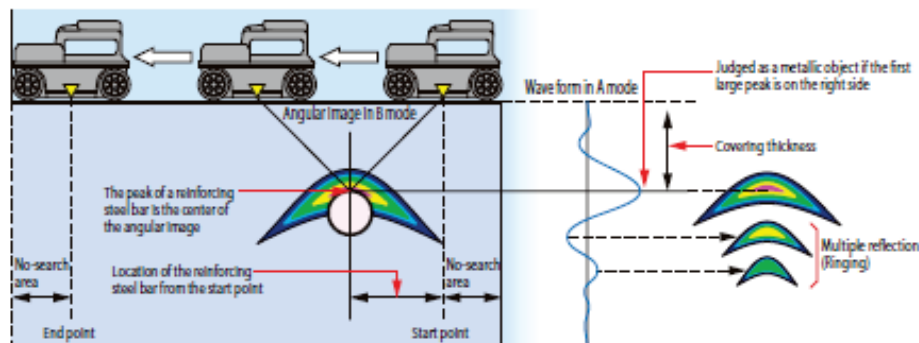

Measured Data Display Sample

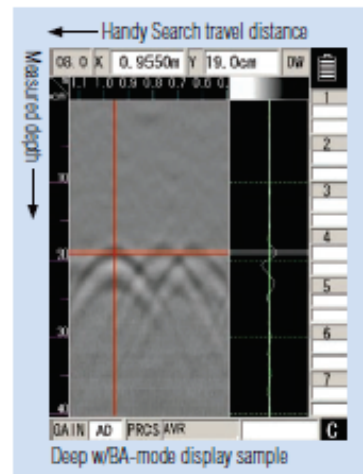
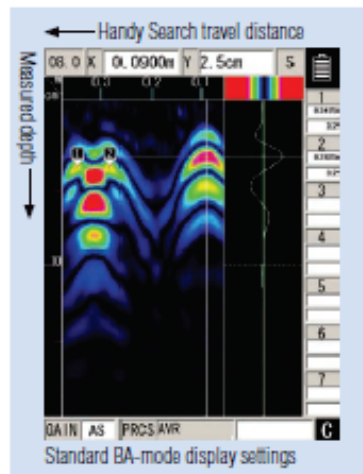
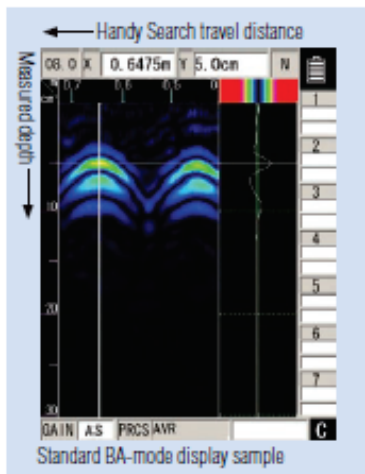

proceq

... more than 50 years of know-how you can measure!

handy search

Optional Software

RC Report Maker software increases efficiency in generating reports on a personal computer. Measurement results, image processing and marking, and subsequent

data editing are saved intact with the results displayed in JPG format.

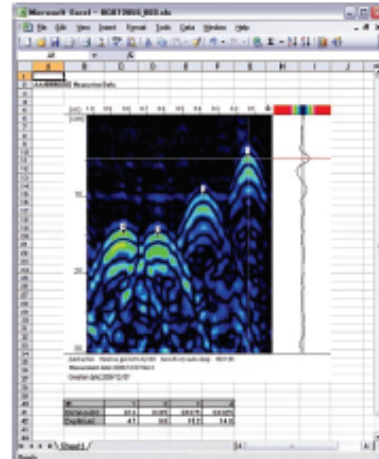
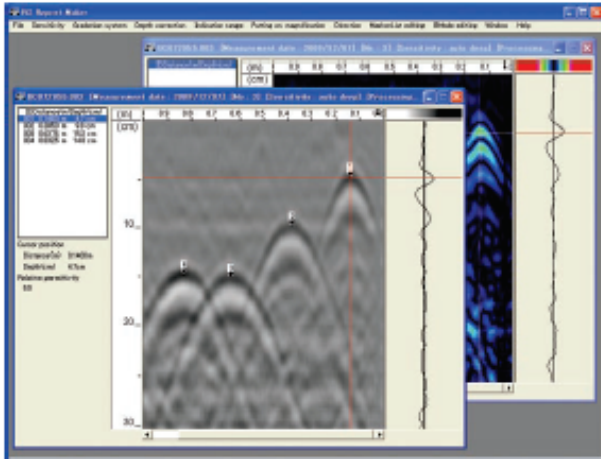

Radar 3D_Light is recommended 3D rendering software for the Handy Search system where complicated piping searches are necessary. With Radar 3D_Light, it's easy to

determine depths with a multi-colored depth display, and the ability to determine complicated piping conditions.

Moderate Depth Mode	Multi-colored depth display	Shallow mode	Multi-colored depth display
	<p>Gray display indicates the depth is outside the specified range.</p>		<p>Covering thickness can be obtained by simply adjusting the focus of an image. Three level depth range display for shallow, moderate, and deep (only depth within range is shown in color).</p>



... more than 50 years of know-how you can measure!

Technical Information

System	Electromagnetic radar
Search target	Reinforcing steel bars, vinyl chloride pipes, ducts, cavities etc.
Measuring range	0.19 to 11.81" (5 to 300 mm); (From top of reinforcement when the dielectric constant of the concrete is 6.2 and the reinforcing steel bar diameter is 0.23" (6 mm) or greater)
Resolution (cover depth)	Shallow mode: About 0.03" (1 mm) Deep mode: 0.07" (2 mm)
Resolution (horizontal distance)	0.09" (2.5 mm)
Search length	49.2 ft (15 m) maximum
Display modes	B mode (vertical sectional view), BA mode vertical sectional view with reflected waveform display)
Image processing	With search: Automatic real-time surface wave processing, manual real-time subtraction processing, and real-time user surface wave processing Without search: Fixed surface wave processing, user surface wave processing, manual surface wave processing, average wave processing, peak processing, original image replay processing
Display	TFT color LCD (640 x 480 bits)
Depth calibration	2.0 to 20 in steps of 0.1
Maximum scanning rate	About 15.74" (40 cm) per second with over-speed alarm buzzer
Display function	Cursor mark (up to 42 points), battery charge indicator, screen inversion
Output function	Dedicated-printer output function (IrDA)
Memory capacity (search data)	Compact flash. Approximately 200 passes (49.2 ft (15 M) search data saved in binary format) when using 1-GB memory
Temperature range	32 to 122°F (0 to 50°C)
Instrument dimensions	5.86"(w) x 5.78"(h) x 8.50"(d) (149 x 147 x 216 mm)
Instrument weight	2.6 lb (1.2 kg) with battery pack included

Ordering Information

Part No.	Description
390US001	Handy Search Ground Penetrating Radar (GPR). Includes Handy Search GPR instrument, (2) battery packs, battery charger, AC cable, hand strap, compact flash memory, carrying case and operating instructions
Parts and Accessories	
390US002	Printer Set. Includes printer, paper holder, battery pack and (10) rolls of recording paper. Battery charger set (390US003) not included, order separately
390US003	Battery charger set for printer. Includes charger and AC cable
390US004	RC Report Maker Software
390US005	Radar 3D_Light Software
390US006	Printer recording paper, pack of 10 rolls
390US007	AC Adapter Set for Handy Search
390US008	Battery charger set for Handy Search
390US009	Battery pack for Handy Search

Service and Warranty Information

Proceq is committed to providing complete support for the Handy Search instrument in the USA by means of our local service and support facilities. Furthermore, each instrument is backed by a 2-year warranty.

Subject to change without notice. All information contained in this documentation is presented in good faith and believed to be correct. Proceq USA makes no warranties and excludes all liability as to the completeness and/or accuracy of the information. For the use and application of any product manufactured and/or sold by Proceq USA explicit reference is made to the particular applicable operating instructions.

Proceq USA, Inc.	
4217 Grove Avenue Gurnee, IL 60031 Phone: 1-847-623-9570 Toll free: 1-800-839-7016 Fax: 1-847-623-9580 info@proceq.com www.proceq.com	117 Corporation Drive Aliquippa, PA 15001 Phone: 1-724-512-0330 Toll free: 1-800-839-7016 Fax: 1-724-512-0331



Simple Operation

1. Turn unit on.
2. To scan, depress the "Start" button. (You need to keep depressing the start button while scanning. You can take your finger off for up to 8 seconds and continue scanning. But if you don't press again the start button within 8 seconds, the scan will stop.)
3. If you would like to change the way display looks (color, monochrome, "background"/gradation) change the amplitude and disp. color from the setting screen. (See page 16 and 18 of the User Guide.) Based upon today's using in the sunlight/outdoors, you can try the different settings to improve visibility of the display.
4. If you want to re-check the scanings later, you can also save the scan by pressing "Output" button. To see the saved scanings, press the "CF" button. From there you can choose which file to "Load" (open). (See page 68.) You need to make sure which data file/folder you are saving it under though. See page 20.
5. For real time scanning, you can mark behind the back wheel on the concrete when you see the "fixed cursor pass over the center of an image.

This "fixed cursor" represents the location behind the back wheel.

When the fixed cursor passes the middle of the image, the position behind the back wheel should be "on top" of the rebar.

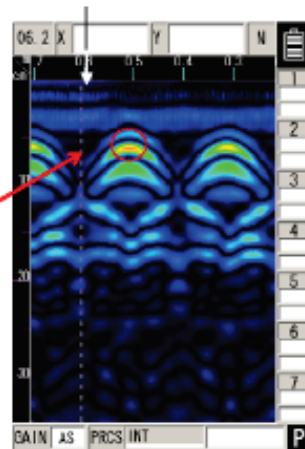

6. Adjust the Gain at any time (during or after scan) by depressing the GAIN button (Page 42.) to see images more clearly depending on depth. *When we want to see bottom rebar set to the deep Gain settings such as +1D or +2D.

7. To check/confirm rebar:

a.) metal or non-metal: Set the display mode setting to “BA” mode. (Page 17)

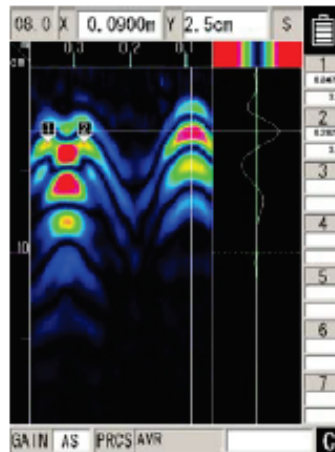

b.) image processing (page 48): To delete multiple reflected waves to enable easy deciphering of objects shown on the display. Try especially “Peak processing” (page 55) and “Deduction processing” (page 51).

8. To get the coordinates of an object:

- Stop the scan by depressing the down arrow key.
- Move both the vertical and horizontal cursors (lines) over the middle of the intended image (hyperbola).
- Coordinates (distance scanned and depth) will be shown at the top of the display screen. (See pages 42-47 for info on coordinates, marking, and saving markings.)

9. You can change display, measurement units (inches – metric), depth, display range, etc. by pressing “SET” button and changing the settings. See page 16 for more detailed info..

Parameter	Setting	Parameter	Setting
disp_color	color1	Setting at the time of the start	
disp.direction	normal	disp_color.setting	the last end
disp.mode	B	disp.direction.setting	default
amplitude	abs 	disp.mode.setting	default
X-axis	distance	amplitude.setting	the last end
depth	08.0 [+0] [----]	X-axis.setting	default
date/time	12/27/2010 11:04	depth.setting	the last end
data No.	001	output.setting	the last end
Folder	DATA	disp.range.setting	the last end
dist.adj.	+ 0 [0.0000m]	gain.setting	AS
output	printer (I)		
disp.range	N		
XY.unit	X: m / Y:cm	Cursor Maker Coordinate	
Character Mode	English	Marker	List1/DELETE MARKER ALL <ENTER>
Search PRCS	Int		
Scroll.speed	Step up		
default	NO		

Figure 2-6 Parameter setting screen

**APPENDIX J: *OLSON ENGINEERING, INC.* - GROUND PENETRATING
RADAR - ALADDIN SYSTEM**

Olson Instruments, Inc., 12401 West 49th Avenue, Wheat Ridge, CO 80033, P: 1-303-423-1212,
F: 1-303-423-6071, www.olsonengineering.com, www.olsonengineering.com
[http://www.olsoninstruments.com/pdf_downloads/Aladdin_Olson_WEB\(8.5x11\).pdf](http://www.olsoninstruments.com/pdf_downloads/Aladdin_Olson_WEB(8.5x11).pdf)



ALADDIN

An Advanced Radar Based Sensor for Nondestructive Structural Analysis



DUAL POLARIZED ANTENNA

PAD SURVEY GUIDE

WIRELESS WI-FI LINK

Distributed in
the USA by



Olson Instruments, Inc.



The "Aladdin" — Ground Penetrating Radar System

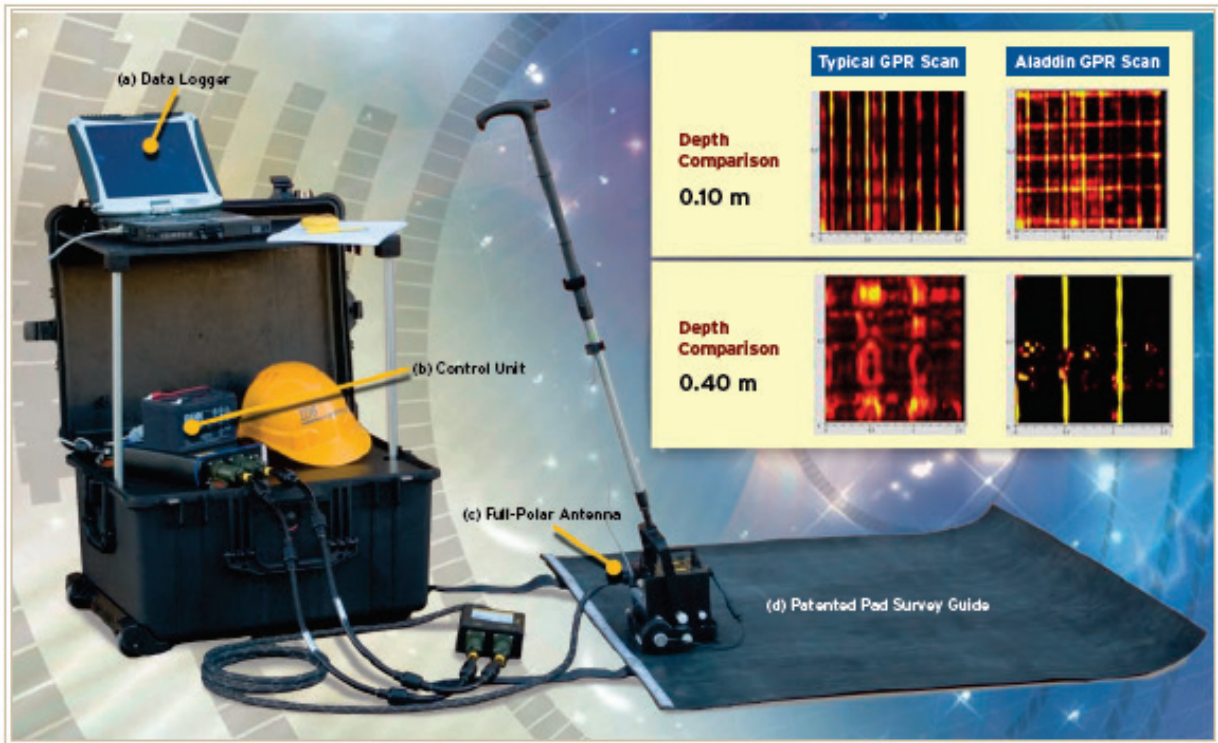

Hardware

- High Bandwidth:**
 The wide bandwidth antenna centered at 2 GHz, providing for high resolution imaging
- Dual Polarized:**
 The only antenna available that utilizes dual polarization — you need only to scan in one direction. Identify shallow and deep surveying results in half the time compared to other GPR systems!
- Wireless WiFi Link:**
 The new DAD FastWave radar control unit(b) features both a wired ethernet LAN and wireless WiFi connections to the Data Logger(a), which is a ruggedized notebook PC supplied by Olson or of the user's choice. The wireless connection is invaluable when testing conditions are less than ideal.
- Patented Pad Survey Guide Kit:**
 Acquire exceptional high resolution 3D images using the pad kit(d)

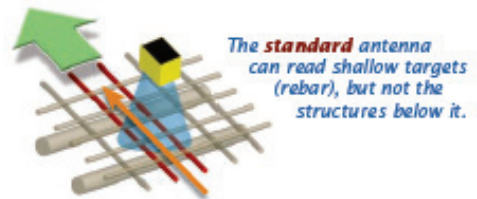



Applications

- 3D imaging of shallow and deep rebar in concrete
- 3D imaging of rebar, pre-stress and post-tensioning cables
- Locate voids in concrete
- Concrete thickness and integrity testing
- Inspection and analysis of older structures, monuments and historic buildings
- Locate pipes, hidden objects, caches, etc. in floors and walls

Benefits

- Cut testing time in half — identify shallow and deep targets in just one scan!
- Deeper surveying for shallow and deep structures
- Highest resolution 3D imaging on the market using the IDS patented pad survey guide
- Easy to use — easy to learn! Training is available



Wireless link between control unit and data logger permits easy operations in less than ideal situations

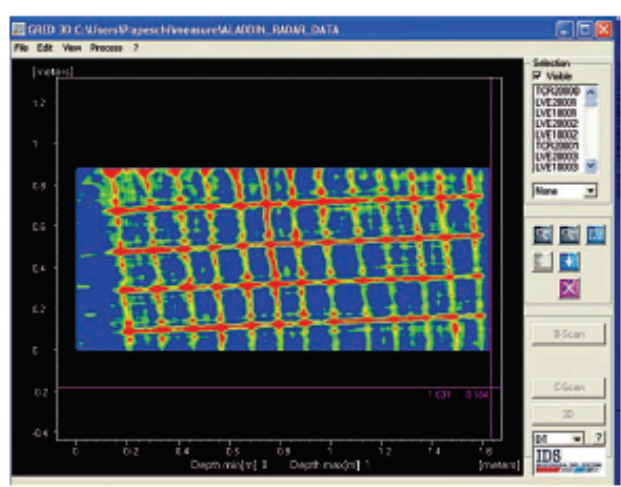

SOFTWARE

GRED 3D: Advanced processing software designed to be the optimal interface for 2D and 3D imaging.

Key Features:

- Advanced filtering
- Flexible data handling and visualization
- Spatial data representation and processing
- 3D cube representation
- Enhanced interpretation tools
- Standard printing and image export

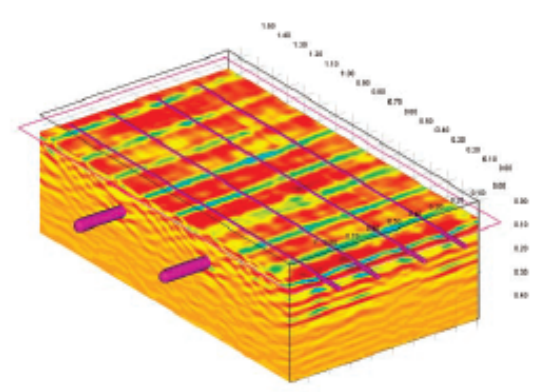

Distributed in the USA by  Olson Instruments, Inc.



Technical Specifications for the Aladdin System

Antenna	2.0 GHz, Full-Polar
Data Logger	Panasonic Toughbook CF19 PC or similar
Radar Control Unit	DAD Fast Wave 1 Channel
Operative Channels	3
Survey Method (Basic Kit)	Grooved Rubber Pad Survey Guide (PSG)
Remote Control	Handle with Remote Operation Buttons
Pulse Repetition Frequency	Up to 400 KHz
Automated Acquisition Process	Yes
Antenna Dimensions	4.8" x 4.8" x 7.25"
Antenna Weight	4.4 lbs
Battery Life	8 hrs (Aladdin), 7 hrs (Toughbook Notebook PC)
Environmental	IP 65
Elaboration Software	GED 3-D

Elaboration Software Features

» Advanced 3-D filtering and processing	» Flexible handling and visualization
» Enhanced Interpretation tools	» Standard printing and image exporting
» Easy import and processing of multiple channel data through direct link from K2 acquisition SW	» Multi-channel, multi-frequency data viewing



*Industry Leader in Nondestructive
Testing & Evaluation Systems
for Structural Integrity*



Olson Instruments, Inc.

Olson Instruments, Inc.
12401 W. 49th Avenue
Wheat Ridge, CO 80033
ph: 303.423.1212
fax: 303.423.6071
email: info@OlsonInstruments.com
www.OlsonInstruments.com
www.OlsonEngineering.com