



Transportation Pooled Fund Program



Test Report No. 405160-23-2
Test Report Date: February 2012

***MASH TEST 3-11 OF THE W-BEAM GUARDRAIL ON
LOW-FILL BOX CULVERT***

by

William F. Williams, P.E.
Associate Research Engineer

and

Wanda L. Menges
Research Specialist

Contract No.: T4541-AX
Test No.: 405160-23-2
Test Date: November 11, 2011

Sponsored by
Roadside Safety Research Program Pooled Fund
Study No. TPF-5(114)

TEXAS TRANSPORTATION INSTITUTE PROVING GROUND

Mailing Address:
Roadside Safety & Physical Security
Texas A&M University System
3135 TAMU
College Station, TX 77843-3135

Located at:
Texas A&M Riverside Campus
Building 7091
3100 State Highway 47
Bryan, TX 77807



DISCLAIMER

The contents of this report reflect the views of the authors who are solely responsible for the facts and accuracy of the data, and the opinions, findings and conclusions presented herein. The contents do not necessarily reflect the official views or policies of the Roadside Safety Research Program Pooled Fund Study, The Texas A&M University System, or Texas Transportation Institute. This report does not constitute a standard, specification, or regulation. In addition, the above listed agencies assume no liability for its contents or use thereof. The names of specific products or manufacturers listed herein do not imply endorsement of those products or manufacturers. The results reported herein apply only to the article being tested. The full-scale crash test was performed according to TTI Proving Ground quality procedures and according to the *MASH* guidelines and standards.



Wanda L. Menges, Research Specialist
Deputy Quality Manager

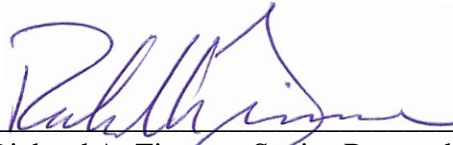

Richard A. Zimmer, Senior Research Specialist
Test Facility Manager
Quality Manager
Technical Manager

1. Report No.	2. Government Accession No.	3. Recipient's Catalog No.	
4. Title and Subtitle MASH TEST 3-11 OF THE W-BEAM GUARDRAIL ON LOW-FILL BOX CULVERT		5. Report Date January 2012	6. Performing Organization Code
7. Author(s) William F. Williams and Wanda L. Menges		8. Performing Organization Report No. Test Report No. 405160-23-2	
9. Performing Organization Name and Address Texas Transportation Institute Proving Ground The Texas A&M University System College Station, Texas 77843-3135		10. Work Unit No. (TRAIS)	11. Contract or Grant No.
12. Sponsoring Agency Name and Address Washington State Department of Transportation Transportation Building, MS 47372 Olympia, Washington 98504-7372		13. Type of Report and Period Covered Test Report: January – December 2011	
15. Supplementary Notes Research Study Title: Box Culvert Guardrail (2010) Name of Contacting Representative: Michael Elle		14. Sponsoring Agency Code	
16. Abstract <p>The primary objective of this study was to test and evaluate a guardrail design with standard post spacing for use across low-fill box culverts in accordance with <i>MASH</i> TL-3. A second objective of this study, was to develop a W6×9 post with welded base plate detail for use with an epoxy anchoring system that would simplify installation.</p> <p>The crash test performed on the W-Beam Guardrail on Low-Fill Box Culvert was in accordance with test 3-11 of <i>MASH</i>, which involves the 2270P vehicle (a 5000 lb (1/2 ton) Quad Cab Pickup). Included in this report are the details of the installation used in the crash testing, details of the full-scale crash testing, and evaluation of the crash test.</p> <p>The W-Beam Guardrail on Low-Fill Box Culvert performed acceptably according to the specifications for <i>MASH</i> test 3-11.</p>			
17. Key Words Guardrail, W-Beam, Culvert, Low-Fill, Longitudinal Barriers, Crash Test, Roadside Safety		18. Distribution Statement Copyrighted.	
19. Security Classif.(of this report) Unclassified	20. Security Classif.(of this page) Unclassified	21. No. of Pages 58	22. Price

SI* (MODERN METRIC) CONVERSION FACTORS

APPROXIMATE CONVERSIONS TO SI UNITS

Symbol	When You Know	Multiply By	To Find	Symbol
LENGTH				
in	inches	25.4	millimeters	mm
ft	feet	0.305	meters	m
yd	yards	0.914	meters	m
mi	miles	1.61	kilometers	km
AREA				
in ²	square inches	645.2	square millimeters	mm ²
ft ²	square feet	0.093	square meters	m ²
yd ²	square yard	0.836	square meters	m ²
ac	acres	0.405	hectares	ha
mi ²	square miles	2.59	square kilometers	km ²
VOLUME				
fl oz	fluid ounces	29.57	milliliters	mL
gal	gallons	3.785	liters	L
ft ³	cubic feet	0.028	cubic meters	m ³
yd ³	cubic yards	0.765	cubic meters	m ³
NOTE: volumes greater than 1000 L shall be shown in m ³				
MASS				
oz	ounces	28.35	grams	g
lb	pounds	0.454	kilograms	kg
T	short tons (2000 lb)	0.907	megagrams (or "metric ton")	Mg (or "t")
TEMPERATURE (exact degrees)				
°F	Fahrenheit	5 (F-32)/9 or (F-32)/1.8	Celsius	°C
ILLUMINATION				
fc	foot-candles	10.76	lux	lx
fl	foot-Lamberts	3.426	candela/m ²	cd/m ²
FORCE and PRESSURE or STRESS				
lbf	poundforce	4.45	newtons	N
lbf/in ²	poundforce per square inch	6.89	kilopascals	kPa

APPROXIMATE CONVERSIONS FROM SI UNITS

Symbol	When You Know	Multiply By	To Find	Symbol
LENGTH				
mm	millimeters	0.039	inches	in
m	meters	3.28	feet	ft
m	meters	1.09	yards	yd
km	kilometers	0.621	miles	mi
AREA				
mm ²	square millimeters	0.0016	square inches	in ²
m ²	square meters	10.764	square feet	ft ²
m ²	square meters	1.195	square yards	yd ²
ha	hectares	2.47	acres	ac
km ²	square kilometers	0.386	square miles	mi ²
VOLUME				
mL	milliliters	0.034	fluid ounces	fl oz
L	liters	0.264	gallons	gal
m ³	cubic meters	35.314	cubic feet	ft ³
m ³	cubic meters	1.307	cubic yards	yd ³
MASS				
g	grams	0.035	ounces	oz
kg	kilograms	2.202	pounds	lb
Mg (or "t")	megagrams (or "metric ton")	1.103	short tons (2000 lb)	T
TEMPERATURE (exact degrees)				
°C	Celsius	1.8C+32	Fahrenheit	°F
ILLUMINATION				
lx	lux	0.0929	foot-candles	fc
cd/m ²	candela/m ²	0.2919	foot-Lamberts	fl
FORCE and PRESSURE or STRESS				
N	newtons	0.225	poundforce	lbf
kPa	kilopascals	0.145	poundforce per square inch	lbf/in ²

*SI is the symbol for the International System of Units. Appropriate rounding should be made to comply with Section 4 of ASTM E380.
(Revised March 2003)

ACKNOWLEDGMENTS

This research project was performed under a pooled fund program between the State of Alaska Department of Transportation and Public Facilities, California Department of Transportation (Caltrans), Louisiana Department of Transportation and Development, Minnesota Department of Transportation, Pennsylvania Department of Transportation, Tennessee Department of Transportation, Washington State Department of Transportation, West Virginia Department of Transportation, and the Federal Highway Administration. The authors acknowledge and appreciate their guidance and assistance.

Roadside Safety Research Pooled Fund Committee CONTACTS

Revised February 2012

ALASKA

Jeff C. Jeffers, P.E.
Statewide Traffic & Safety Engineer
Alaska Department of Transportation and
Public Facilities
3132 Channel Drive
P.O. Box 112500
Juneau, AK 99811-2500
(907) 465-8962
jeff.jeffers@alaska.gov

CALIFORNIA

John Jewell, P.E.
Caltrans
Office of Materials and Infrastructure
Division of Research and Innovation
5900 Folsom Blvd
Sacramento, CA 95819
(916) 227-5824
(916) 227-5856
john_jewell@dot.ca.gov

LOUISIANA

Paul Fossier, P.E.
Assistant Bridge Design Administrator
Bridge and Structural Design Section
Louisiana Transportation Center
1201 Capitol Road
P.O. Box 94245
Baton Rouge, LA 79084-9245
(225) 379-1323
Paul.Fossier@la.gov

Justin Peltier, P.E.
Senior Engineer, Bridge Design
(225) 379-1069
(225) 379-1786 (fax)
Justin.Peltier@la.gov

MINNESOTA

Michael Elle, P.E.
Design Standards Engineer
Minnesota Department of Transportation
395 John Ireland Blvd, MS 696
St. Paul, MN 55155-1899
(651) 366-4622
michael.elle@state.mn.us

PENNSYLVANIA

Mark R. Burkhead, P.E.
 Standards & Criteria Engineer
 Pennsylvania Department of
 Transportation
 400 North Street
 Harrisburg, PA 17105
 (717) 783-5110
 (717) 705-2379 (fax)
mburkhead@pa.us

TENNESSEE

Jeff Jones,
 Assistant Chief Engineer
 Tennessee Department of Transportation
 Suite 1300
 James K. Polk State Office Building
 Nashville, TN 37243-0348
 (615) 741-2221
Jeff.C.Jones@tn.us

Ali Hangul, P.E.
 Civil Engineering Manager
 (615) 741-0840
 (615) 532-7745 (fax)
Ali.Hangul@tn.us

WASHINGTON

Dave Olson, Chair
 Design Policy, Standards,
 & Research Manager
 Washington State
 Department of Transportation
 P.O. Box 47329
 Olympia, WA 98504-7329
 (360) 705-7952
Olsonda@wsdot.wa.gov

Rhonda Brooks
 Research Manager
 P.O. Box 47372
 Olympia, WA 98504-7372
 (360) 705-7945
Brookrh@wsdot.wa.gov

WEST VIRGINIA

Donna J. Hardy, P.E.
 Safety Programs Engineer
 West Virginia Department of
 Transportation – Traffic Engineering
 Building 5, Room A-550
 1900 Kanawha Blvd E.
 Charleston, WV 25305-0430
 (304) 558-9576
Donna.J.Hardy@wv.gov

**FEDERAL HIGHWAY
 ADMINISTRATION**

Richard B. (Dick) Albin, P.E.
 Safety Engineer
 FHWA Resource Center Safety & Design
 Technical Services Team
 1711 South Capitol Blvd.
 Olympia, WA 98504
 (303) 550-8804
Dick.Albin@dot.gov

William Longstreet
 Highway Engineer
 FHWA Office of Safety Design
 Room E71-107
 1200 New Jersey Avenue, S.E.
 Washington, DC
 (202) 366-0087
Will.Longstreet@dot.gov

**TEXAS TRANSPORTATION
 INSTITUTE**

D. Lance Bullard, Jr., P.E.
 Research Engineer
 Roadside Safety & Physical Security Div.
 Texas Transportation Institute
 Texas A&M University System
 College Station, TX 77843-3135
 (979) 845-6153
L-Bullard@tamu.edu

Roger P. Bligh, Ph.D., P.E.
 Research Engineer
 (979) 845-4377
RBligh@tamu.edu

TABLE OF CONTENTS

<u>Section</u>	<u>Page</u>
1. INTRODUCTION	1
1.1 PROBLEM.....	1
1.2 BACKGROUND	1
1.3 OBJECTIVES/SCOPE OF RESEARCH	1
2. SYSTEM DETAILS	3
2.1 TEST ARTICLE DESIGN AND CONSTRUCTION.....	3
2.2 MATERIAL SPECIFICATIONS	3
2.3 SOIL CONDITIONS	4
3. TEST REQUIREMENTS AND EVALUATION CRITERIA	7
3.1 CRASH TEST MATRIX.....	7
3.2 EVALUATION CRITERIA	7
4. TEST CONDITIONS.....	9
4.1 TEST FACILITY	9
4.2 VEHICLE TOW AND GUIDANCE SYSTEM.....	9
4.3 DATA ACQUISITION SYSTEMS.....	9
4.3.1 Vehicle Instrumentation and Data Processing	9
4.3.2 Anthropomorphic Dummy Instrumentation	10
4.3.3 Photographic Instrumentation and Data Processing	10
5. CRASH TEST 405160-23-2 (<i>MASH</i> TEST NO. 3-11).....	11
5.1 TEST DESIGNATION AND ACTUAL IMPACT CONDITIONS	11
5.2 TEST VEHICLE.....	11
5.3 WEATHER CONDITIONS.....	11
5.4 TEST DESCRIPTION	11
5.5 TEST ARTICLE AND COMPONENT DAMAGE	14
5.6 TEST VEHICLE DAMAGE	14
5.7 OCCUPANT RISK VALUES	14
5.8 ASSESSMENT OF TEST RESULTS	20
5.8.1 Structural Adequacy.....	20
5.8.2 Occupant Risk.....	20
5.8.3 Vehicle Trajectory	21
6. SUMMARY AND CONCLUSIONS	23
6.1 SUMMARY OF RESULTS	23
6.2 CONCLUSIONS.....	23
REFERENCES	25
APPENDIX A. DETAILS OF TEST ARTICLE.....	27
APPENDIX B. SUPPORTING CERTIFICATION DOCUMENTS	31
APPENDIX C. SOIL STRENGTH DOCUMENTATION	33
APPENDIX D. CRASH TEST NO. 405160-23-2.....	35
D1. VEHICLE PROPERTIES AND INFORMATION	35
D2. SEQUENTIAL PHOTOGRAPHS.....	39
D3. VEHICLE ANGULAR DISPLACEMENTS	41
D4. VEHICLE ACCELERATIONS.....	42

LIST OF FIGURES

	<u>Page</u>
Figure 2.1. Layout of the W-Beam Guardrail on Low-Fill Box Culvert.	5
Figure 2.2. W-Beam Guardrail on Low-Fill Box Culvert prior to testing.	6
Figure 5.1. Vehicle/installation geometrics for test 405160-23-2.	12
Figure 5.2. Vehicle before test 405160-23-2.	13
Figure 5.3. Vehicle trajectory path after test 405160-23-2.	15
Figure 5.4. Installation after test 405160-23-2.	16
Figure 5.5. Vehicle after test 405160-23-2.	17
Figure 5.6. Interior of vehicle for test 405160-23-2.	18
Figure 5.7. Summary of results for <i>MASH</i> test 3-11 on the W-Beam Guardrail on Low-Fill Box Culvert.	19
Figure C1. Test day static soil strength documentation.	33
Figure C2. Summary of strong soil test results for establishing installation procedure.	34
Figure D1. Sequential photographs for test 405160-23-2 (overhead and frontal views).	39
Figure D2. Vehicle angular displacements for test 405160-23-2.	41
Figure D3. Vehicle longitudinal accelerometer trace for test 405160-23-2 (accelerometer located at center of gravity).	42
Figure D4. Vehicle lateral accelerometer trace for test 405160-23-2 (accelerometer located at center of gravity).	43
Figure D5. Vehicle vertical accelerometer trace for test 405160-23-2 (accelerometer located at center of gravity).	44
Figure D6. Vehicle longitudinal accelerometer trace for test 405160-23-2 (accelerometer located over rear axle).	45
Figure D7. Vehicle lateral accelerometer trace for test 405160-23-2 (accelerometer located over rear axle).	46
Figure D8. Vehicle vertical accelerometer trace for test 405160-23-2 (accelerometer located over rear axle).	47

LIST OF TABLES

	<u>Page</u>
Table 6.1. Performance evaluation summary for <i>MASH</i> test 3-11 on the W-Beam Guardrail on Low-Fill Box Culvert.	24
Table D1. Vehicle properties for test 405160-23-2.	35
Table D2. Measurements of vehicle vertical CG for test 405160-23-2.	36
Table D3. Exterior crush measurements for test 405160-23-2.	37
Table D4. Occupant compartment measurements for test 405160-23-2.	38

1. INTRODUCTION

1.1 PROBLEM

Guardrail installations frequently must pass over reinforced concrete box culverts used for transverse drainage under highways. In many cases, the depth of fill over the box culvert is very shallow and will not allow the proper embedment of steel or timber guardrail posts. A typical detail in these cases is a shortened W6×9 steel post attached to a steel base plate bolted to the top of the box culvert. An epoxy adhesive anchoring system is sometimes preferred to permit installation of the post without the need to enter the culvert and install a bolt-thru anchoring system.

1.2 BACKGROUND

In 1988, Hirsch and Beggs reported on a study using a W6×9 steel guardrail post with a base plate anchored to a 6-inch thick culvert slab.⁽¹⁾ Static load tests and a full-scale crash test were performed on this design as part of this study. The testing performed on this design was successful with respect to National Cooperative Highway Research Program (NCHRP) *Report 230* performance level 2.⁽²⁾ In 2002, Polivka, Reid, Faller, Rohde, and Sicking reported on a similar design bolted to a box culvert with approximately 9 inches of fill on top of the box culvert.⁽³⁾ This guardrail system utilized a post spacing 3 ft-1-1/2 inch and was designed to meet the Test Level 3 (TL-3) performance criteria found in *NCHRP Report 350*.⁽⁴⁾ Dynamic pendulum and full scale crash testing on this design was also successful.

In Phase I of this pooled fund study, *NCHRP Report 350* test 3-11 was performed to evaluate a guardrail system with standard post spacing (6 ft-3 inches) across a low-fill culvert.⁽⁵⁾ During this test, the W-beam rail element ruptured. The adhesive anchoring system worked as designed with the new W6×9 post and welded baseplate detail. No damage to the deck or failure of the adhesive anchors was observed.

1.3 OBJECTIVES/SCOPE OF RESEARCH

The primary objective of this study was to test and evaluate a guardrail design with standard post spacing for use across low-fill box culverts in accordance with the American Association of State Highway and Transportation Officials (AASHTO) Manual for Assessing Safety Hardware (*MASH*) Test Level 3 (TL-3).⁽⁶⁾ The crash test performed on the W-beam guardrail on low-fill box culvert was in accordance with test 3-11 of *MASH*, which involves the 2270P vehicle (a 5000 lb (1/2 ton) Quad Cab Pickup) impacting the guardrail at a speed of 62 mi/h and an angle of 25 degrees. Included in this report are the details of the installation used in the crash testing, details of the full-scale crash testing, and evaluation of the crash test.

2. SYSTEM DETAILS

2.1 TEST ARTICLE DESIGN AND CONSTRUCTION

The box culvert guardrail installation consisted of a 12 gage W-beam guardrail system supported by W6×9 steel posts anchored to a simulated box culvert. Standard 6-inch × 8-inch × 14-inch long wood blockouts were used to block out the W-beam guardrail from the steel posts. The height of the W-beam guardrail system was 31 inches above finished grade. The posts were spaced on 6 ft-3 inches centers. The W-beam rail splices were located at the midspan of the 6 ft-3 inch post spacing. The posts were anchored to the top of a simulated box culvert slab using the Hilti RE500 epoxy anchoring system. For this test installation, 9 inches of compacted standard soil material was constructed on top of the simulated box culvert slab. The total length of the simulated concrete box culvert slab was 105 ft. The W-beam guardrail system was anchored on each end using ET Plus end terminals. TTI received detailed information regarding the box culvert slab from Mike Elle with Minnesota DOT. These details were incorporated into the box culvert slab installation.

The W6×9 steel posts were welded to 12-inch × 12-inch × 7/8-inch thick base plates. The total length of the posts was 40 1/8 inches. Each steel post with base plate was anchored to the 9-inch thick simulated box culvert slab using four 7/8-inch diameter A193 Super HAS all-threaded rods, 8 1/2 inches in length. These threaded rods were embedded approximately 6 inches in the box culvert slab and were anchored using the HILTI RE500 Epoxy Anchoring System.

The simulated box culvert slab tested for this project was 105 ft in length by 75 inches in width by 9 inches thick. The fill height constructed on top of the box culvert slab was approximately 9 inches. A 9-inch high by 10-inch wide concrete headwall was constructed on the field side edge of the box culvert slab. The W6×9 steel posts were located 28 inches from the field side edge of the simulated box culvert slab. Transverse steel reinforcement in the slab consisted of #3 bars spaced at 12 inches on centers in the top and bottom mats. Longitudinal steel reinforcement in the bottom mat consisted of #5 bars spaced 4 1/2 inches on centers. Longitudinal steel reinforcement in the top mat consisted of #3 bars spaced 6 inches on centers. Transverse reinforcement in the 9-inch high headwall consisted of #3 stirrups spaced at 12 inches on centers. Four #3 longitudinal steel bars were evenly spaced inside the stirrup reinforcement in the headwall. Please refer to figure 2.1, figure 2.2, and Appendix A for additional information on the box culvert slab test installation.

2.2 MATERIAL SPECIFICATIONS

The specified concrete strength used in the box culvert slab was 5000 psi compressive strength, and the strength of the concrete on the day of the test (at 29 days of age) was 5586 psi. Materials used for this installation are summarized in Appendix B. For further details of the certification documentation for these materials, please contact Texas Transportation Institute (TTI) Proving Ground for documents on file.

2.3 SOIL CONDITIONS

As stated previously, the test installation was installed on a simulated low-fill box culvert with 9 inches of cover with standard soil conforming to AASHTO standard specifications for “Materials for Aggregate and Soil Aggregate Subbase, Base and Surface Courses”, designated M147-65(2004), grading B.

In accordance with Appendix B of *MASH*, soil strength was measured the day of the crash test (see Appendix C, figure C1). During the installation of the end terminals used to anchor each end of the box culvert guardrail, two standard W6×16 test posts were installed in the immediate vicinity for soil strength testing. These test posts were installed for soil strength testing of the posts used in the construction of the end terminals. These W6×16 test posts were installed using the same construction materials and procedures as the posts used in the end terminals. The end terminal posts and W6×16 test posts were installed in standard soil.

As determined in the tests shown in Appendix C, figure C2, the minimum post load required for deflections at 5 inches, 10 inches, and 15 inches, measured at a height of 25 inches, is 3940 lb, 5500 lb, and 6540 lb, respectively (90 percent of static load for the initial standard installation). On the day of the test, November 11, 2011, load on the post at deflections of 5 inches, 10 inches, and 15 inches was 6515 lbf, 6606 lbf, and 6303 lbf, respectively. The strength of the backfill material did not meet minimum strength requirements at 15 inches. However, only the terminal section was installed in soil, and the section being tested was on the concrete box culvert. Therefore, the full-scale crash test was performed.

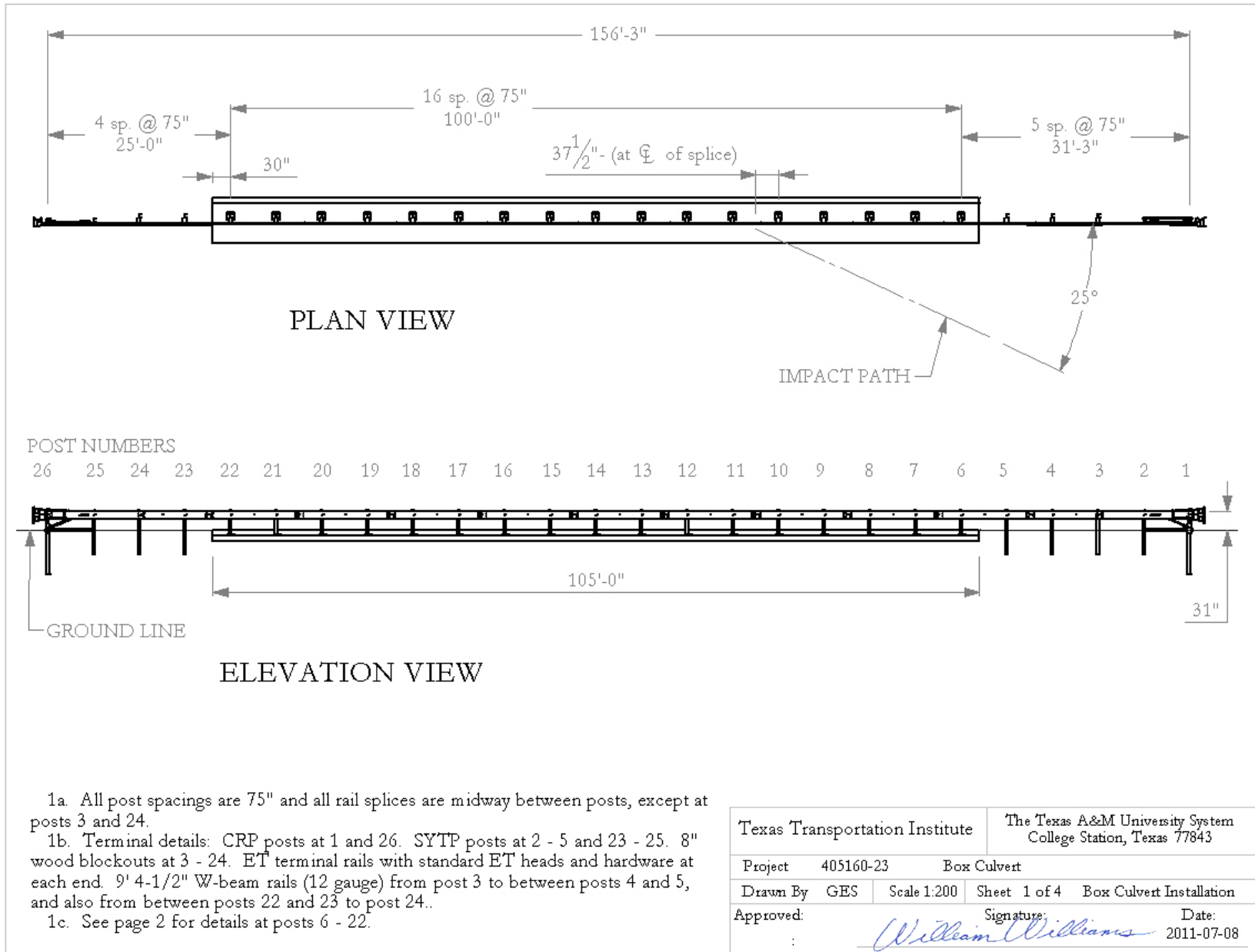

Figure 2.1. Layout of the W-Beam Guardrail on Low-Fill Box Culvert.



Figure 2.2. W-Beam Guardrail on Low-Fill Box Culvert prior to testing.

3. TEST REQUIREMENTS AND EVALUATION CRITERIA

3.1 CRASH TEST MATRIX

According to *MASH*, two tests are recommended to evaluate longitudinal barriers to test level three (TL-3) as described below.

***MASH* Test Designation 3-10:** A 2425 lb vehicle impacting the length of need section at a speed of 62 mi/h and an angle of 25 degrees.

***MASH* Test Designation 3-11:** A 5000 lb pickup truck impacting the length of need section at a speed of 62 mi/h and an angle of 25 degrees.

MASH test 3-11 was performed and is reported herein.

The crash test and data analysis procedures were in accordance with guidelines presented in *MASH*. Chapter 4 presents brief descriptions of these procedures.

3.2 EVALUATION CRITERIA

The crash test was evaluated in accordance with the criteria presented in *MASH*. The performance of the W-Beam Guardrail on Low-Fill Box Culvert is evaluated on the basis of three factors: structural adequacy, occupant risk, and post impact vehicle trajectory. Structural adequacy is evaluated upon the ability of the W-Beam Guardrail on Low-Fill Box Culvert to contain and redirect the vehicle, or bring the vehicle to a controlled stop in a predictable manner. Occupant risk criteria evaluates the potential risk of hazard to occupants in the impacting vehicle, and to some extent other traffic, pedestrians, or workers in construction zones, if applicable. Post impact vehicle trajectory is assessed to determine potential for secondary impact with other vehicles or fixed objects, creating further risk of injury to occupants of the impacting vehicle and/or risk of injury to occupants in other vehicles. The appropriate safety evaluation criteria from table 5.1 of *MASH* were used to evaluate the crash test reported herein, and are listed in further detail under the assessment of the crash test.

4. TEST CONDITIONS

4.1 TEST FACILITY

The full-scale crash test reported herein was performed at Texas Transportation Institute (TTI) Proving Ground. TTI Proving Ground is an International Standards Organization (ISO) 17025 accredited laboratory with American Association for Laboratory Accreditation (A2LA) Mechanical Testing certificate 2821.01. The full-scale crash test was performed according to TTI Proving Ground quality procedures and according to the *MASH* guidelines and standards.

The test facilities at the TTI Proving Ground consist of a 2000 acre (809-hectare) complex of research and training facilities situated 10 miles (16 km) northwest of the main campus of Texas A&M University. The site, formerly an Air Force Base, has large expanses of concrete runways and parking aprons well suited for experimental research and testing in the areas of vehicle performance and handling, vehicle-roadway interaction, durability and efficacy of highway pavements, and safety evaluation of roadside safety hardware. The site selected for the installation of the W-Beam Guardrail on Low-Fill Box Culvert is along the edge of a wide out-of-service apron. The apron consists of an unreinforced jointed concrete pavement in 12.5 ft × 15 ft blocks nominally 8-12 inches deep. The aprons are over 50 years old and the joints have some displacement, but are otherwise flat and level.

4.2 VEHICLE TOW AND GUIDANCE SYSTEM

The test vehicle was towed into the test installation using a steel cable guidance and reverse tow system. A steel cable for guiding the test vehicle was tensioned along the path, anchored at each end, and threaded through an attachment to the front wheel of the test vehicle. An additional steel cable was connected to the test vehicle, passed around a pulley near the impact point, through a pulley on the tow vehicle, and then anchored to the ground such that the tow vehicle moved away from the test site. A two-to-one speed ratio between the test and tow vehicle existed with this system. Just prior to impact with the installation, the test vehicle was released to be free-wheeling and unrestrained. The vehicle remained free-wheeling, i.e., no steering or braking inputs.

4.3 DATA ACQUISITION SYSTEMS

4.3.1 Vehicle Instrumentation and Data Processing

The test vehicle was instrumented with a self-contained, on-board data acquisition system. The signal conditioning and acquisition system is a 16-channel, Tiny Data Acquisition System (TDAS) Pro produced by Diversified Technical Systems, Inc. The accelerometers, that measure the x, y, and z axis of vehicle acceleration, are strain gauge type with linear millivolt output proportional to acceleration. Angular rate sensors, measuring vehicle roll, pitch, and yaw rates, are ultra small size, solid state units designs for crash test service. The TDAS Pro hardware and software conform to the latest SAE J211, Instrumentation for Impact Test. Each of

the 16 channels is capable of providing precision amplification, scaling and filtering based on transducer specifications and calibrations. During the test, data are recorded from each channel at a rate of 10,000 values per second with a resolution of one part in 65,536. Once recorded, the data are backed up inside the unit by internal batteries should the primary battery cable be severed. Initial contact of the pressure switch on the vehicle bumper provides a time zero mark as well as initiating the recording process. After each test, the data are downloaded from the TDAS Pro unit into a laptop computer at the test site. The raw data are then processed by the Test Risk Assessment Program (TRAP) software to produce detailed reports of the test results. Each of the TDAS Pro units are returned to the factory annually for complete recalibration. Accelerometers and rate transducers are also calibrated annually with traceability to the National Institute for Standards and Technology. Acceleration data is measured with an expanded uncertainty of $\pm 1.7\%$ at a confidence fracture of 95% ($k=2$).

TRAP uses the data from the TDAS Pro to compute occupant/compartment impact velocities, time of occupant/compartment impact after vehicle impact, and the highest 10-millisecond (ms) average ridedown acceleration. TRAP calculates change in vehicle velocity at the end of a given impulse period. In addition, maximum average accelerations over 50-ms intervals in each of the three directions are computed. For reporting purposes, the data from the vehicle-mounted accelerometers are filtered with a 60-Hz digital filter, and acceleration versus time curves for the longitudinal, lateral, and vertical directions are plotted using TRAP.

TRAP uses the data from the yaw, pitch, and roll rate transducers to compute angular displacement in degrees at 0.0001-s intervals and then plots yaw, pitch, and roll versus time. These displacements are in reference to the vehicle-fixed coordinate system with the initial position and orientation of the vehicle-fixed coordinate systems being initial impact. Rate of rotation data is measured with an expanded uncertainty of $\pm 0.7\%$ at a confidence factor of 95% ($k=2$).

4.3.2 Anthropomorphic Dummy Instrumentation

Use of a dummy in the 2270P vehicle is optional according to *MASH*, and there was no dummy used in the test.

4.3.3 Photographic Instrumentation and Data Processing

Photographic coverage of the test included three high-speed cameras: one overhead with a field of view perpendicular to the ground and directly over the impact point; one placed behind the installation at an angle; and a third placed to have a field of view parallel to and aligned with the installation at the downstream end. A flashbulb activated by pressure-sensitive tape switches was positioned on the impacting vehicle to indicate the instant of contact with the installation and was visible from each camera. The films from these high-speed cameras were analyzed on a computer-linked motion analyzer to observe phenomena occurring during the collision and to obtain time-event, displacement, and angular data. A mini-DV camera and still cameras recorded and documented conditions of the test vehicle and installation before and after the test.

5. CRASH TEST 405160-23-2 (MASH TEST NO. 3-11)

5.1 TEST DESIGNATION AND ACTUAL IMPACT CONDITIONS

MASH test 3-11 involves a 2270P vehicle weighing 5000 lb \pm 100 lb and impacting the box culvert guardrail at a speed of 62.2 mi/h \pm 2.5 mi/h and an angle of 25 degrees \pm 1.5 degrees. The target impact point was 5 ft-3 inches upstream of post 12. The 2003 Dodge Ram 1500 Quad Cab pickup truck used in the test weighed 5005 lb and the actual impact speed and angle were 62.9 mi/h and 26.1 degrees, respectively. The actual impact point was 5 ft-4 inches upstream of post 12. Impact severity was 128.1 kip-ft, which was 11 percent greater than the target.

5.2 TEST VEHICLE

The 2003 Dodge Ram 1500 Quad Cab pickup truck, shown in figures 5.1 and 5.2, was used for the crash test. Test inertia weight of the vehicle was 5005 lb, and its gross static weight was 5005 lb. The height to the lower edge of the vehicle front bumper was 13.5 inches, and the height to the upper edge of the front bumper was 26.0 inches. The height to the center of gravity was 28.0 inches. Additional dimensions and information on the vehicle are given in Appendix D, tables D1 and D2. The vehicle was directed into the installation using the cable reverse tow and guidance system, and was released to be free-wheeling and unrestrained just prior to impact.

5.3 WEATHER CONDITIONS

The crash test was performed the morning of November 11, 2011. Weather conditions at the time of testing were: Wind speed: 8 mi/h; wind direction: 191 degrees with respect to the vehicle (vehicle was traveling in a southwesterly direction); temperature: 65°F; relative humidity: 26 percent.

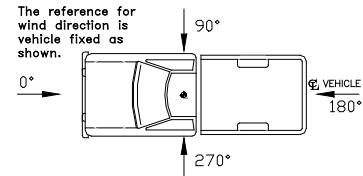

5.4 TEST DESCRIPTION

The 2003 Dodge Ram 1500 pickup truck, traveling at an impact speed of 62.9 mi/h, impacted the W-Beam Guardrail on Low-Fill Box Culvert 5 ft-4 inches upstream of post 12 at an angle of 26.1 degrees. At approximately 0.019 s, the vehicle began to redirect, and at 0.043 s, post 12 began to deflect towards the field side. Posts 13, 14, 15, 16, and 17 began to deflect towards the field side at 0.090 s, 0.117 s, 0.178 s, 0.215 s, and 0.303 s, respectively. At 0.322 s, the vehicle was traveling parallel with the guardrail at a speed of 44.4 mi/h. Maximum deflection of the rail element was 45.1 inches at 0.400 s. At 0.644 s, the vehicle lost contact with the rail element and was traveling at an exit speed and angle of 32.2 mi/h and 10.9 degrees, respectively. Brakes on the vehicle were not applied, and the vehicle came to rest 123 ft downstream of impact and 37 ft towards the field side. Sequential photographs of the test period are shown in Appendix D, figure D2.



Figure 5.1. Vehicle/installation geometrics for test 405160-23-2.



Figure 5.2. Vehicle before test 405160-23-2.

5.5 TEST ARTICLE AND COMPONENT DAMAGE

Figures 5.3 and 5.4 shows damage to the W-Beam Guardrail on Low-Fill Box Culvert. Post 1 was pulled downstream 1 inch. Post 11 was deflected toward the field side 0.5 inch at ground level and rotated 30 degrees clockwise. At post 12, the W-beam rail element was torn from the lower edge to half the height of the rail element. Posts 12 through 16 rotated clockwise and were leaning downstream 50 degrees, and the W-beam rail element and blockouts released from the posts. Post 17 was leaning downstream 40 degrees and the blockout separated from the post. Post 18 was leaning downstream 5 degrees. The top half of the cable release post (CRP) at post 26 released at the base, but the head remained on the post. The ground piece of the CRP was pulled upstream 2 inches. Working width during the test was 49.6 inches, dynamic deflection of the W-beam rail element was 45.1 inches.

5.6 TEST VEHICLE DAMAGE

Damage to the vehicle is shown in figure 5.5. The right upper and lower ball joints were pulled out and the right upper and lower A-arms and right frame rail were deformed. Also damaged were the front bumper, grill, right front fender, right front and rear doors, right front tire and wheel rim, right rear exterior bed, right rear tire and wheel rim, and the rear bumper. Maximum exterior crush to the vehicle was 14.0 inches in the side plane at the right front corner at bumper height. No measureable occupant compartment deformation occurred. Photographs of the interior of the vehicle are shown in figure 5.6. Exterior vehicle crush and occupant compartment measurements are shown in Appendix D, tables D3 and D4.

5.7 OCCUPANT RISK VALUES

Data from the accelerometer, located at the vehicle center of gravity, were digitized for evaluation of occupant risk. In the longitudinal direction, the occupant impact velocity was 15.4 ft/s at 0.137 s, the highest 0.010-s occupant ridedown acceleration was 5.3 Gs from 0.428 to 0.438 s, and the maximum 0.050-s average acceleration was -4.7 Gs between 0.056 and 0.106 s. In the lateral direction, the occupant impact velocity was 14.4 ft/s at 0.137 s, the highest 0.010-s occupant ridedown acceleration was 6.4 Gs from 0.283 to 0.293 s, and the maximum 0.050-s average was -4.3 Gs between 0.202 and 0.252 s. Theoretical Head Impact Velocity (THIV) was 22.1 km/h or 6.1 m/s at 0.131 s; Post-Impact Head Decelerations (PHD) was 6.7 Gs between 0.283 and 0.293 s; and Acceleration Severity Index (ASI) was 0.58 between 0.072 and 0.122 s. These data and other pertinent information from the test are summarized in figure 5.7. Vehicle angular displacements and accelerations versus time traces are presented in Appendix D, figures D2 through D8.



Figure 5.3. Vehicle trajectory path after test 405160-23-2.



Figure 5.4. Installation after test 405160-23-2.



Figure 5.5. Vehicle after test 405160-23-2.



Before Test
After Test



Figure 5.6. Interior of vehicle for test 405160-23-2.

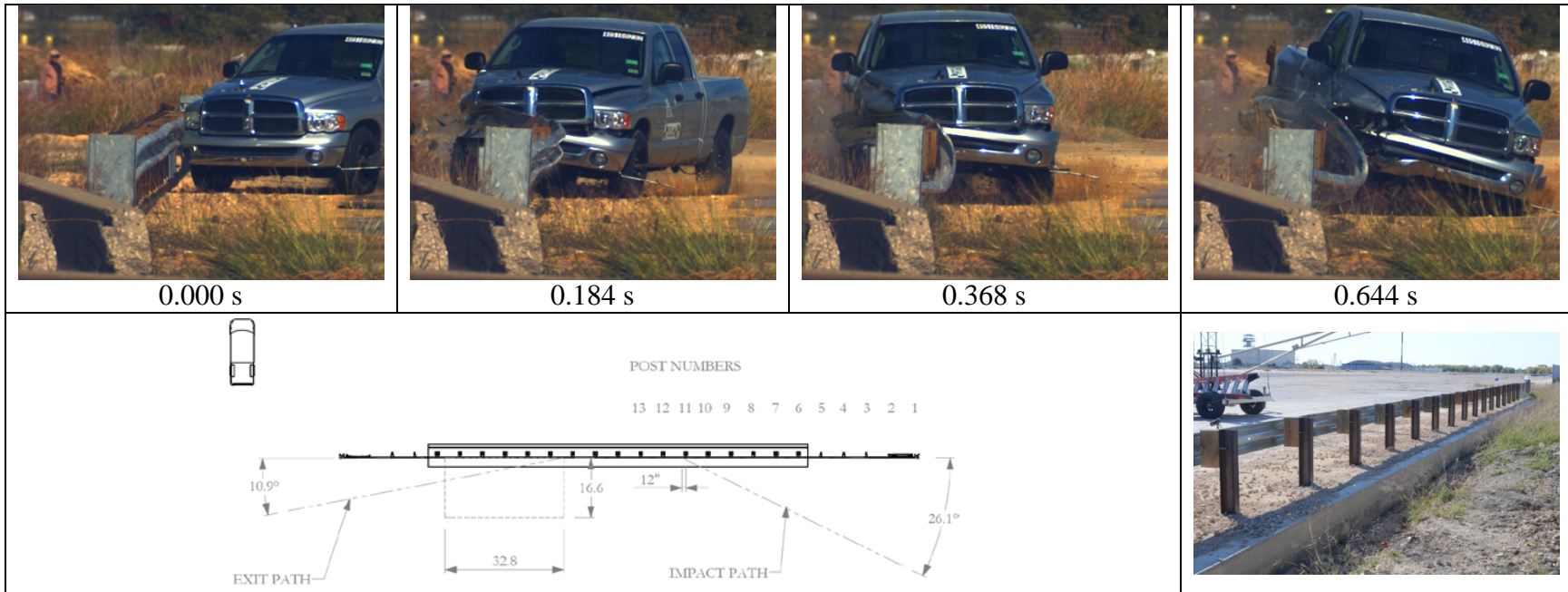

19

General Information

Test Agency Texas Transportation Institute (TTI)
 Test Standard Test No. MASH Test 3-11
 TTI Test No. 405160-23-2
 Date November 11, 2011

Test Article

Type Longitudinal Barrier
 Name W-Beam Guardrail on Low-Fill Box Culvert
 Installation Length 105 ft
 Material or Key Elements 12 gage W-beam guardrail system on W6x9 steel posts anchored to simulated concrete box culvert

Soil Type and Condition

..... Concrete box culvert, dry

Test Vehicle

Type/Designation 2270P
 Make and Model 2003 Dodge Ram 1500
 Curb 4900 lb
 Test Inertial 5005 lb
 Dummy No dummy
 Gross Static 5005 lb

Impact Conditions

Speed 62.9 mi/h
 Angle 26.1 degrees
 Location/Orientation 5.5 ft upstream of the post 12

Impact Severity

..... 128.1 kip-ft

Exit Conditions

Speed 32.2 mi/h
 Angle 10.9 degrees

Occupant Risk Values

Impact Velocity
 Longitudinal 15.4 ft/s
 Lateral 14.4 ft/s
 Ridedown Accelerations
 Longitudinal 5.3 G
 Lateral 6.4 G
 THIV 22.1 km/h
 PHD 6.7 G
 ASI 0.58
 Max. 0.050-s Average
 Longitudinal -4.7 G
 Lateral -4.3 G
 Vertical 2.0 G

Post-Impact Trajectory

Stopping Distance 123 ft downstream
 37 ft twds field side

Vehicle Stability

Maximum Yaw Angle 37 degrees
 Maximum Pitch Angle 11 degrees
 Maximum Roll Angle 9 degrees
 Vehicle Snagging No
 Vehicle Pocketing No

Test Article Deflections

Dynamic 3.8 ft
 Permanent Terminal detached
 Working Width 4.1 ft

Vehicle Damage

VDS 01RFQ4
 CDC 01FREW3
 Max. Exterior Deformation 14.0 inches
 OCDI RF0000000
 Max. Occupant Compartment Deformation Nil

Figure 5.7. Summary of results for MASH test 3-11 on the W-Beam Guardrail on Low-Fill Box Culvert.

5.8 ASSESSMENT OF TEST RESULTS

An assessment of the test was made based on the following applicable *MASH* safety evaluation criteria.

5.8.1 Structural Adequacy

- A. *Test article should contain and redirect the vehicle or bring the vehicle to a controlled stop; the vehicle should not penetrate, underride, or override the installation although controlled lateral deflection of the test article is acceptable.*

Results: The W-Beam Guardrail on Low-Fill Box Culvert contained and redirected the 2270P vehicle. The vehicle did not penetrate, underride, or override the installation, however, the rail element was torn half the width at post 12. Maximum dynamic deflection during the test was 45.1 inches. (PASS)

5.8.2 Occupant Risk

- D. *Detached elements, fragments, or other debris from the test article should not penetrate or show potential for penetrating the occupant compartment, or present an undue hazard to other traffic, pedestrians, or personnel in a work zone. Deformation of, or intrusions into, the occupant compartment should not exceed limits set forth in Section 5.3 and Appendix E of MASH. (roof ≤ 4.0 inches; windshield = ≤ 3.0 inches; side windows = no shattering by test article structural member; wheel/foot well/toe pan ≤ 9.0 inches; forward of A-pillar ≤ 12.0 inches; front side door area above seat ≤ 9.0 inches; front side door below seat ≤ 12.0 inches; floor pan/transmission tunnel area ≤ 12.0 inches).*

Results: Several blockouts separated from the installation. However, none of these detached elements penetrated or showed potential for penetrating the occupant compartment, nor to present undue hazard to others in the area. (PASS)
No occupant compartment deformation occurred. (PASS)

- F. *The vehicle should remain upright during and after collision. The maximum roll and pitch angles are not to exceed 75 degrees.*

Results: The 2270P vehicle remained upright during and after the collision event. Maximum roll and pitch angles were 9 degrees and 11 degrees, respectively. (PASS)

- H. *Occupant impact velocities should satisfy the following:*

<u>Longitudinal and Lateral Occupant Impact Velocity</u>	
<u>Preferred</u>	<u>Maximum</u>
30 ft/s	40 ft/s

Results: Longitudinal occupant impact velocity was 15.4 ft/s, and lateral occupant impact velocity was 14.4 ft/s. (PASS)

- I. *Occupant ridedown accelerations should satisfy the following:*
Longitudinal and Lateral Occupant Ridedown Accelerations

<u>Preferred</u>	<u>Maximum</u>
15.0 Gs	20.49 Gs

Results: Longitudinal ridedown acceleration was 5.3 G, and lateral ridedown acceleration was 6.4 G. (PASS)

5.8.3 Vehicle Trajectory

For redirective devices, the vehicle shall exit the barrier within the exit box (not less than 32.8 ft).

Result: The 2270P vehicle exited within the exit box specifications. (PASS)

6. SUMMARY AND CONCLUSIONS

6.1 SUMMARY OF RESULTS

The W-Beam Guardrail on Low-Fill Box Culvert contained and redirected the 2270P vehicle. The vehicle did not penetrate, underride, or override the installation, however, the rail element was torn half the width at post 12. Maximum dynamic deflection during the test was 45.1 inches. Several blockouts separated from the installation. However, none of these detached elements penetrated or showed potential for penetrating the occupant compartment, nor to present undue hazard to others in the area. No occupant compartment deformation occurred. The 2270P vehicle remained upright during and after the collision event. Maximum roll and pitch angles were -9 degrees and -11 degrees, respectively. Occupant risk factors were within the limits specified in *MASH*. The 2270P vehicle exited within the exit box specifications.

6.2 CONCLUSIONS

The W-Beam Guardrail on Low-Fill Box Culvert performed acceptably according to the specifications for *MASH* test 3-11, as shown in table 6.1.

Table 6.1. Performance evaluation summary for MASH test 3-11 on the W-Beam Guardrail on Low-Fill Box Culvert.

Test Agency: Texas Transportation Institute

Test No.: 405160-23-2

Test Date: 2011-11-11

MASH Test 3-11 Evaluation Criteria	Test Results	Assessment
<p>Structural Adequacy</p> <p>A. <i>Test article should contain and redirect the vehicle or bring the vehicle to a controlled stop; the vehicle should not penetrate, underride, or override the installation although controlled lateral deflection of the test article is acceptable</i></p>	<p>The W-Beam Guardrail on Low-Fill Box Culvert contained and redirected the 2270P vehicle. The vehicle did not penetrate, underride, or override the installation, however, the rail element was torn half the width at post 12. Maximum dynamic deflection during the test was 45.1 inches.</p>	<p>Pass</p>
<p>Occupant Risk</p> <p>D. <i>Detached elements, fragments, or other debris from the test article should not penetrate or show potential for penetrating the occupant compartment, or present an undue hazard to other traffic, pedestrians, or personnel in a work zone.</i></p>	<p>Several blockouts separated from the installation. However, none of these detached elements penetrated or showed potential for penetrating the occupant compartment, nor to present undue hazard to others in the area.</p>	<p>Pass</p>
<p><i>Deformations of, or intrusions into, the occupant compartment should not exceed limits set forth in Section 5.3 and Appendix E of MASH.</i></p>	<p>No occupant compartment deformation occurred.</p>	<p>Pass</p>
<p>F. <i>The vehicle should remain upright during and after collision. The maximum roll and pitch angles are not to exceed 75 degrees.</i></p>	<p>The 2270P vehicle remained upright during and after the collision event. Maximum roll and pitch angles were 9 degrees and 11 degrees, respectively.</p>	<p>Pass</p>
<p>H. <i>Longitudinal and lateral occupant impact velocities should fall below the preferred value of 30 ft/s, or at least below the maximum allowable value of 40 ft/s.</i></p>	<p>Longitudinal occupant impact velocity was 15.4 ft/s, and lateral occupant impact velocity was 14.4 ft/s.</p>	<p>Pass</p>
<p>I. <i>Longitudinal and lateral occupant ridedown accelerations should fall below the preferred value of 15.0 Gs, or at least below the maximum allowable value of 20.49 Gs.</i></p>	<p>Longitudinal ridedown acceleration was 5.3 G, and lateral ridedown acceleration was 6.4 G.</p>	<p>Pass</p>
<p>Vehicle Trajectory</p> <p><i>For redirective devices, the vehicle shall exit the barrier within the exit box (not less than 32.8 ft).</i></p>	<p>The 2270P vehicle exited within the exit box specifications</p>	<p>Pass</p>

REFERENCES

1. T. J. Hirsch and D. Beggs, "Use of Guardrails on Low Fill Bridge Length Culverts," *Research Report 405-2F*, Texas Transportation Institute, Texas A&M University, College Station, TX, 1987.
2. J. D. Michie, *Recommended Procedures for the Safety Performance Evaluation of Highway Appurtenances*, National Cooperative Highway Research Program Report 230, Transportation Research Board, National Research Council, Washington, D.C., March 1981.
3. K. A. Polivka, D. L. Sicking, J. D. Reid, R. K. Faller, J. R. Rohde, and J. C. Holloway, "NCHRP 350 Development and Testing of a Guardrail Connection to Low-Fill Culverts," NwRSF Research Report No. TRP-03-114-02, Midwest States' Regional Pooled Fund Program, Midwest Roadside, November 2002.
4. H. E. Ross, Jr., D. L. Sicking, R. A. Zimmer and J. D. Michie, *Recommended Procedures for the Safety Performance Evaluation of Highway Features*, National Cooperative Highway Research Program Report 350, Transportation Research Board, National Research Council, Washington, D.C., 1993.
5. W. F. Williams, Roger P. Bligh, D. Lance Bullard, Jr., and W. L. Menges, "Crash Testing and Evaluation of W-Beam Guardrail on Box Culvert," Test Report No. 405160-5-1, Texas Transportation Institute in cooperation with the Roadside Safety Research Program Pooled Fund Study, College Station, TX, August 2008.
6. AASHTO, *Manual for Assessing Safety Hardware*, American Association of State Highway and Transportation Officials, Washington, D.C., 2009.

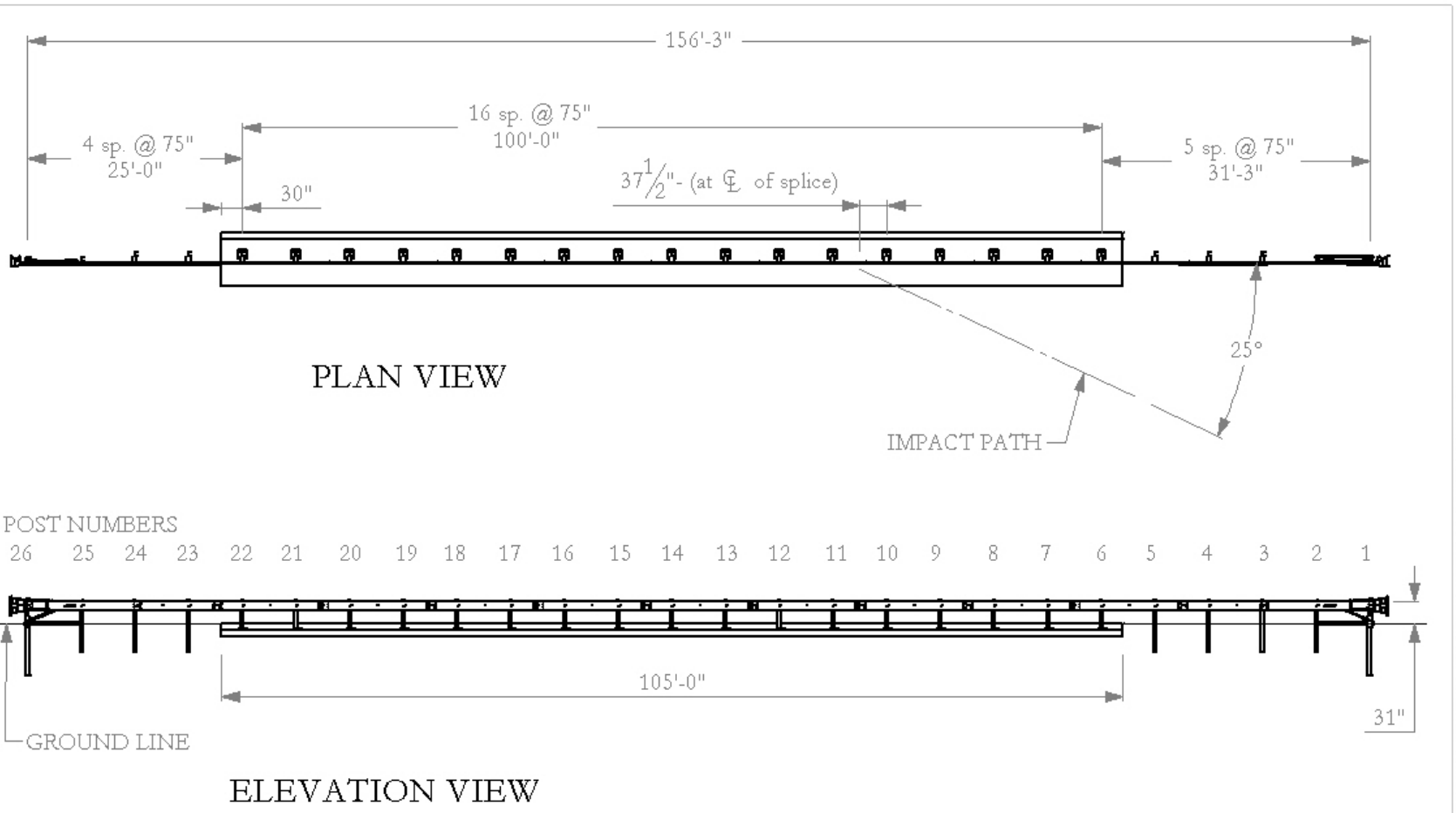

- 1a. All post spacings are 75" and all rail splices are midway between posts, except at posts 3 and 24.
- 1b. Terminal details: CRP posts at 1 and 26. SYTP posts at 2 - 5 and 23 - 25. 8" wood blockouts at 3 - 24. ET terminal rails with standard ET heads and hardware at each end. 9' 4-1/2" W-beam rails (12 gauge) from post 3 to between posts 4 and 5, and also from between posts 22 and 23 to post 24..
- 1c. See page 2 for details at posts 6 - 22.

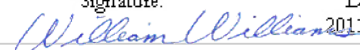
Texas Transportation Institute		The Texas A&M University System College Station, Texas 77843	
Project	405160-23	Box Culvert	
Drawn By	GES	Scale	1:200
Sheet	1 of 4	Box Culvert Installation	
Approved:	Signature:		Date:
			2011-07-08

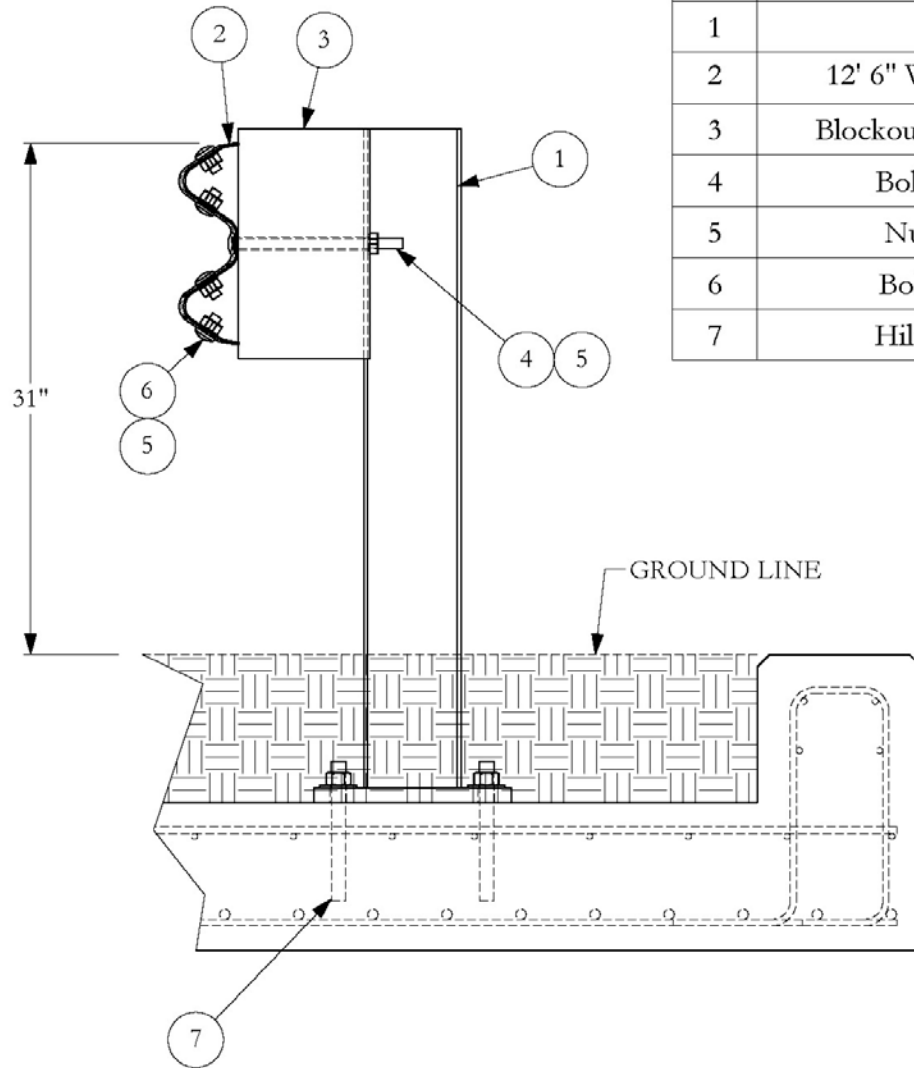

#	PART NUMBER	QTY.	ARTBA
1	Box Culvert Post	17	
2	12' 6" W-Beam, 4- space 12 gauge	9	RWM02a
3	Blockout, 8-inch W-beam Routered	17	PDB01b
4	Bolt, Button-head 10 inch	17	FBB03
5	Nut, Recessed Guardrail	89	FBB
6	Bolt, Button-head 1-1/4"	72	FBB01
7	Hilti Anchor (see note 2a)	68	

2a. HAS-E $\varnothing 7/8$ (cut off to 8-1/2" long) with washer and nut. Installed with Hilti RE500 epoxy according to label directions with minimum 6" embedment.

Texas Transportation Institute		The Texas A&M University System College Station, Texas 77843	
Project	405160-23	Box Culvert	
Drawn By	GES	Scale	1:10
Sheet	2 of 4	Box Culvert Length of Need	

T:\2010-2011\405160-PooledFund\23 Box Culvert\Drafting\Drawings\405160-23 Drawing

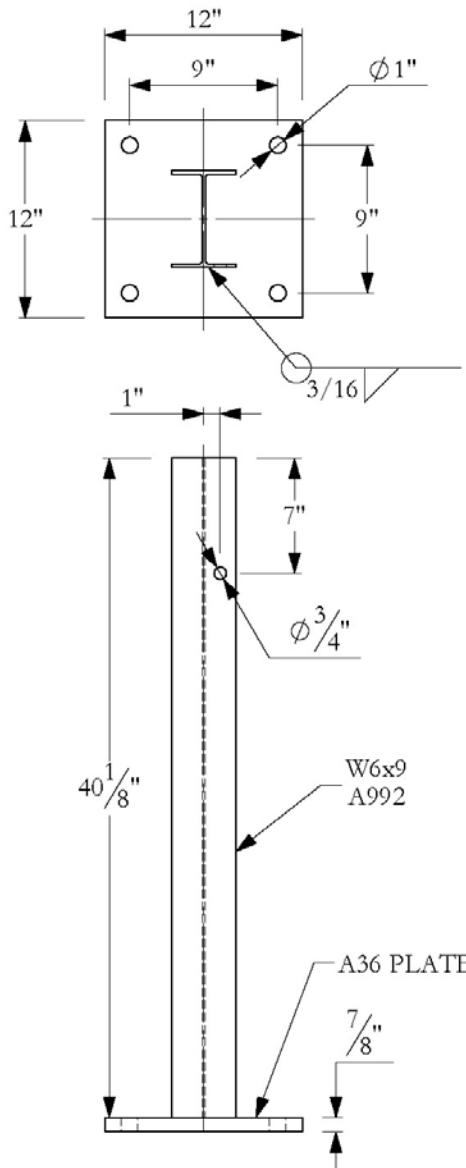

1 BOX CULVERT POST

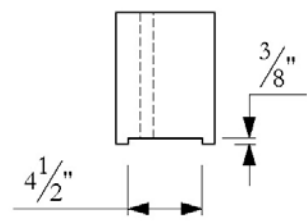
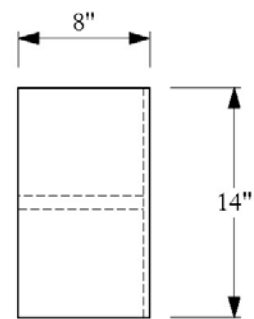
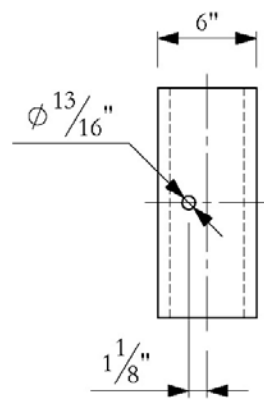

3 8" WOOD BLOCKOUT

Texas Transportation Institute		The Texas A&M University System College Station, Texas 77843	
Project	405160-23	Box Culvert	
Drawn By	GES	Scale	1:10
Sheet	3 of 4	Post and Blockout Details	

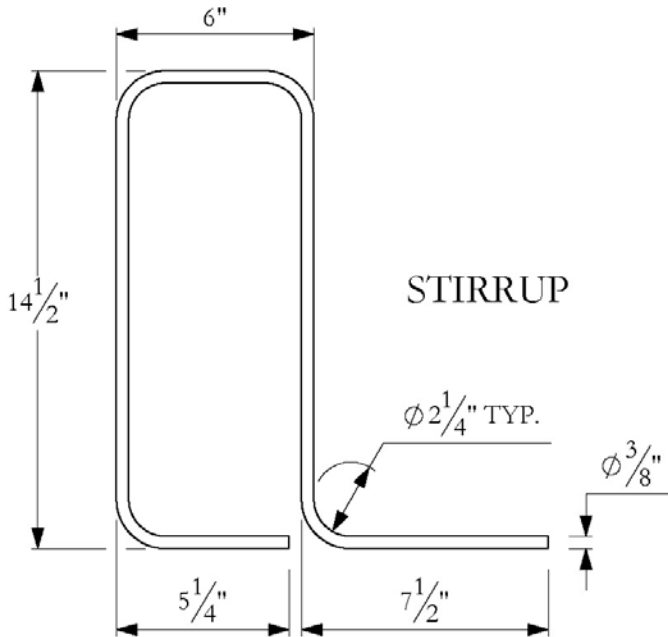
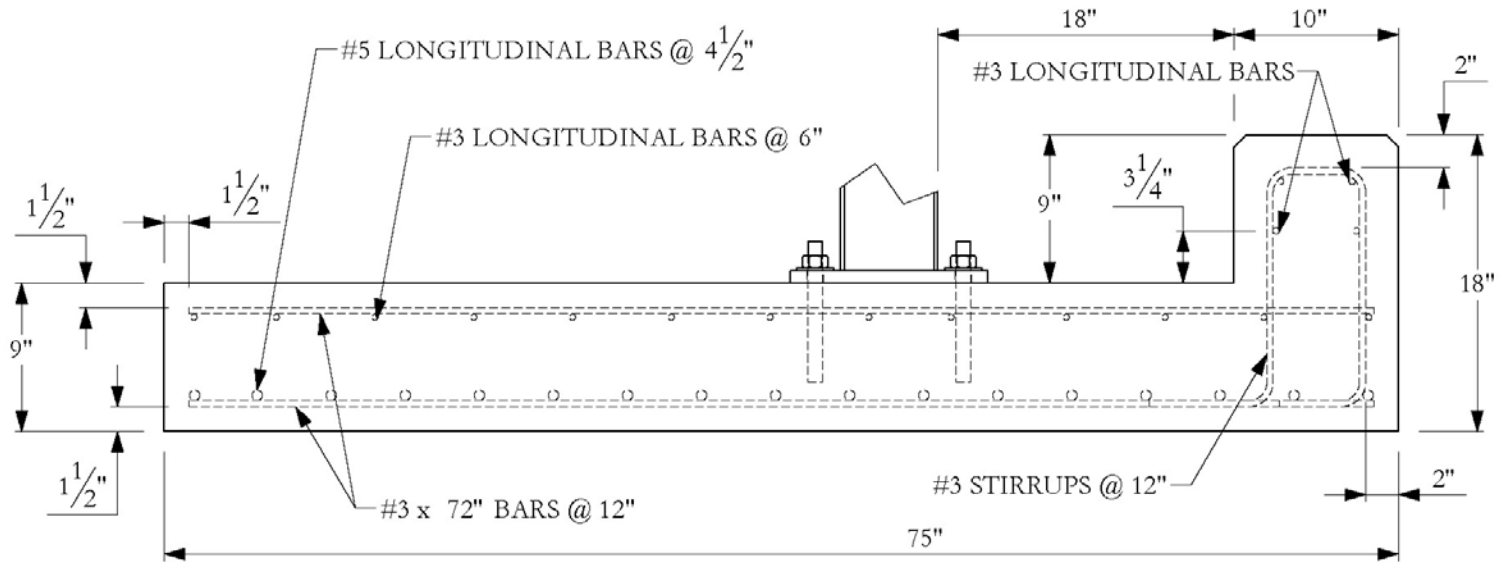

CONCRETE AND REBAR
END VIEW

- 4a. Chamfer top edges of curb 3/4".
- 4b. Concrete strength is 5000 psi.
- 4c. Rebar laps are 20" for #3 bars and 30" for #5 bars.

Texas Transportation Institute		The Texas A&M University System College Station, Texas 77843	
Project	405160-23	Box Culvert	
Drawn By	GES	Scale	1:10
Sheet		4 of 4	Concrete and Rebar Details

T:\2010-2011\405160-PooledFund\23 Box Culvert\Drafting\Drawings\405160-23 Drawing

MATERIAL USED

TEST NUMBER 405160-23-2
 TEST NAME Box Culvert
 DATE 2011-11-11

DATE RECEIVED	ITEM NUMBER	DESCRIPTION	SUPPLIER	HEAT #
2011-08-10	Parts-10	Box Culvert	Trinity Industries	see attached
2011-08-08	Plate 0.8750-01	4' x 8' x 7/8" A36	Mack Bolt & Steel	several - see list
2011-07-11	Rebar 03-05	3/8" x 20' grd 60	CMC-Sheplers	3024692
2011-07-11	Rebar 05-10	5/8" x 20' grd 60	CMC-Sheplers	3024925
2011-08-08	W-section-01	W6x9 x 40'	Mack Bolt & Steel	22603050
2010-11-29	W-beam 04	12 ga. 4-space	Trinity Industries	several - see list

W-beam 04 used from between posts 4 and 5 to between posts 12 and 13 to replace rail damaged in previous test.

DESCRIPTION	# REC.
4 sp. W-beam	10
ET Anchor rail	2
Cable Anchor Bracket	2
Anchor Cable	2
Guardrail Nuts	137
1-1/4" long guardrail bolt	112
10" long guardrail bolt	25
1" flat washer	4
1" hex nut A563	4
6x8x14 routed blackout	25
9'4-1/2" W-beam	2

FOR FURTHER DETAILS ON THE CERTIFICATION DOCUMENTS FOR THIS TEST, PLEASE CONTACT TTI PROVING GROUND FOR DOCUMENTS ON FILE.

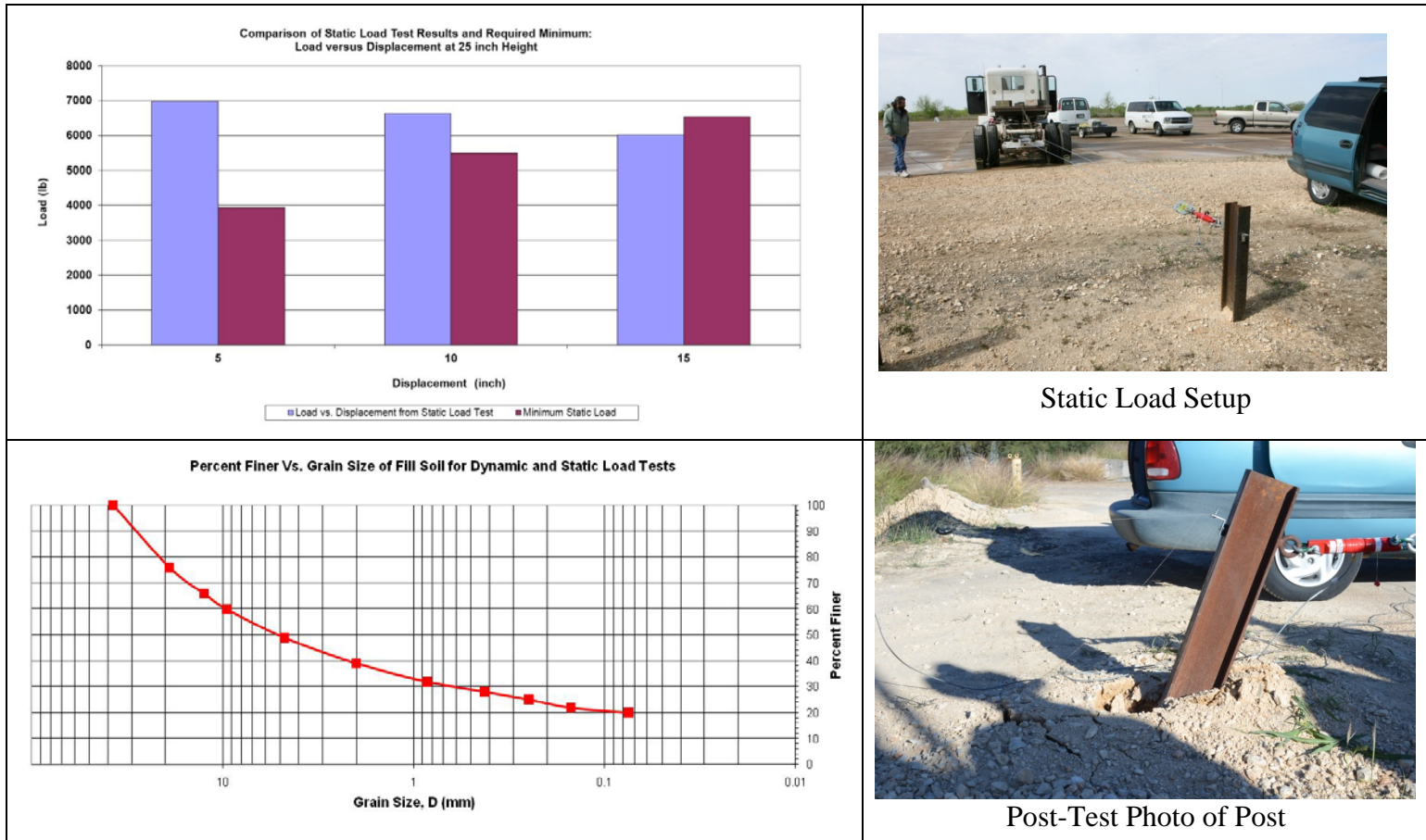

Date..... 2011-11-11

Test Facility and Site Location TTI Proving Ground – 3100 SH 47, Bryan, Tx

In Situ Soil Description (ASTM D2487) Sandy gravel with silty fines

Fill Material Description (ASTM D2487) and sieve analysis..... AASHTO Grade B Soil-Aggregate (see sieve analysis)

Description of Fill Placement Procedure 6-inch lifts tamped with a pneumatic compactor

Figure C1. Test day static soil strength documentation.

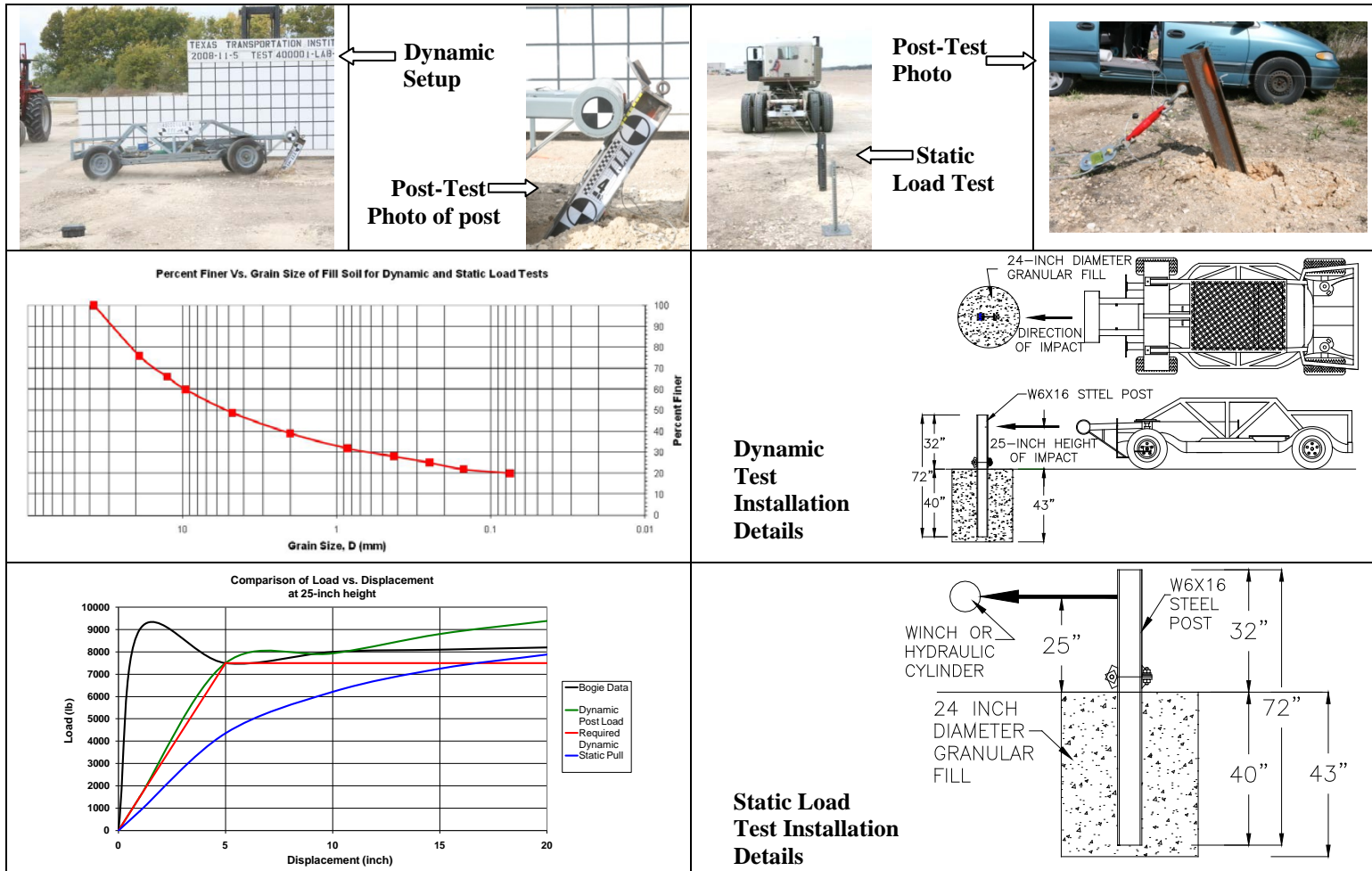

Date	2008-11-05
Test Facility and Site Location	TTI Proving Ground, 3100 SH 47, Bryan, TX 77807
In Situ Soil Description (ASTM D2487)	Sandy gravel with silty fines
Fill Material Description (ASTM D2487) and sieve analysis	AASHTO Grade B Soil-Aggregate (see sieve analysis above)
Description of Fill Placement Procedure	6-inch lifts tamped with a pneumatic compactor
Bogie Weight	5009 lb
Impact Velocity	20.5 mph

Figure C2. Summary of strong soil test results for establishing installation procedure.

APPENDIX D. CRASH TEST NO. 405160-23-2

D1. VEHICLE PROPERTIES AND INFORMATION

Table D1. Vehicle properties for test 405160-23-2.

Date: 2011-11-11 Test No.: 405160-23-2 VIN No.: 1D7HA18N03J622494

Year: 2003 Make: Dodge Model: Ram 1500

Tire Size: 245/70R17 Tire Inflation Pressure: 35 psi

Tread Type: Highway Odometer: 178099

Note any damage to the vehicle prior to test: _____

• Denotes accelerometer location.

NOTES: _____

Engine Type: V-8
Engine CID: 4.7 liter

Transmission Type:
 Auto or _____ Manual
 FWD RWD 4WD

Optional Equipment:

Dummy Data:
Type: No dummy
Mass: _____
Seat Position: _____

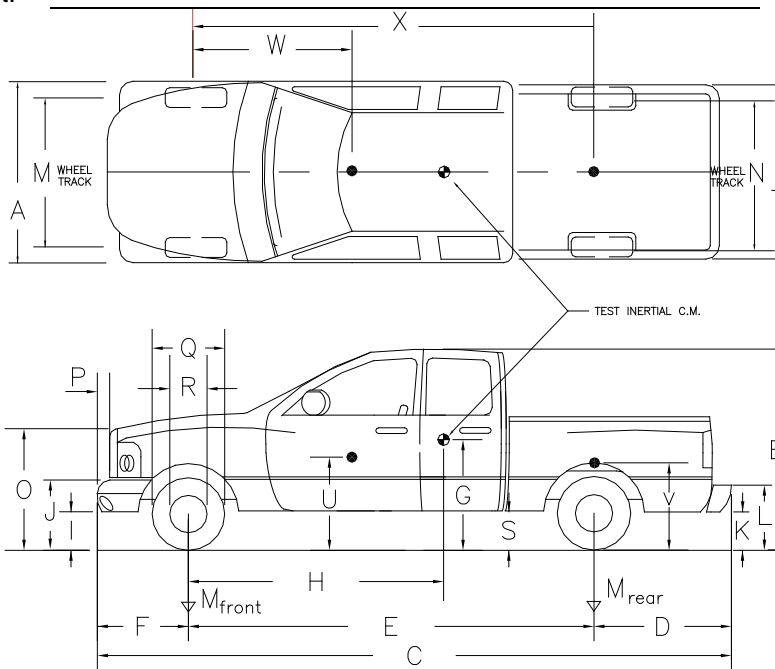

Geometry: inches

A	<u>77.00</u>	F	<u>39.00</u>	K	<u>20.30</u>	P	<u>3.00</u>	U	<u>27.50</u>
B	<u>73.25</u>	G	<u>28.00</u>	L	<u>28.75</u>	Q	<u>29.50</u>	V	<u>30.00</u>
C	<u>227.00</u>	H	<u>62.04</u>	M	<u>68.25</u>	R	<u>18.50</u>	W	<u>63.00</u>
D	<u>47.50</u>	I	<u>13.50</u>	N	<u>67.25</u>	S	<u>14.25</u>	X	<u>99.00</u>
E	<u>140.50</u>	J	<u>26.00</u>	O	<u>44.75</u>	T	<u>75.50</u>		
Wheel Center Height Front		<u>14.125</u>	Wheel Well Clearance (Front)		<u>6.125</u>	Bottom Frame Height - Front		<u>16.625</u>	
Wheel Center Height Rear		<u>14.25</u>	Wheel Well Clearance (Rear)		<u>11.25</u>	Bottom Frame Height - Rear		<u>24.25</u>	

RANGE LIMIT: A=78 ±2 inches; C=237 ±13 inches; E=148 ±12 inches; F=39 ±3 inches; G = > 28 inches; H = 63 ±4 inches; O=43 ±4 inches; M+N/2=67 ±1.5 inches

GVWR Ratings:	Mass: lb	<u>Curb</u>	<u>Test Inertial</u>	<u>Gross Static</u>
Front	<u>3650</u>	M_{front}	<u>2817</u>	<u>2795</u>
Back	<u>3900</u>	M_{rear}	<u>2083</u>	<u>2210</u>
Total	<u>6650</u>	M_{Total}	<u>4900</u>	<u>5005</u>

(Allowable Range for TIM and GSM = 5000 lb ±110 lb)

Mass Distribution:

lb LF: 1415 RF: 1380 LR: 1110 RR: 1100

Table D2. Measurements of vehicle vertical CG for test 405160-23-2.

Date: 2011-11-11 Test No.: 405160-23-2 VIN: 1D7HA18N03J622494
 Year: 2003 Make: Dodge Model: Ram 1500
 Body Style: Quad Cab Mileage: 178099
 Engine: 4.7 liter Transmission: Automatic
 Fuel Level: Empty Ballast: 241 lb at front of bed (440 lb max)
 Tire Pressure: Front: 35 psi Rear: 35 psi Size: 245/70R17

Measured Vehicle Weights: (lb)			
LF:	<u>1390</u>	RF:	<u>1390</u>
		Front Axle:	<u>2780</u>
LR:	<u>1072</u>	RR:	<u>1059</u>
		Rear Axle:	<u>2131</u>
Left:	<u>2462</u>	Right:	<u>2449</u>
		Total:	<u>4911</u>
5000 ±110 lb allow ed			
Wheel Base:	<u>140.5</u> inches	Track: F:	<u>68.25</u> inches
	148 ±12 inches allow ed	R:	<u>67.75</u> inches
		Track = (F+R)/2 = 67 ±1.5 inches allow ed	
Center of Gravity, SAE J874 Suspension Method			
X:	<u>60.97</u> in	Rear of Front Axle	(63 ±4 inches allow ed)
Y:	<u>-0.09</u> in	Left - Right +	of Vehicle Centerline
Z:	<u>28</u> in	Above Ground	(minumum 28.0 inches allow ed)

Hood Height: 44.75 inches Front Bumper Height: 26.00 inches
 43 ±4 inches allowed

Front Overhang: 39.00 inches Rear Bumper Height: 28.75 inches
 39 ±3 inches allowed

Overall Length: 227.00 inches
 237 ±13 inches allowed

Table D3. Exterior crush measurements for test 405160-23-2.

Date: 2011-11-11 Test No.: 405160-23-2 VIN No.: 1D7HA18N03J622494

Year: 2003 Make: Dodge Model: Ram 1500

VEHICLE CRUSH MEASUREMENT SHEET¹

Complete When Applicable	
End Damage	Side Damage
Undeformed end width _____	Bowing: B1 _____ X1 _____
Corner shift: A1 _____	B2 _____ X2 _____
A2 _____	
End shift at frame (CDC)	Bowing constant
(check one)	$\frac{X1 + X2}{2} = \underline{\hspace{2cm}}$
< 4 inches _____	
≥ 4 inches _____	

Note: Measure C₁ to C₆ from Driver to Passenger side in Front or Rear impacts – Rear to Front in Side Impacts.

Specific Impact Number	Plane* of C-Measurements	Direct Damage		Field L**	C ₁	C ₂	C ₃	C ₄	C ₅	C ₆	±D
		Width** (CDC)	Max*** Crush								
1	Front plane at bumper ht	15	12	36	0	2	3	6	10	12	+18
2	Side plane at bumper ht	15	14	54	0	2	---	---	12	14	+74
	Measurements recorded										
	in inches										

¹Table taken from National Accident Sampling System (NASS).

*Identify the plane at which the C-measurements are taken (e.g., at bumper, above bumper, at sill, above sill, at beltline, etc.) or label adjustments (e.g., free space).

Free space value is defined as the distance between the baseline and the original body contour taken at the individual C locations. This may include the following: bumper lead, bumper taper, side protrusion, side taper, etc. Record the value for each C-measurement and maximum crush.

**Measure and document on the vehicle diagram the beginning or end of the direct damage width and field L (e.g., side damage with respect to undamaged axle).

***Measure and document on the vehicle diagram the location of the maximum crush.

Note: Use as many lines/columns as necessary to describe each damage profile.

Table D4. Occupant compartment measurements for test 405160-23-2.

Date: 2011-11-11 Test No.: 405160-23-2 VIN No.: 1D7HA18N03J622494

Year: 2003 Make: Dodge Model: Ram 1500

OCCUPANT COMPARTMENT DEFORMATION MEASUREMENT

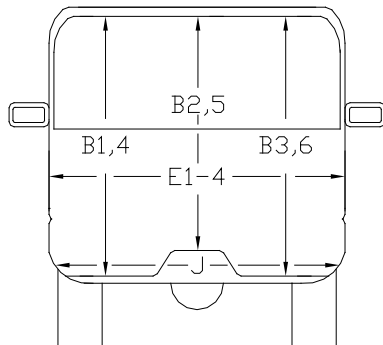
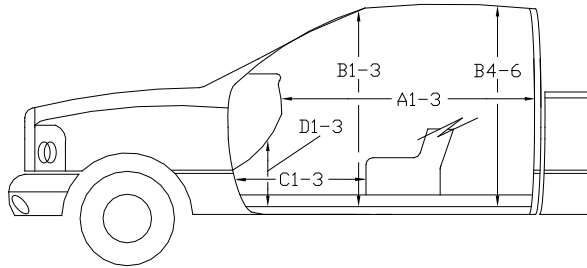
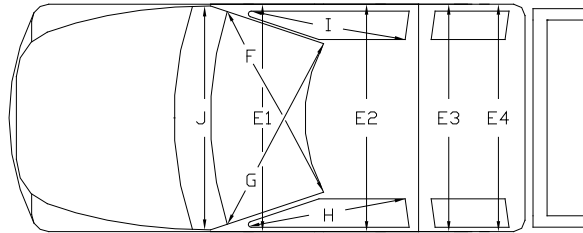

	Before (inches)	After (inches)
A1	64.50	64.50
A2	64.50	64.50
A3	65.25	65.25
B1	45.25	45.25
B2	39.12	39.12
B3	45.25	45.25
B4	42.12	42.12
B5	42.50	42.50
B6	42.12	42.12
C1	29.25	29.25
C2	----	----
C3	27.50	27.50
D1	12.75	12.75
D2	2.50	2.50
D3	11.50	11.50
E1	62.50	62.50
E2	64.50	65.00
E3	64.00	64.50
E4	64.25	64.25
F	60.00	60.00
G	60.00	60.00
H	39.50	39.50
I	39.50	39.50
J*	62.00	62.00

*Lateral area across the cab from driver's side kickpanel to passenger's side kickpanel.

D2. SEQUENTIAL PHOTOGRAPHS



0.000 s



0.092 s



0.184 s



0.270 s



Figure D1. Sequential photographs for test 405160-23-2 (overhead and frontal views).



0.368 s



0.460 s



0.552 s



0.644 s



Figure D1. Sequential photographs for test 405160-23-2 (overhead and frontal views) (continued).

Roll, Pitch, and Yaw Angles

D3. VEHICLE ANGULAR DISPLACEMENTS

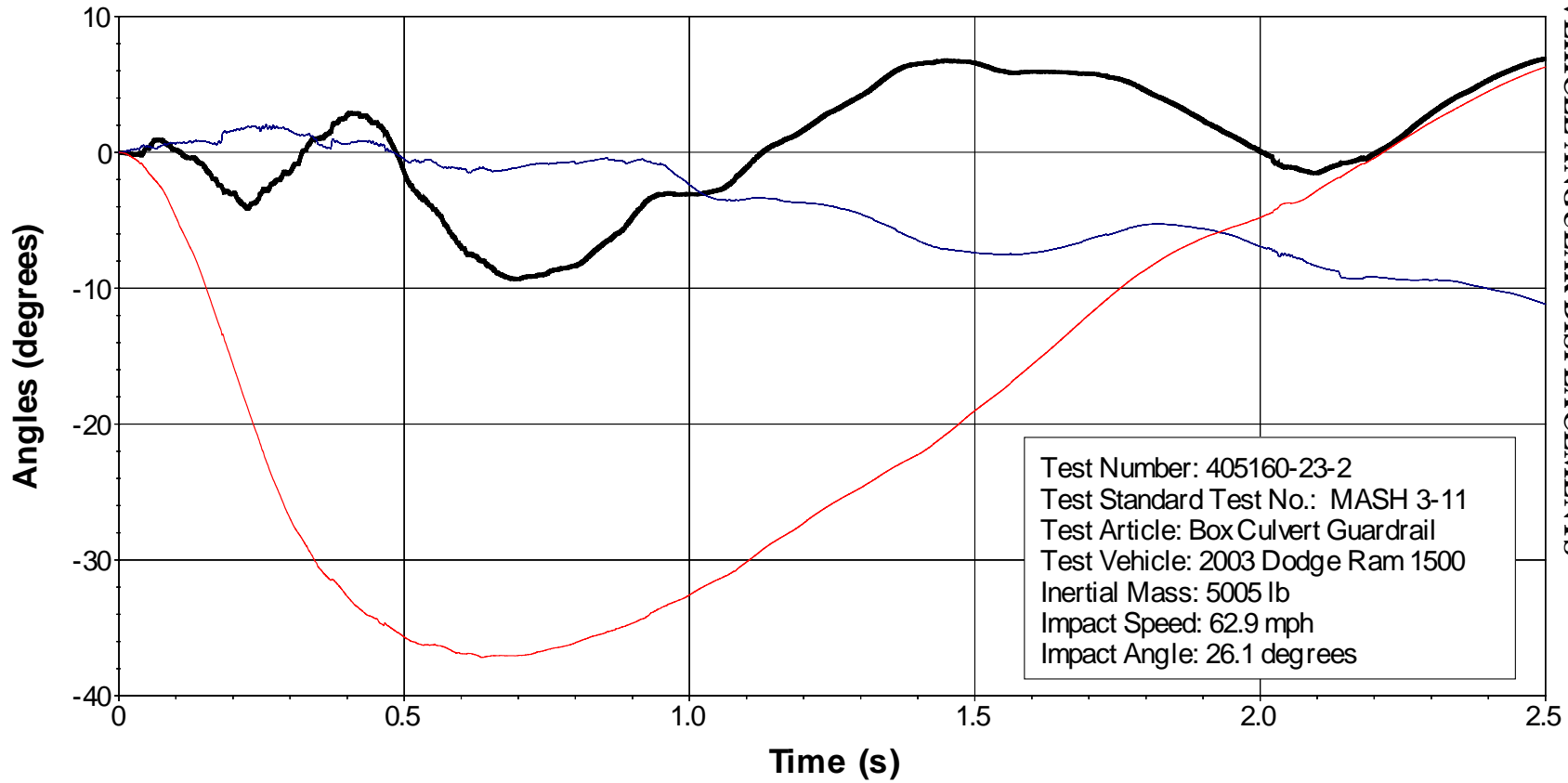

Test Number: 405160-23-2
 Test Standard Test No.: MASH 3-11
 Test Article: Box Culvert Guardrail
 Test Vehicle: 2003 Dodge Ram 1500
 Inertial Mass: 5005 lb
 Impact Speed: 62.9 mph
 Impact Angle: 26.1 degrees

— Roll — Pitch — Yaw

Axes are vehicle-fixed.
 Sequence for determining orientation:

1. Yaw.
2. Pitch.
3. Roll.

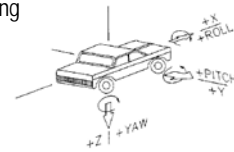

Figure D2. Vehicle angular displacements for test 405160-23-2.

X Acceleration at CG

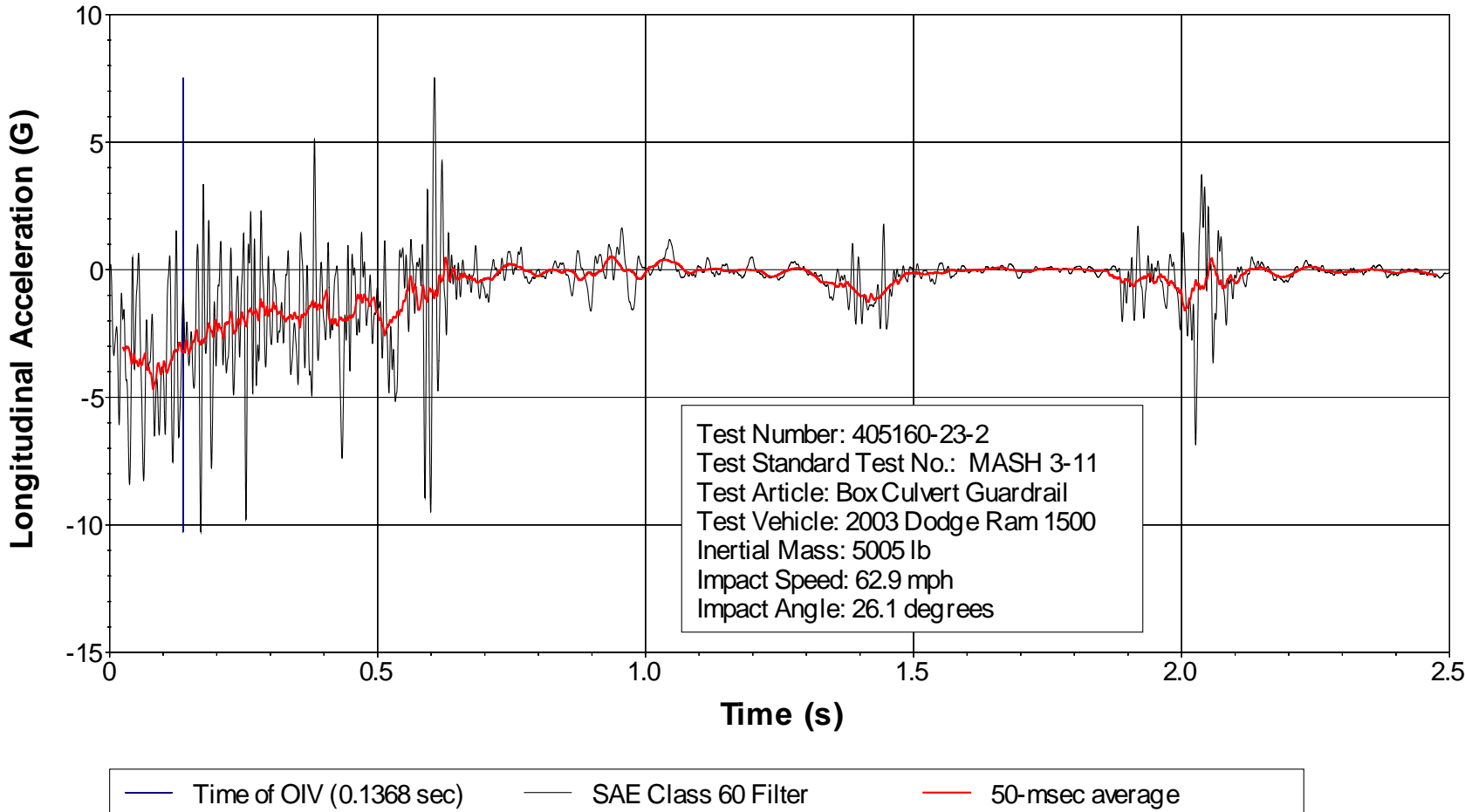

Figure D3. Vehicle longitudinal accelerometer trace for test 405160-23-2 (accelerometer located at center of gravity).

Y Acceleration at CG

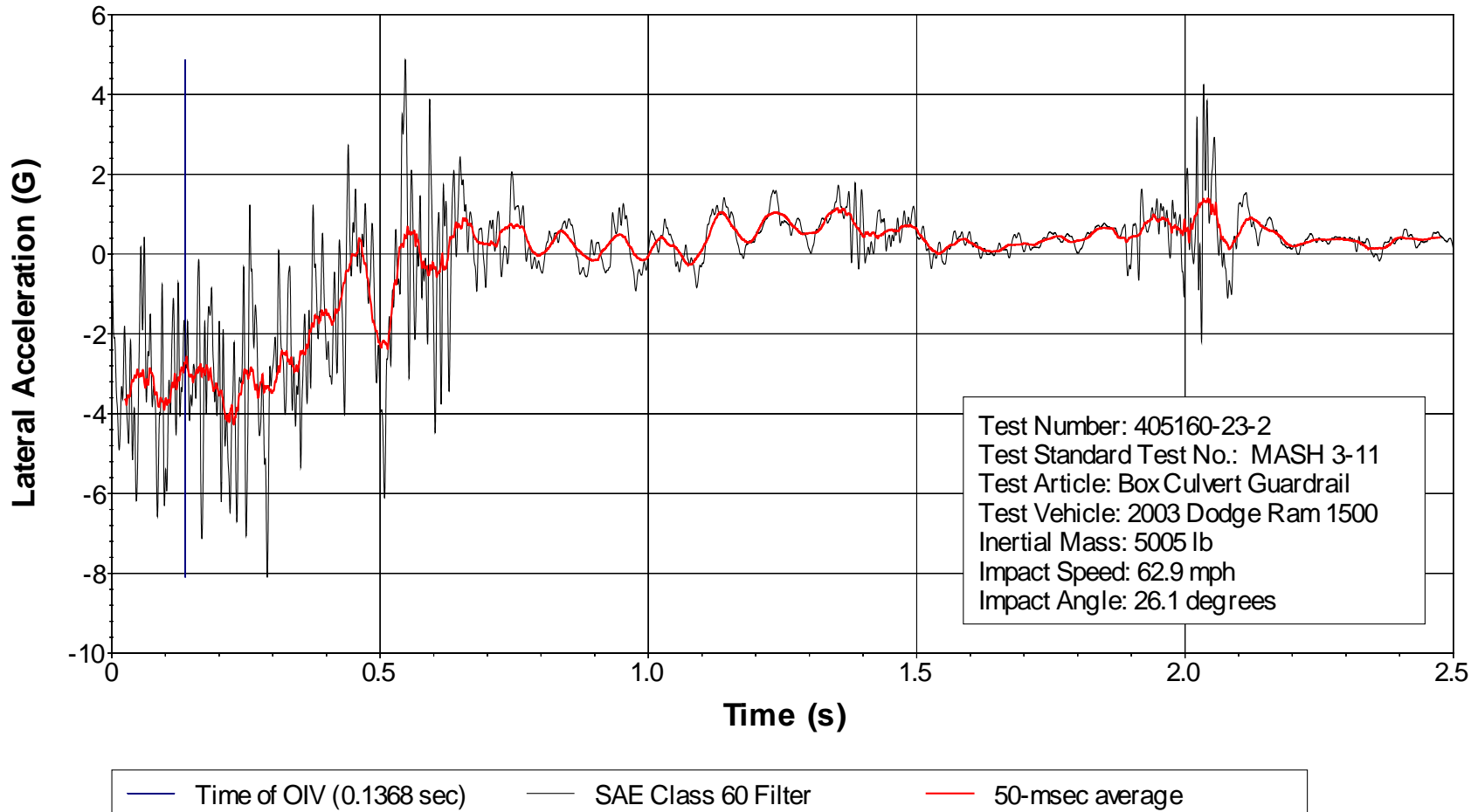

Figure D4. Vehicle lateral accelerometer trace for test 405160-23-2 (accelerometer located at center of gravity).

Z Acceleration at CG

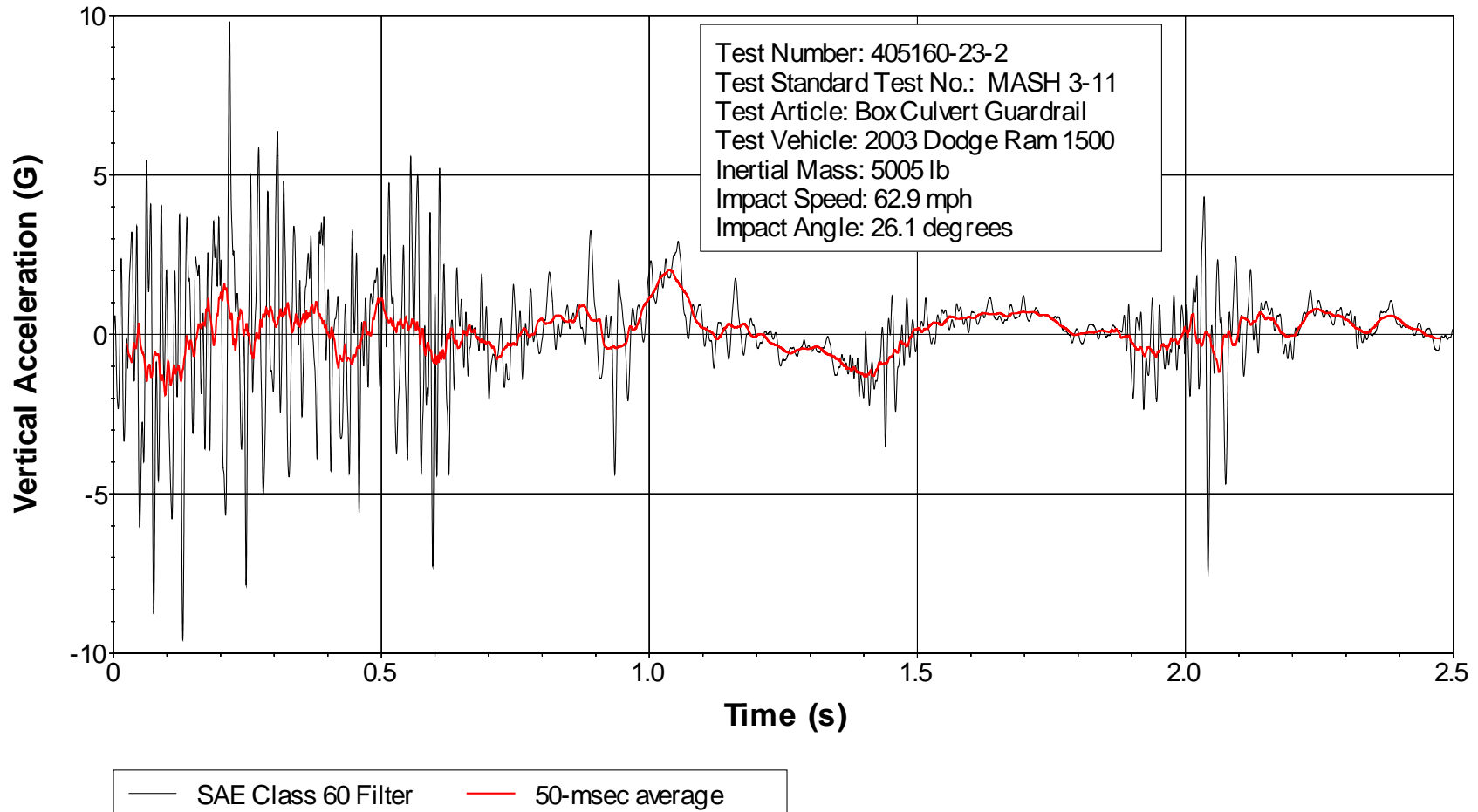
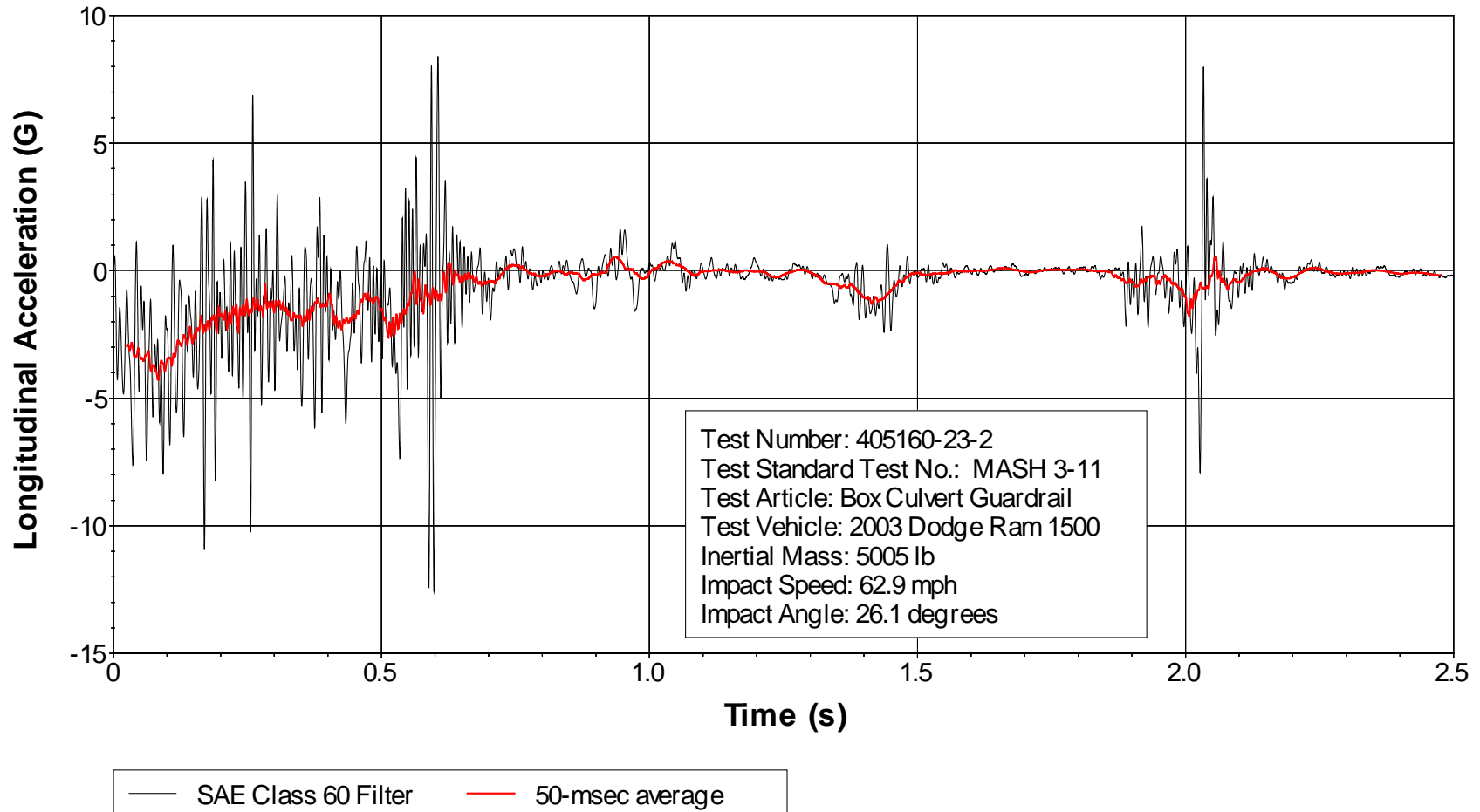

Figure D5. Vehicle vertical accelerometer trace for test 405160-23-2 (accelerometer located at center of gravity).

X Acceleration at Rear of Cab



45

Figure D6. Vehicle longitudinal accelerometer trace for test 405160-23-2 (accelerometer located over rear axle).

Y Acceleration at Rear of Cab

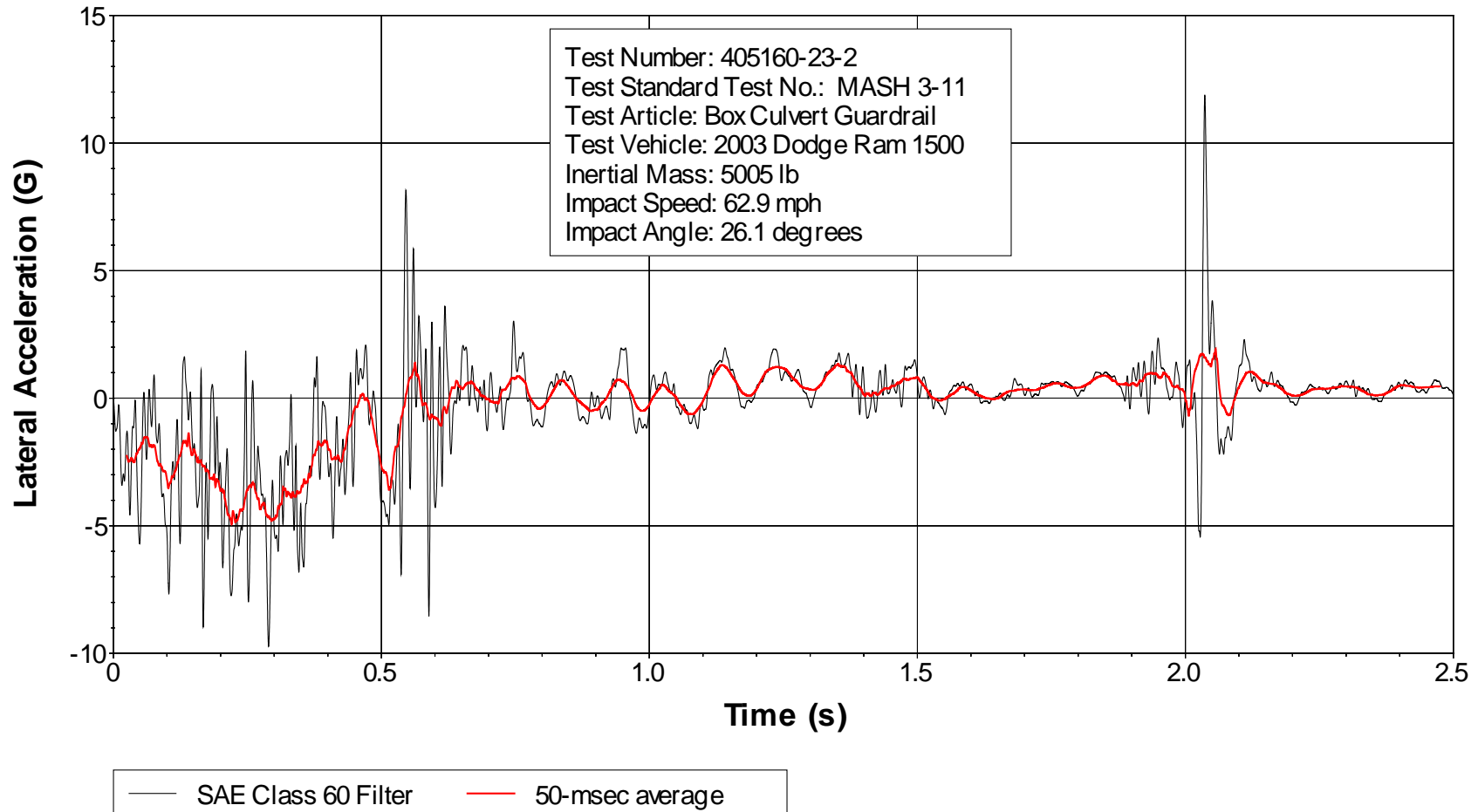

Figure D7. Vehicle lateral accelerometer trace for test 405160-23-2 (accelerometer located over rear axle).

Z Acceleration at Rear of Cab

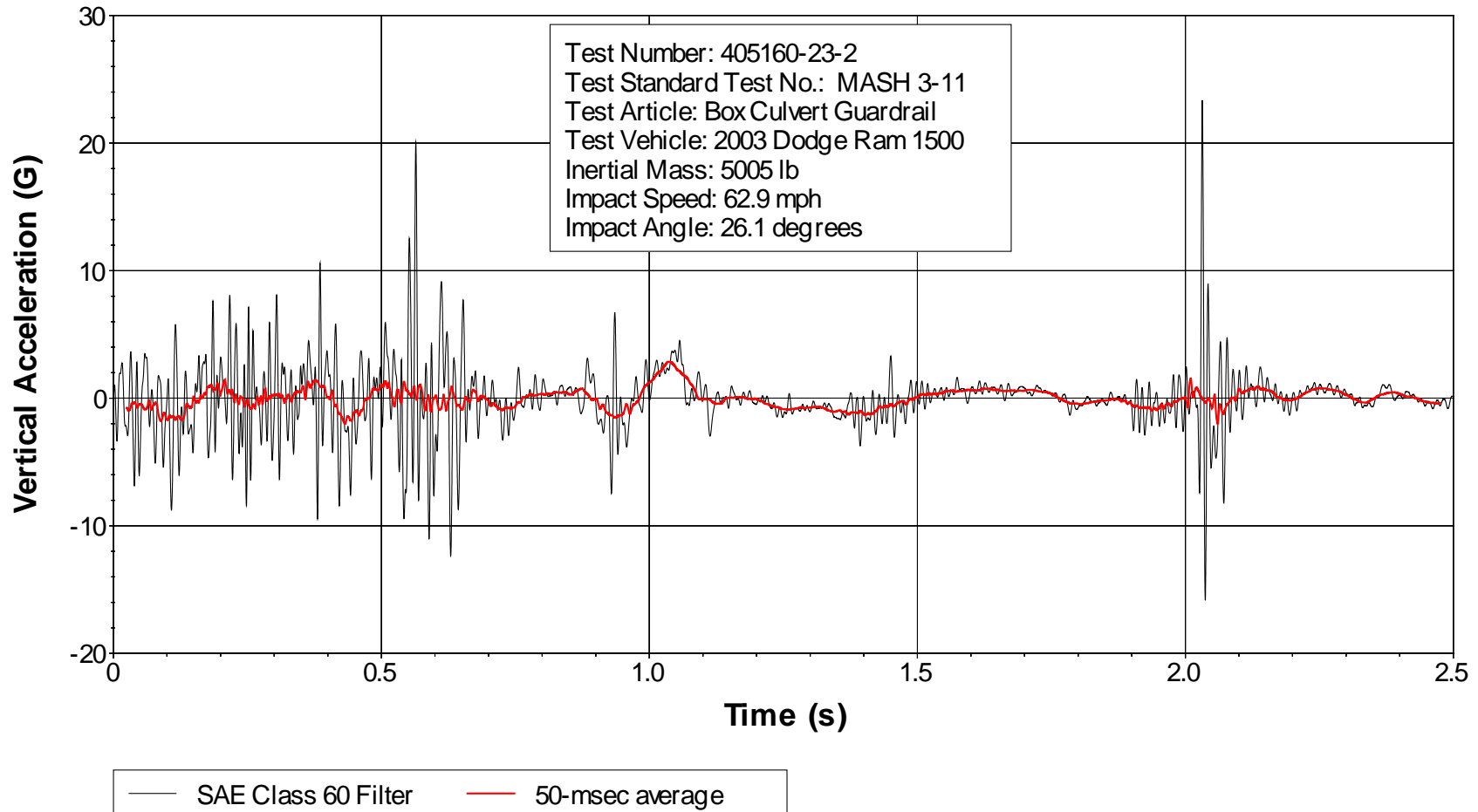

Figure D8. Vehicle vertical accelerometer trace for test 405160-23-2 (accelerometer located over rear axle).