



---

## ***MASH TEST 3-21 ON TL-3 THRIE BEAM TRANSITION WITHOUT CURB***



Crash testing performed at:  
TTI Proving Ground  
3100 SH 47, Building 7091  
Bryan, TX 77807

**Test Report 9-1002-12-3**

**Cooperative Research Program**

---

**TEXAS A&M TRANSPORTATION INSTITUTE  
COLLEGE STATION, TEXAS**

in cooperation with the  
Federal Highway Administration and the  
Texas Department of Transportation

<http://tti.tamu.edu/documents/9-1002-12-3.pdf>



1. Report No. FHWA/TX-13/9-1002-12-3		2. Government Accession No.		3. Recipient's Catalog No.	
4. Title and Subtitle <b>MASH TEST 3-21 ON TL-3 THRIE BEAM TRANSITION WITHOUT CURB</b>				5. Report Date January 2013 Published: July 2013	
				6. Performing Organization Code	
7. Author(s) Dusty R. Arrington, Roger P. Bligh, and Wanda L. Menges				8. Performing Organization Report No. Test Report 9-1002-12-3	
9. Performing Organization Name and Address Texas A&M Transportation Institute Proving Ground College Station, Texas 77843-3135				10. Work Unit No. (TRAIS)	
				11. Contract or Grant No. Project 9-1002-12	
12. Sponsoring Agency Name and Address Texas Department of Transportation Research and Technology Implementation Office P.O. Box 5080 Austin, Texas 78763-5080				13. Type of Report and Period Covered Test Report: September 2011–August 2012	
				14. Sponsoring Agency Code	
15. Supplementary Notes Project performed in cooperation with the Texas Department of Transportation and the Federal Highway Administration. Project Title: Roadside Safety Device Crash Testing Program URL: <a href="http://tti.tamu.edu/documents/9-1002-12-3.pdf">http://tti.tamu.edu/documents/9-1002-12-3.pdf</a>					
16. Abstract <p>This project evaluated the impact performance of a modified TxDOT thrie beam transition to rigid concrete barrier without a curb element below the transition rail. In a previous test described in TxDOT Research Report 0-4564, a thrie beam transition without curb failed to meet <i>NCHRP Report 350</i> performance criteria. However, it could not be discerned whether the vehicle instability observed in that test was attributable to the missing curb or the rotation of the thrie beam transition rail into the sloped face of the concrete safety shape rail at the bridge end connection point.</p> <p>A transition design without curb would reduce the complexity of the field installations and would provide an option for dealing with different drainage requirements at bridge ends. A fabricated steel blockout was incorporated into the transition system to keep the thrie beam rail and terminal connector in a vertical plane at its connection to the concrete bridge rail.</p> <p>The modified thrie beam transition without curb failed to meet <i>MASH</i> TL-3 requirements due to rollover of the impacting vehicle. Further discussions as to the possible cause of the failure are described within the report.</p>					
17. Key Words Guardrails, Terminals, End Treatments, W-Beam, Thrie Beam, Longitudinal Barriers, Crash Testing, Roadside Safety			18. Distribution Statement No restrictions. This document is available to the public through NTIS: National Technical Information Service Alexandria, Virginia 22312 <a href="http://www.ntis.gov">http://www.ntis.gov</a>		
19. Security Classif.(of this report) Unclassified		20. Security Classif.(of this page) Unclassified		21. No. of Pages 76	22. Price



***MASH* TEST 3-21 ON TL-3 THRIE BEAM TRANSITION  
WITHOUT CURB**

by

Dusty R. Arrington  
Engineering Research Associate  
Texas A&M Transportation Institute

Roger P. Bligh, P.E.  
Research Engineer  
Texas A&M Transportation Institute

and

Wanda L. Menges  
Research Specialist  
Texas A&M Transportation Institute

Test Report No. 9-1002-12-3  
Project 9-1002-12  
Project Title: Roadside Safety Device Crash Testing Program

Performed in cooperation with the  
Texas Department of Transportation  
and the  
Federal Highway Administration

January 2013  
Published: July 2013

TEXAS A&M TRANSPORTATION INSTITUTE  
College Station, Texas 77843-3135



## DISCLAIMER

This research was performed in cooperation with the Texas Department of Transportation (TxDOT) and the Federal Highway Administration (FHWA). The contents of this report reflect the views of the authors, who are responsible for the facts and the accuracy of the data presented herein. The contents do not necessarily reflect the official view or policies of the FHWA or TxDOT. This report does not constitute a standard, specification, or regulation, and its contents are not intended for construction, bidding, or permit purposes. In addition, the above listed agencies assume no liability for its contents or use thereof. The United States Government and the State of Texas do not endorse products or manufacturers. Trade or manufacturers' names appear herein solely because they are considered essential to the object of this report. The engineer in charge of the project was Roger P. Bligh, P.E. (Texas, #78550).

## TTI PROVING GROUND DISCLAIMER

The results of the crash testing reported herein apply only to the article being tested.

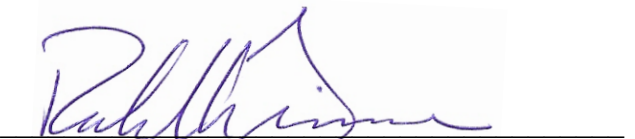

  
Wanda L. Menges, Research Specialist  
Deputy Quality Manager

  
Richard A. Zimmer, Senior Research Specialist  
Test Facility Manager  
Quality Manager  
Technical Manager

## **ACKNOWLEDGMENTS**

This research project was conducted under a cooperative program between the Texas A&M Transportation Institute, the Texas Department of Transportation, and the Federal Highway Administration. The TxDOT project director for this research was Rory Meza (DES). John Holt (BRG) and Wade Odell (RTI) also contributed significantly to the project. The authors acknowledge and appreciate their guidance and assistance.



# TABLE OF CONTENTS

	Page
LIST OF FIGURES .....	viii
LIST OF TABLES .....	ix
CHAPTER 1. INTRODUCTION .....	1
1.1 INTRODUCTION .....	1
1.2 BACKGROUND .....	1
1.3 OBJECTIVES/SCOPE OF RESEARCH .....	2
CHAPTER 2. SYSTEM DETAILS .....	3
2.1 TEST ARTICLE DESIGN AND CONSTRUCTION .....	3
2.2 MATERIAL SPECIFICATIONS .....	7
2.3 SOIL CONDITIONS .....	7
CHAPTER 3. TEST REQUIREMENTS AND EVALUATION CRITERIA .....	9
3.1 CRASH TEST MATRIX .....	9
3.2 EVALUATION CRITERIA .....	9
CHAPTER 4. CRASH TEST PROCEDURES .....	11
4.1 TEST FACILITY .....	11
4.2 VEHICLE TOW AND GUIDANCE PROCEDURES .....	11
4.3 DATA ACQUISITION SYSTEMS .....	11
4.3.1 Vehicle Instrumentation and Data Processing .....	11
4.3.2 Anthropomorphic Dummy Instrumentation .....	12
4.3.3 Photographic Instrumentation and Data Processing .....	12
CHAPTER 5. CRASH TEST RESULTS .....	13
5.1 TEST DESIGNATION AND ACTUAL IMPACT CONDITIONS .....	13
5.2 TEST VEHICLE .....	13
5.3 WEATHER CONDITIONS .....	13
5.4 TEST DESCRIPTION .....	13
5.5 DAMAGE TO TEST INSTALLATION .....	15
5.6 VEHICLE DAMAGE .....	15
5.7 OCCUPANT RISK FACTORS .....	15
CHAPTER 6. SUMMARY AND CONCLUSIONS .....	21
6.1 ASSESSMENT OF TEST RESULTS .....	21
6.1.1 Structural Adequacy .....	21
6.1.2 Occupant Risk .....	21
6.1.3 Vehicle Trajectory .....	22
6.2 CONCLUSIONS .....	22
6.3 RECOMMENDATIONS .....	22
CHAPTER 7. IMPLEMENTATION STATEMENT .....	25
REFERENCES .....	27
APPENDIX A. DETAILS OF THE TXDOT TL-3 TRANSITION .....	29
APPENDIX B. CERTIFICATION DOCUMENTATION .....	39
APPENDIX C. SOIL STRENGTH DOCUMENTATION .....	49
APPENDIX D. TEST VEHICLE PROPERTIES AND INFORMATION .....	51
APPENDIX E. SEQUENTIAL PHOTOGRAPHS .....	55
APPENDIX F. VEHICLE ANGULAR DISPLACEMENTS AND ACCELERATIONS .....	59

## LIST OF FIGURES

Figure		Page
Figure 2.1.	Layout of the TxDOT TL-3 Transition.....	4
Figure 2.2.	Details of the TxDOT TL-3 Transition.....	5
Figure 2.3.	TxDOT TL-3 Transition Installation before Test No. 490022-4.....	6
Figure 5.1.	Vehicle before Test No. 490022-4.....	14
Figure 5.2.	TxDOT TL-3 Transition/Vehicle after Test No. 490022-4.....	16
Figure 5.3.	TxDOT TL-3 Transition after Test No. 490022-4.....	17
Figure 5.4.	Vehicle after Test No. 490022-4.....	18
Figure 5.5.	Interior of Vehicle after Test No. 490022-4.....	19
Figure 5.6.	Summary of Results for <i>MASH</i> Test 3-21 on the TxDOT TL-3 Transition.....	20
Figure E1.	Sequential Photographs for Test No. 490022-4 (Overhead and Frontal Views).....	55
Figure E2.	Sequential Photographs for Test No. 490022-4 (Rear View).....	57
Figure F1.	Vehicle Angular Displacements for Test No. 490022-4.....	59
Figure F2.	Vehicle Longitudinal Accelerometer Trace for Test No. 490022-4 (Accelerometer Located at Center of Gravity).....	60
Figure F3.	Vehicle Lateral Accelerometer Trace for Test No. 490022-4 (Accelerometer Located at Center of Gravity).....	61
Figure F4.	Vehicle Vertical Accelerometer Trace for Test No. 490022-4 (Accelerometer Located at Center of Gravity).....	62
Figure F5.	Vehicle Longitudinal Accelerometer Trace for Test No. 490022-4 (Accelerometer Located Rear of Center of Gravity).....	63
Figure F6.	Vehicle Lateral Accelerometer Trace for Test No. 490022-4 (Accelerometer Located Rear of Center of Gravity).....	64
Figure F7.	Vehicle Vertical Accelerometer Trace for Test No. 490022-4 (Accelerometer Located Rear of Center of Gravity).....	65

## LIST OF TABLES

Table		Page
Table 6.1.	Performance Evaluation Summary for <i>MASH</i> Test 3-21 on the TxDOT TL-3 Transition.....	23
Table C1.	Test Day Static Soil Strength Documentation for Test No. 490022-4. ....	49
Table C2.	Summary of Strong Soil Test Results for Establishing Installation Procedure. ....	50
Table D1.	Vehicle Properties for Test No. 490022-4. ....	51
Table D2.	Vehicle Parametric Measurements for Test No. 490022-4.....	52
Table D3.	Exterior Crush Measurements for Test No. 490022-4.....	53
Table D4.	Occupant Compartment Measurements for Test No. 490022-4. ....	54



# CHAPTER 1. INTRODUCTION

## 1.1 INTRODUCTION

This project was set up to provide the Texas Department of Transportation (TxDOT) with a mechanism to quickly and effectively evaluate high-priority issues related to roadside safety devices. Roadside safety devices shield motorists from roadside hazards such as non-traversable terrain and fixed objects. To maintain the desired level of safety for the motoring public, these safety devices must be designed to accommodate a variety of site conditions, placement locations, and a changing vehicle fleet. Periodically, there is a need to assess the compliance of existing safety devices with current vehicle testing criteria and develop new devices that address identified needs.

Under this project, roadside safety issues are identified and prioritized for investigation. Each roadside safety issue is addressed with a separate work plan, and the results are summarized in individual test reports.

## 1.2 BACKGROUND

Current roadside safety barriers can be generalized into a two categories. The first category includes rigid barriers such as permanent concrete median barriers. The second category includes flexible barriers such as metal beam guard fence. These barriers are highly effective in redirecting errant vehicles; however, they have significantly different deflection characteristics. Approach guardrail is often attached to a bridge rail to shield motorists from hazards at the bridge end and those underlying the bridge. A transition system is needed to transition the stiffness between the two systems to avoid impact performance issues such as pocketing and snagging on the rigid end of the bridge parapet.

In May 1998, Midwest Roadside Safety Facility (MwRSF) released a report detailing the design and testing of “Two Approach Guardrail Transitions for Concrete Safety Shape Barriers.” This research was funded by the Midwest State’s Regional Pooled Fund Program. The report details the design and testing of both steel and wood post options for transitioning W-beam guardrail to a concrete safety shape barrier. Two key features of these nested thrie beam transition designs include a curb under the transition rail near the concrete parapet end and a steel offset block that allows the thrie beam to be vertically connected to the sloped face of the concrete parapet without having to twist the thrie beam section. Both designs met National Cooperative Highway Research Program (NCHRP) *Report 350 (I)* evaluation criteria for Test Level 3 (TL-3).

In October 2003, TxDOT requested that Texas A&M Transportation Institute (TTI) evaluate a modified TL-3 nested thrie beam transition. The first modification was to eliminate the curb from under the transition rail. Second, the fabricated steel offset block under the terminal connector was removed. Instead, the nested thrie beam and terminal connector was twisted to match and connect directly to the sloped face of the concrete safety shape parapet.

TxDOT requested these modifications to reduce fabrication and installation complexity and cost. The modified transition system failed to meet *NCHRP Report 350* TL-3 performance criteria. The impacting vehicle overturned as it exited the transition system. It could not be conclusively determined which modification contributed more to the vehicle instability.

The American Association of State Highway and Transportation Officials (AASHTO) published the *Manual for Assessing Safety Hardware (MASH)* in October 2009 (2). *MASH* supersedes *NCHRP Report 350* as the recommended guidance for the safety performance evaluation of roadside safety features. In October 2006, MwRSF published Research Report TRP-03-175-06. This report documents a successful *MASH* TL-3 crash test (Test Designation 3-21) on the original nested thrie beam transition design. This test was performed as part of NCHRP Project 22-14 (2).

Subsequently, TxDOT requested that a *MASH* test be performed to evaluate the impact performance of a modified TxDOT thrie beam transition to rigid concrete barrier without a curb element below the transition rail. A transition design without curb would reduce the complexity of the field installations and would provide an option for dealing with different drainage requirements at bridge ends. The difference between the previous failed transition test and the proposed design is that a fabricated steel blockout was incorporated into the transition system to keep the thrie beam rail and terminal connector in a vertical plane at its connection to the concrete bridge rail.

### **1.3 OBJECTIVES/SCOPE OF RESEARCH**

This project evaluated the impact performance of a modified transition design for approach W-beam guardrail to a rigid concrete bridge rail without a curb element beneath the transition rail. The test was performed in accordance with *MASH* guidelines following the impact conditions for Test Designation 3-21.

## CHAPTER 2. SYSTEM DETAILS

### 2.1 TEST ARTICLE DESIGN AND CONSTRUCTION

A total installation length of 92 ft-6<sup>3</sup>/<sub>4</sub> inch was installed to fully evaluate the bridge rail to metal beam guard fence transition according to *MASH* TL-3 impact conditions. A 16-ft single slope concrete bridge rail served as a surrogate bridge rail parapet end condition. The remaining 76 ft-6<sup>3</sup>/<sub>4</sub> inches was constructed of metal beam guard fence. This length includes a TL-3 approved terminal and the TL-3 transition itself. A generic overall diagram of the test installation can be found in [Figures 2.1](#) and [2.2](#). A full set of shop/fabrication drawings can be found in [Appendix A](#).

The surrogate bridge rail parapet was constructed according to TxDOT 36-inch single slope traffic rail (SSTR) bridge rail standards found on the TxDOT standards website (<http://www.dot.state.tx.us>). As the standard suggests, the barrier is a 36-inch tall wall with a 79 degree constant slope traffic face. The barrier is 7<sup>1</sup>/<sub>2</sub> inches wide at the top of the barrier and 14<sup>1</sup>/<sub>2</sub> inches wide at the bottom of the barrier at the end of the parapet. The barrier is cast atop an 18-inch thick moment slab designed to withstand a *MASH* TL-4 impact. The concrete used in constructing the parapet and moment slab met/exceeded TxDOT Class C (3600 psi) specifications. The barrier toe was chamfered at the end of the parapet. The chamfer was 13<sup>3</sup>/<sub>8</sub> inches tall and 36 inches long. A total of five 1-inch holes were cast into the parapet to allow for the attachment of the 10 gauge thrie-beam terminal end shoe (RTE01b) and a custom 1/4-inch thick adapter plate using five 7/8-inch A325 bolts.

The reinforcement in the parapet included the following according to TxDOT SSTR barrier standards. “S-bars” and “U-bars” are placed every 5 inches along the length of the parapet. A total of eight #4 bars (1/2-inch) were equally spaced along the face of the parapet. The 18-inch deck was reinforced with two distinct rebar mats each containing #5 bars spaced every 6 inches perpendicular to the parapet and #4 bars spaced every 9 inches parallel to the parapet. The first mat maintained a 3-inch cover from the bottom of the moment slab. The second mat maintained a 2-inch cover from the top of the moment slab.

The metal beam guard fence was constructed using a total of 19 posts that were numbered from 1 to 19 starting with the ET-2000 Terminal control release post (CRP) anchor post. Posts 1 and 2 were installed as part of the standard 31-inch ET-2000 Terminal. Posts 3 through 11 are installed as part of a standard 12 gauge W-Beam Guardrail (RWM04a). Each post in this section is a 72-inch long W6×8.5 SLP (PEW01) attached to the 12 gauge rail element using an 8-inch wood blockout. The posts in this section were placed at the mid-span of the guardrail (not at a splice). Between posts 11 and 13, a 10 gauge thrie beam to W-beam non-symmetric transition segment is used and is supported by a 72-inch long W6×8.5 SLP. Between Post 13 and the end of the bridge parapet, a nested 12 gauge thrie beam (RTM02a) configuration is used and is supported by 84-inch long W6×8.5 posts with 6×8×18-inch wood blockouts. A 10 gauge thrie-beam end shoe (RTE01b) was used to connect the nested thrie beam to the 1/4-inch thick adapter plate.

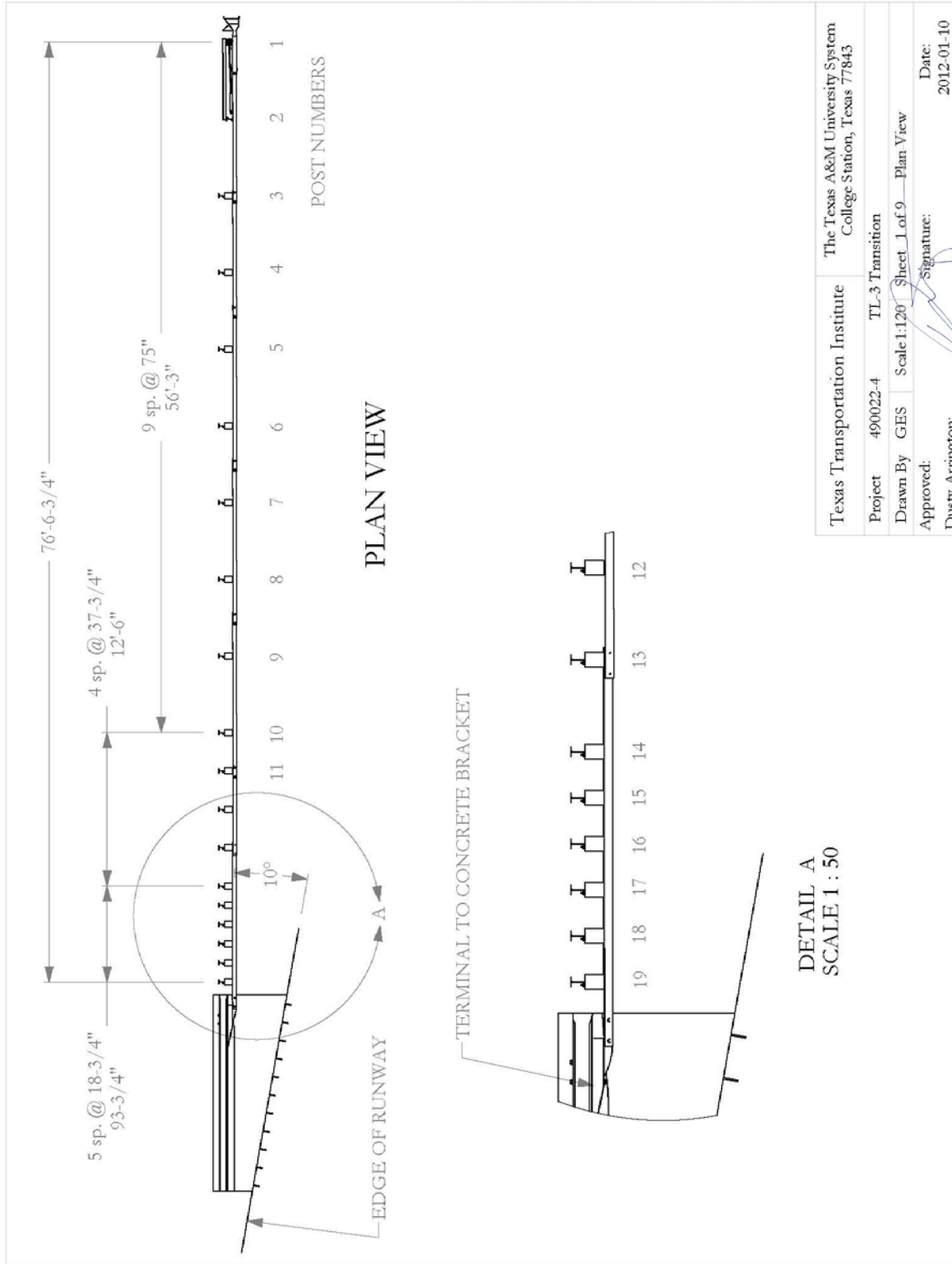

**Figure 2.1. Layout of the TxDOT TL-3 Transition.**

T:\2011-2012\490022 TxDOT\4 TL-3 Transition\Drawings\TL-3 Installation



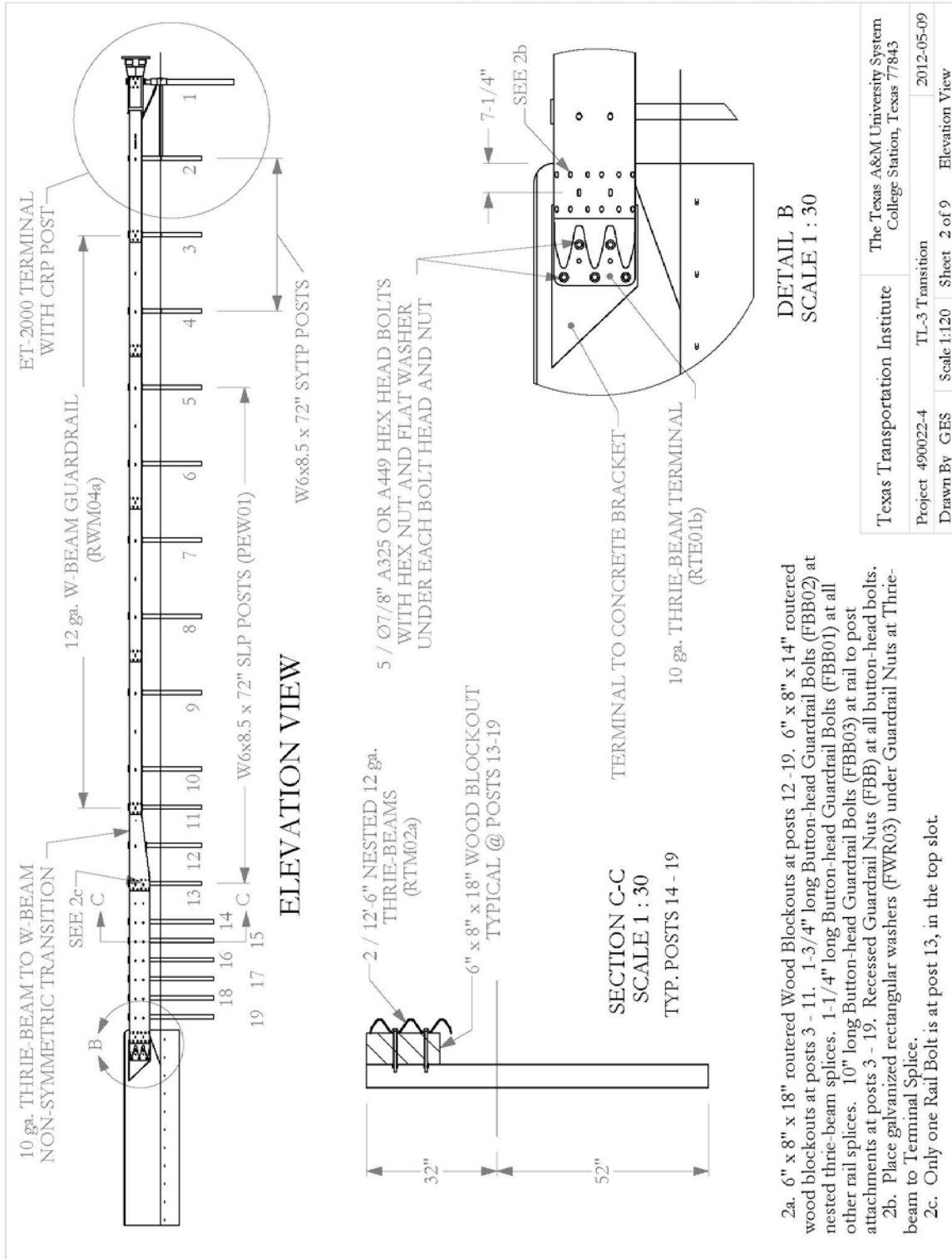

T:\2011-2012\490022 TxDOT\4 TL-3 Transition\Drafting\TL-3 Installation

Texas Transportation Institute	The Texas A&M University System College Station, Texas 77843
Project 490022-4	TL-3 Transition
Drawn By GES	Scale 1:120
Sheet 2 of 9	Elevation View
	2012-05-09

**Figure 2.2. Details of the TxDOT TL-3 Transition.**



**Figure 2.3. TxDOT TL-3 Transition Installation before Test No. 490022-4.**

The adapter plate is constructed using ¼-inch steel plate. The adapter is 21 inches tall and 40 inches wide. The adapter plate allows for a 4-inch blockout at the top of the plate and tapers down to a 0-inch blockout distance. Quarter-inch thick stiffener plates are then welded to the back of the plate to stiffen the plate.

## **2.2 MATERIAL SPECIFICATIONS**

As discussed in [section 2.1](#), the concrete used to construct the concrete parapet meets/exceeds TxDOT Class C (3600 psi) specifications. All steel plates and structural members meet A36 material specifications. All standard American Road and Transportation Builders Association (ARTBA) parts meet/exceed material specifications associated with their assigned classification numbers.

## **2.3 SOIL CONDITIONS**

The TxDOT TL-3 Transition was installed in standard soil meeting AASHTO standard specifications for “Materials for Aggregate and Soil Aggregate Subbase, Base and Surface Courses,” designated M147-65(2004), grading B.

In accordance with Appendix B of *MASH*, soil strength was measured the day of the crash test (see [Appendix C, Table C1](#)). During installation of the TxDOT TL-3 Transition for full-scale crash testing, two standard W6×16 posts were installed in the immediate vicinity of the TxDOT TL-3 Transition, utilizing the same fill materials and installation procedures used in the standard dynamic test (see [Appendix C, Table C2](#)).

As determined in the tests shown in [Appendix C, Table C2](#), the minimum post load required for deflections at 5 inches, 10 inches, and 15 inches, measured at a height of 25 inches, is 3940 lb, 5500 lb, and 6540 lb, respectively (90 percent of static load for the initial standard installation). On the day of the test, April 14, 2009, load on the post at deflections of 5 inches, 10 inches, and 15 inches was 8121 lbf, 7303 lbf, and 6909 lbf, respectively. The strength of the backfill material met minimum requirements.



## CHAPTER 3. TEST REQUIREMENTS AND EVALUATION CRITERIA

### 3.1 CRASH TEST MATRIX

According to *MASH*, two tests are recommended to evaluate transitions to test level three (TL-3).

***MASH* Test Designation 3-20:** A 2425-lb vehicle impacting the critical impact point (CIP) of the length of need (LON) of the barrier at a nominal impact speed and angle of 62 mi/h and 25 degrees, respectively. This test investigates a barrier's ability to successfully contain and redirect a small passenger vehicle.

***MASH* Test Designation 3-21:** A 5000-lb pickup truck impacting the CIP of the LON of the barrier at a nominal impact speed and angle of 62 mi/h and 25 degrees, respectively. This test investigates a barrier's ability to successfully contain and redirect light trucks and sport utility vehicles.

Based on the geometry and strength of the transition design, the project team concluded that Test 3-20 was not warranted. The test reported here corresponds to Test 3-21 of *MASH* (5000-lb pickup, 62 mi/h, 25 degrees).

The crash test and data analysis procedures were in accordance with guidelines presented in *MASH*. [Chapter 4](#) presents brief descriptions of these procedures.

### 3.2 EVALUATION CRITERIA

The crash test was evaluated in accordance with the criteria presented in *MASH*. The performance of the TxDOT TL-3 Transition is judged on the basis of three factors: structural adequacy, occupant risk, and post impact vehicle trajectory. Structural adequacy is judged upon the ability of the TxDOT TL-3 Transition to contain and redirect the vehicle, or bring the vehicle to a controlled stop in a predictable manner. Occupant risk criteria evaluate the potential risk of hazard to occupants in the impacting vehicle, and to some extent, other traffic, pedestrians, or workers in construction zones, if applicable. Post-impact vehicle trajectory is assessed to determine potential for secondary impact with other vehicles or fixed objects, creating further risk of injury to occupants of the impacting vehicle and/or risk of injury to occupants in other vehicles. The appropriate safety evaluation criteria from Table 5-1 of *MASH* were used to evaluate the crash test reported here and are listed in further detail under the assessment of the crash test.



## **CHAPTER 4. CRASH TEST PROCEDURES**

### **4.1 TEST FACILITY**

The full-scale crash test reported here was performed at Texas A&M Transportation Institute Proving Ground, an International Standards Organization (ISO) 17025 accredited laboratory with American Association for Laboratory Accreditation (A2LA) Mechanical Testing certificate 2821.01. The full-scale crash test was performed according to TTI Proving Ground quality procedures and according to the *MASH* guidelines and standards.

The Texas A&M Transportation Institute Proving Ground is a 2000-acre complex of research and training facilities located 10 miles northwest of the main campus of Texas A&M University. The site, formerly an Air Force base, has large expanses of concrete runways and parking aprons well-suited for experimental research and testing in the areas of vehicle performance and handling, vehicle-roadway interaction, durability and efficacy of highway pavements, and safety evaluation of roadside safety hardware. The site selected for construction and testing of the T131RC Bridge Rail evaluated under this project was along the edge of an out-of-service apron. The apron consists of an unreinforced jointed-concrete pavement in 12.5 ft × 15 ft blocks nominally 6 inches deep. The apron is over 60 years old, and the joints have some displacement, but are otherwise flat and level.

### **4.2 VEHICLE TOW AND GUIDANCE PROCEDURES**

The test vehicle was towed into the test installation using a steel cable guidance and reverse tow system. A steel cable for guiding the test vehicle was tensioned along the path, anchored at each end, and threaded through an attachment to the front wheel of the test vehicle. An additional steel cable was connected to the test vehicle, passed around a pulley near the impact point, through a pulley on the tow vehicle, and then anchored to the ground such that the tow vehicle moved away from the test site. A 2:1 speed ratio between the test and tow vehicle existed with this system. Just prior to impact with the installation, the test vehicle was released to be unrestrained. The vehicle remained free-wheeling (i.e., no steering or braking inputs) until it cleared the immediate area of the test site, after which the brakes were activated to bring it to a safe and controlled stop.

### **4.3 DATA ACQUISITION SYSTEMS**

#### **4.3.1 Vehicle Instrumentation and Data Processing**

The test vehicle was instrumented with a self-contained, on-board data acquisition system. The signal conditioning and acquisition system is a 16-channel, Tiny Data Acquisition System (TDAS) Pro produced by Diversified Technical Systems, Inc. The accelerometers that measure the x, y, and z axis of vehicle acceleration are strain gauge type with linear millivolt output proportional to acceleration. Angular rate sensors measuring vehicle roll, pitch, and yaw

rates are ultra-small size, solid state units designed for crash test service. The TDAS Pro hardware and software conform to the latest SAE J211, Instrumentation for Impact Test. Each of the 16 channels is capable of providing precision amplification, scaling, and filtering based on transducer specifications and calibrations. During the test, data are recorded from each channel at a rate of 10,000 values per second with a resolution of one part in 65,536. Once the data are recorded, internal batteries back these up inside the unit should the primary battery cable be severed. Initial contact of the pressure switch on the vehicle bumper provides a time zero mark and initiates the recording process. After each test, the data are downloaded from the TDAS Pro unit into a laptop computer at the test site. The Test Risk Assessment Program (TRAP) software then processes the raw data to produce detailed reports of the test results. Each of the TDAS Pro units are returned to the factory annually for complete recalibration. Accelerometers and rate transducers are also calibrated annually with traceability to the National Institute for Standards and Technology.

TRAP uses the data from the TDAS Pro to compute occupant/compartment impact velocities, time of occupant/compartment impact after vehicle impact, and the highest 10-millisecond (ms) average ridedown acceleration. TRAP calculates change in vehicle velocity at the end of a given impulse period. In addition, the program computes the maximum average accelerations over 50-ms intervals in each of the three directions. For reporting purposes, the data from the vehicle-mounted accelerometers are filtered with a 60-Hz digital filter, and acceleration versus time curves for the longitudinal, lateral, and vertical directions are plotted using TRAP.

TRAP uses the data from the yaw, pitch, and roll rate transducers to compute angular displacement in degrees at 0.0001-s intervals and then plots yaw, pitch, and roll versus time. These displacements are in reference to the vehicle-fixed coordinate system with the initial position and orientation of the vehicle-fixed coordinate systems being initial impact.

#### **4.3.2 Anthropomorphic Dummy Instrumentation**

According to *MASH*, the use of a dummy in the 2270P vehicle is optional. Researchers did not use any dummy in the test with the 2270P vehicle.

#### **4.3.3 Photographic Instrumentation and Data Processing**

Photographic coverage of the test included three high-speed cameras: one overhead with a field of view perpendicular to the ground and directly over the impact point; one placed behind the installation at an angle; and a third placed to have a field of view parallel to and aligned with the installation at the downstream end. A flashbulb activated by pressure-sensitive tape switches was positioned on the impacting vehicle to indicate the instant of contact with the installation and was visible from each camera. The films from these high-speed cameras were analyzed on a computer-linked motion analyzer to observe phenomena occurring during the collision and to obtain time-event, displacement, and angular data. A mini-DV camera and still cameras recorded and documented conditions of the test vehicle and installation before and after the test.



## CHAPTER 5. CRASH TEST RESULTS

### 5.1 TEST DESIGNATION AND ACTUAL IMPACT CONDITIONS

*MASH* Test 3-21 involves a 2270P vehicle weighing 5000 lb  $\pm$ 100 lb and impacting the bridge rail transition at an impact speed of 62.2 mi/h  $\pm$ 2.5 mi/h and an angle of 25 degrees  $\pm$ 1.5 degrees. The target impact point of 93 inches upstream of concrete parapet was determined through Barrier VII simulations and the tables found within *MASH* for determining CIP. The 2006 Dodge Ram 1500 pickup truck used in the test weighed 5002 lb and the actual impact speed and angle were 62.6 mi/h and 23.9 degrees, respectively. The actual impact point was 89.0 inches upstream of the concrete parapet. Target impact severity (IS) was calculated at 115.1 kip\*ft, and actual IS was calculated at 107.6 kip\*ft, which was 6.5 percent less than target IS (acceptable limit for IS is not less than 8 percent of target IS).

### 5.2 TEST VEHICLE

A 2006 Dodge Ram 1500 pickup truck, shown in [Figure 5.1](#), was used for the crash test. Test inertia weight of the vehicle was 5002 lb, and its gross static weight was 5002 lb. The height to the lower edge of the vehicle bumper was 13.7 inches, and it was 25.38 inches to the upper edge of the bumper. [Tables D1](#) and [D2](#) in [Appendix D](#) give additional dimensions and information on the vehicle. The vehicle was directed into the installation using the cable reverse tow and guidance system, and was released to be unrestrained just prior to impact.

### 5.3 WEATHER CONDITIONS

The test was performed on the morning of May 14, 2012. Weather conditions at the time of testing were: wind speed: 2 mi/h; wind direction: 206 degrees with respect to the vehicle (vehicle was traveling in a southwesterly direction); temperature: 80°F, relative humidity: 58 percent.

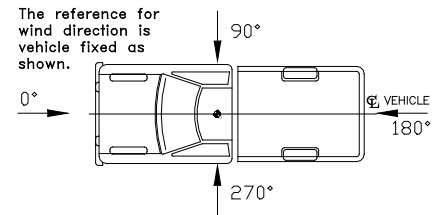

### 5.4 TEST DESCRIPTION

The 2006 Dodge Ram 1500 pickup truck, traveling at an impact speed of 62.6 mi/h, impacted the TxDOT TL-3 Transition 89.0 inches upstream of the concrete parapet at an impact angle of 23.9 degrees. At 0.010 s after impact, the vehicle began to redirect, and at 0.012 s, the three-beam guardrail and posts on either side of impact began to deflect toward the field side. The right front tire contacted the concrete parapet at 0.101 s, and the right front tire and wheel rim separated from the vehicle. At 0.168 s, the vehicle was traveling parallel with the transition at a speed of 52.7 mi/h. The rear of the vehicle contacted the transition at 0.176 s. At 0.316 s, the vehicle lost contact with the transition and was traveling at an exit speed and angle of 52.3 mi/h and 16.2 degrees. As the vehicle exited the transition, it rolled onto its right side and came to rest 208.4 ft downstream of impact and 75.0 ft toward traffic lanes. [Figures E1](#) and [E2](#) in [Appendix E](#) show sequential photographs of the test period.



**Figure 5.1. Vehicle before Test No. 490022-4.**

## 5.5 DAMAGE TO TEST INSTALLATION

Figures 5.2 and 5.3 show damage to the TxDOT TL-3 Transition. The soil was disturbed around post 1 and posts 10 through 12. Post 13 was leaning toward the field side and downstream 0.5 degree (from upright), and there was a gap of 0.25 inch between the edge of the soil and the traffic side of the post. Post 14 was deflected toward the field side 1.12 inches and was leaning 6 degrees toward the field side and 1 degree downstream. Post 15 was deflected toward the field side 1.62 inches and leaning toward field side 6 degrees and downstream 3 degrees. Post 16 was deflected toward the field side 2.0 inches and leaning toward the field side 5 degrees and downstream 7 degrees. Post 17 was deflected toward the field side 1.9 inches and was leaning toward the field side 4 degree and downstream 4 degrees. Post 18 was deflected toward the field side 1.5 inches and leaning toward the field side 5 degrees and downstream 3 degrees. Post 19 was deflected toward the field side 1.4 inches and leaning toward the field side 7 degrees and downstream 6 degrees. Maximum permanent deformation of the thrie beam rail element was 4.5 inches at the top ridge, 3.9 inches at the middle ridge, and 6.5 inches at the bottom ridge. Total length of contact of the vehicle with the thrie beam rail element was 149.0 inches. Working width was 22.8 inches and maximum dynamic deflection of the top of the rail element was 5.9 inches.

## 5.6 VEHICLE DAMAGE

As shown in Figure 5.4, the 2270P vehicle was damaged in the right front and right side. The right frame rail, right front upper and lower A-arms, right front upper and lower ball joints, and right outer tie rods were deformed. Also damaged were the front bumper, hood, grill, right front fender, right front tire and wheel rim, right front door and door glass, right rear door, right exterior bed, rear bumper, tailgate, and right rear wheel rim. Maximum exterior crush to the vehicle was 170.0 inches in the front plane at the right front corner at bumper height. Maximum occupant compartment deformation was 3.75 inches in the lateral area across the occupant compartment in the kickpanel area near the front passenger's feet. Figure 5.5 shows the occupant compartment before and after the test. Tables D3 and D4 of Appendix D present the exterior and interior crush measurement.

## 5.7 OCCUPANT RISK FACTORS

Data from the accelerometer, located at the vehicle center of gravity, were digitized for evaluation of occupant risk. In the longitudinal direction, the occupant impact velocity was 16.4 ft/s at 0.099 s, the highest 0.010-s occupant ridedown acceleration was 14.4 Gs from 0.114 to 0.124 s, and the maximum 0.050-s average acceleration was -8.9 Gs between 0.075 and 0.125 s. In the lateral direction, the occupant impact velocity was 27.6 ft/s at 0.099 s, the highest 0.010-s occupant ridedown acceleration was 9.0 Gs from 0.103 to 0.113 s, and the maximum 0.050-s average was -13.6 Gs between 0.043 and 0.093 s. Theoretical Head Impact Velocity (THIV) was 34.9 km/h or 9.7 m/s at 0.097 s; Post-Impact Head Decelerations (PHD) was 16.2 Gs between 0.114 and 0.124 s; and Acceleration Severity Index (ASI) was 1.63 between 0.044 and 0.094 s. Figure 5.6 summarizes these data and other pertinent information from the test. Vehicle angular displacements and accelerations versus time traces are presented in Appendix F, Figures F1 through F7.



**Figure 5.2. TxDOT TL-3 Transition/Vehicle after Test No. 490022-4.**



**Figure 5.3. TxDOT TL-3 Transition after Test No. 490022-4.**



**Vehicle Immediately after Loss of Contact with the Transition.**



**Vehicle at Final Rest.**

**Figure 5.4. Vehicle after Test No. 490022-4.**



**Figure 5.5. Interior of Vehicle after Test No. 490022-4.**

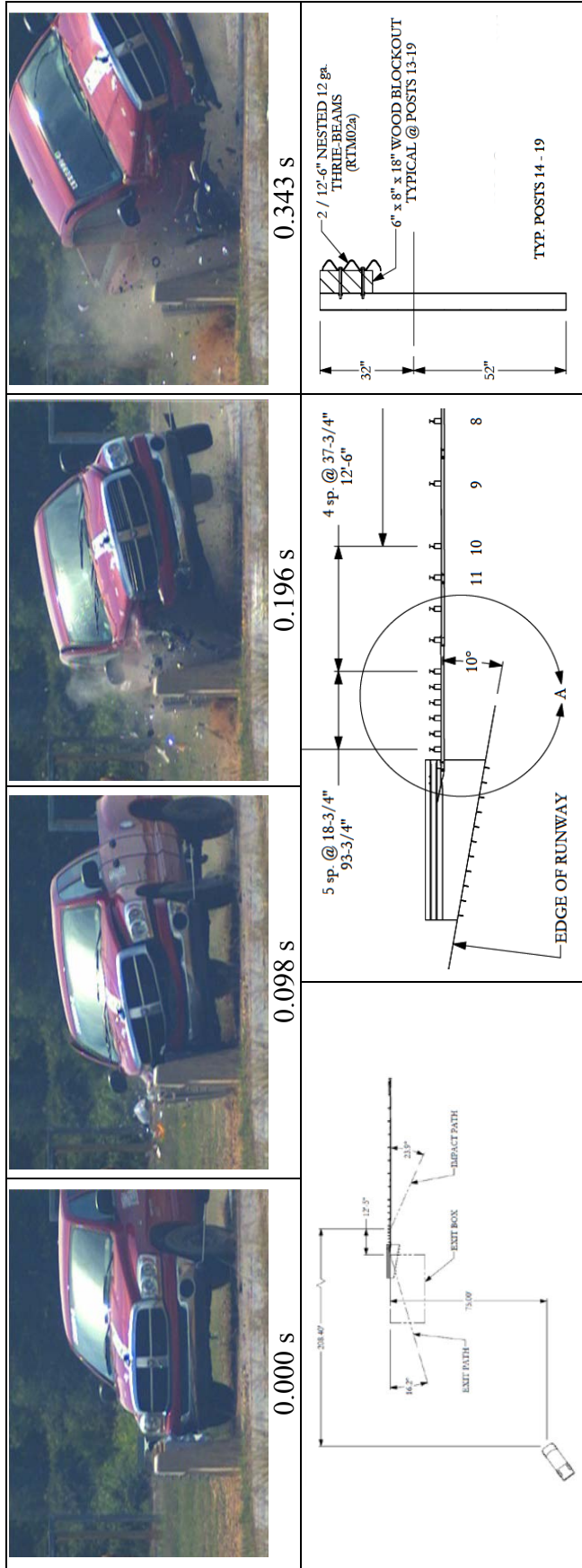

**General Information**

Test Agency ..... Texas A&M Transportation Institute (TTI)  
 Test Standard Test No. .... MASH Test 3-21  
 TTI Test No. .... 490022-4  
 Test Date ..... 2012-05-14

**Test Article**

Type ..... Transition  
 Name ..... TxDOT TL-3 Transition  
 Installation Length ..... 92.5 ft  
 Material or Key Elements ..... Nested 10 gauge thrie beam guardrail on steel posts spaced at 18.75 inches on center

**Soil Type and Condition**

..... Standard Soil, Dry  
 Test Vehicle  
 Type/Designation ..... 2270P  
 Make and Model ..... 2006 Dodge Ram 1500  
 Curb ..... 5026 lb  
 Test Inertial ..... 5002 lb  
 Dummy ..... No dummy  
 Gross Static ..... 5002 lb

**Impact Conditions**

Speed ..... 62.6 mi/h  
 Angle ..... 23.9 degrees  
 Location/Orientation ..... 89 inches upstrm of parapet  
**Exit Conditions**  
 Speed ..... 52.3 mi/h  
 Angle ..... 16.2 degrees

**Occupant Risk Values**

Impact Velocity  
 Longitudinal ..... 16.4 ft/s  
 Lateral ..... 27.6 ft/s  
 Ridedown Accelerations  
 Longitudinal ..... 14.4 G  
 Lateral ..... 9.0 G  
 THIV ..... 34.9 km/h  
 PHD ..... 16.2 G  
 ASI ..... 1.63  
 Max. 0.050-s Average  
 Longitudinal ..... -8.9 G  
 Lateral ..... -13.6 G  
 Vertical ..... -3.1 G

**Post-Impact Trajectory**

Stopping Distance ..... 208.4 ft dwmstr, 75.4 ft twd traffic

**Vehicle Stability**

Maximum Yaw Angle ..... 61 degrees  
 Maximum Pitch Angle ..... 9 degrees  
 Maximum Roll Angle ..... 90 degrees  
 Vehicle Snagging ..... No  
 Vehicle Pocketing ..... No

**Test Article Deflections**

Dynamic ..... 5.9 inches @ top  
 Permanent ..... 6.5 inches @ bottom  
 Working Width ..... 22.8 inches

**Vehicle Damage**

VDS ..... 01FREW4  
 CDC ..... 01RFQ5  
 Max. Exterior Deformation ..... 17.0 inches  
 OCDI ..... RF0010000  
 Max. Occupant Compartment Deformation ..... 3.5 inches

**Figure 5.6. Summary of Results for MASH Test 3-21 on the TxDOT TL-3 Transition.**



## CHAPTER 6. SUMMARY AND CONCLUSIONS

### 6.1 ASSESSMENT OF TEST RESULTS

An assessment of the test based on the applicable *MASH* safety evaluation criteria is provided below.

#### 6.1.1 Structural Adequacy

- A. *Test article should contain and redirect the vehicle or bring the vehicle to a controlled stop; the vehicle should not penetrate, underride, or override the installation although controlled lateral deflection of the test article is acceptable.*

Results: The TxDOT TL-3 Transition contained and redirected the 2270P vehicle. The vehicle did not penetrate, underride, or override the installation. Maximum dynamic deflection of the metal rail element was 7.9 inches. (PASS)

#### 6.1.2 Occupant Risk

- D. *Detached elements, fragments, or other debris from the test article should not penetrate or show potential for penetrating the occupant compartment, or present an undue hazard to other traffic, pedestrians, or personnel in a work zone.*  
*Deformation of, or intrusions into, the occupant compartment should not exceed limits set forth in Section 5.3 and Appendix E of MASH. (roof  $\leq 4.0$  inches; windshield =  $\leq 3.0$  inches; side windows = no shattering by test article structural member; wheel/foot well/toe pan  $\leq 9.0$  inches; forward of A-pillar  $\leq 12.0$  inches; front side door area above seat  $\leq 9.0$  inches; front side door below seat  $\leq 12.0$  inches; floor pan/transmission tunnel area  $\leq 12.0$  inches)*

Results: No detached elements, fragments, or other debris was present to penetrate or show potential for penetrating the occupant compartment, or to present hazard to others in the area. (PASS)  
Maximum occupant compartment deformation was 3.75 inches in the lateral area across the occupant compartment in the kickpanel area near the front passenger's feet. (PASS)

- F. *The vehicle should remain upright during and after collision. The maximum roll and pitch angles are not to exceed 75 degrees.*

Results: The 2270P vehicle rolled 90 degrees onto its right side after exiting the transition. (FAIL)

- H. *Occupant impact velocities should satisfy the following:*
- |  |                |
|--|----------------|
| <i>Longitudinal and Lateral Occupant Impact Velocity</i> |                |
| <u>Preferred</u>   | <u>Maximum</u> |
| 30 ft/s  | 40 ft/s        |

Results: Longitudinal occupant impact velocity was 16.4 ft/s, and lateral occupant impact velocity was 27.6 ft/s. (PASS)

- I. *Occupant ridedown accelerations should satisfy the following:*
- |   |                |
|---|----------------|
| <u>Longitudinal and Lateral Occupant Ridedown Accelerations</u> |                |
| <u>Preferred</u>  | <u>Maximum</u> |
| 15.0 Gs   | 20.49 Gs       |

Results: Longitudinal ridedown acceleration was 14.4 G, and lateral ridedown acceleration was 9.0 G. (PASS)

### 6.1.3 Vehicle Trajectory

*For redirective devices, the vehicle shall exit the barrier within the exit box. Report vehicle rebound distance and velocity for crash cushions.*

Result: The 2270P vehicle exited within the exit box. (PASS)

## 6.2 CONCLUSIONS

The TxDOT TL-3 Transition did not perform acceptably for *MASH* test 3-21 due to vehicle rollover (see [Table 6.1](#)). There were indications of wheel snagging on the end of the concrete parapet that may have contributed to destabilization of the vehicle.

## 6.3 RECOMMENDATIONS\*

The researchers suggest that the following are possible design changes may improve the performance of the system. First, a short curb may be placed at the end of the parapet under the rail to help prevent the wheel snagging. This is consistent with previous design details; however, the researchers feel the length may be reduced to help with the draining problems that prompted this test. Second, the steel blockout at the end of the parapet could be increased in depth to offset the rail to decrease the amount of snagging. Finally, the posts in the nested section of the guardrail could be strengthened by using a larger size post and increasing the embedment depth. This would serve to further stiffen the transition and reduce dynamic deflection. Some previous studies suggest that excessive deflection in the transition region can induce vehicle instability. However, if the system becomes too stiff, the upstream end of the transition section may need to be redesigned and evaluated. Further development, analysis, and full-scale crash testing would be required to evaluate any of these proposed modifications.

---

\* TTI Proving Ground's A2LA scope of accreditation does not cover recommendations. These recommendations were provided by the engineering research team.

**Table 6.1. Performance Evaluation Summary for MASH Test 3-21 on the TxDOT TL-3 Transition.**

Test Agency: Texas A&M Transportation Institute      Test No.: 490022-4      Test Date: 2012-05-14

<b>MASH Test 3-21 Evaluation Criteria</b>	<b>Test Results</b>	<b>Assessment</b>
<p><i>Structural Adequacy</i></p> <p>A. <i>Test article should contain and redirect the vehicle or bring the vehicle to a controlled stop; the vehicle should not penetrate, underide, or override the installation although controlled lateral deflection of the test article is acceptable</i></p>	<p>The TxDOT TL-3 Transition contained and redirected the 2270P vehicle. The vehicle did not penetrate, underide, or override the installation. Maximum dynamic deflection of the metal rail element was 7.9 inches.</p>	<p>Pass</p>
<p><i>Occupant Risk</i></p> <p>D. <i>Detached elements, fragments, or other debris from the test article should not penetrate or show potential for penetrating the occupant compartment, or present an undue hazard to other traffic, pedestrians, or personnel in a work zone.</i></p>	<p>No detached elements, fragments, or other debris was present to penetrate or show potential for penetrating the occupant compartment, or to present hazard to others in the area.</p>	<p>Pass</p>
<p><i>Deformations of, or intrusions into, the occupant compartment should not exceed limits set forth in Section 5.3 and Appendix E of MASH.</i></p>	<p>Maximum occupant compartment deformation was 3.75 inches in the lateral area across the occupant compartment in the kickpanel area near the front passenger's feet.</p>	<p>Pass</p>
<p>F. <i>The vehicle should remain upright during and after collision. The maximum roll and pitch angles are not to exceed 75 degrees.</i></p>	<p>The 2270P vehicle rolled 90 degrees onto its right side after exiting the transition.</p>	<p>Fail</p>
<p>H. <i>Longitudinal and lateral occupant impact velocities should fall below the preferred value of 30 ft/s, or at least below the maximum allowable value of 40 ft/s.</i></p>	<p>Longitudinal occupant impact velocity was 16.4 ft/s, and lateral occupant impact velocity was 27.6 ft/s.</p>	<p>Pass</p>
<p>I. <i>Longitudinal and lateral occupant ridedown accelerations should fall below the preferred value of 15.0 Gs, or at least below the maximum allowable value of 20.49 Gs.</i></p>	<p>Longitudinal ridedown acceleration was 14.4 G, and lateral ridedown acceleration was 9.0 G.</p>	<p>Pass</p>
<p><i>Vehicle Trajectory</i></p> <p><i>For redirective devices, the vehicle shall exit the barrier within the exit box (not less than 32.8 ft).</i></p>	<p>The 2270P vehicle exited within the exit box.</p>	<p>Pass</p>



## CHAPTER 7. IMPLEMENTATION STATEMENT

The modified transition system without curb did not meet the impact performance requirements of *MASH*. Consequently, no implementation is recommended at this time. Several possible design modifications are presented to mitigate the vehicle instability observed in the test. One or more of these modifications can be analyzed and evaluated at the discretion of TxDOT.



## REFERENCES

1. H. E. Ross, D. L. Sicking, R. A. Zimmer, and J. D. Michie. "Recommended Procedures for the Safety Performance Evaluation." *NCHRP Report 350*. National Academy Press, Washington, D.C., National Cooperative Highway Research Program, 1993.
2. AASHTO, *Manual for Assessing Safety Hardware*, American Association of State Highway and Transportation Officials, Washington, D.C., 2009.





# APPENDIX A. DETAILS OF THE TXDOT TL-3 TRANSITION

I:\2011-2012\490022 TXDOT\4 TL-3 Transition\Drawings\TL-3 Installation

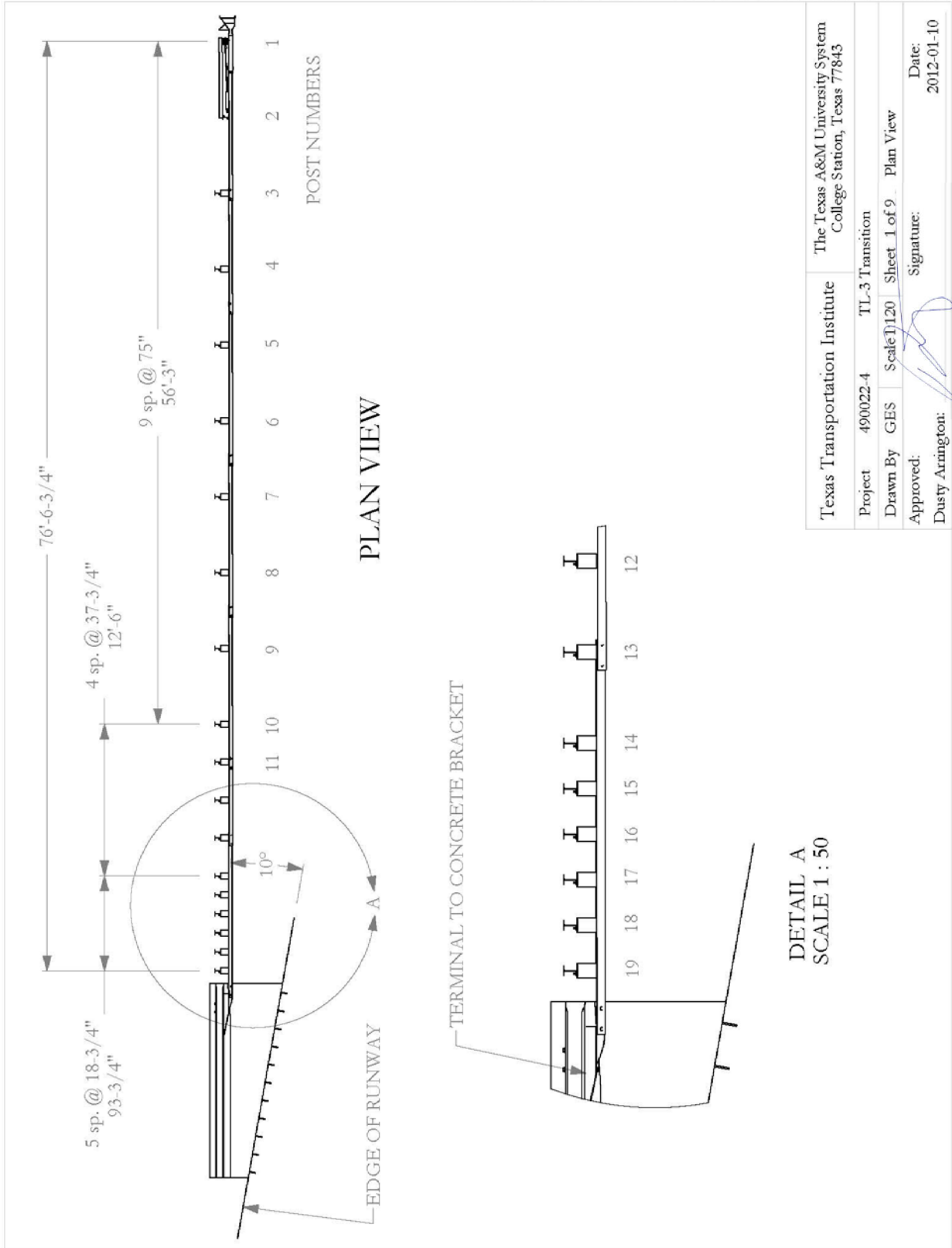

Texas Transportation Institute	The Texas A&M University System College Station, Texas 77843
Project 490022-4	TL-3 Transition
Drawn By GES	Scale 1/20 Sheet 1 of 9 Plan View
Approved: Dusty Arrington:	Signature: 
	Date: 2012-01-10

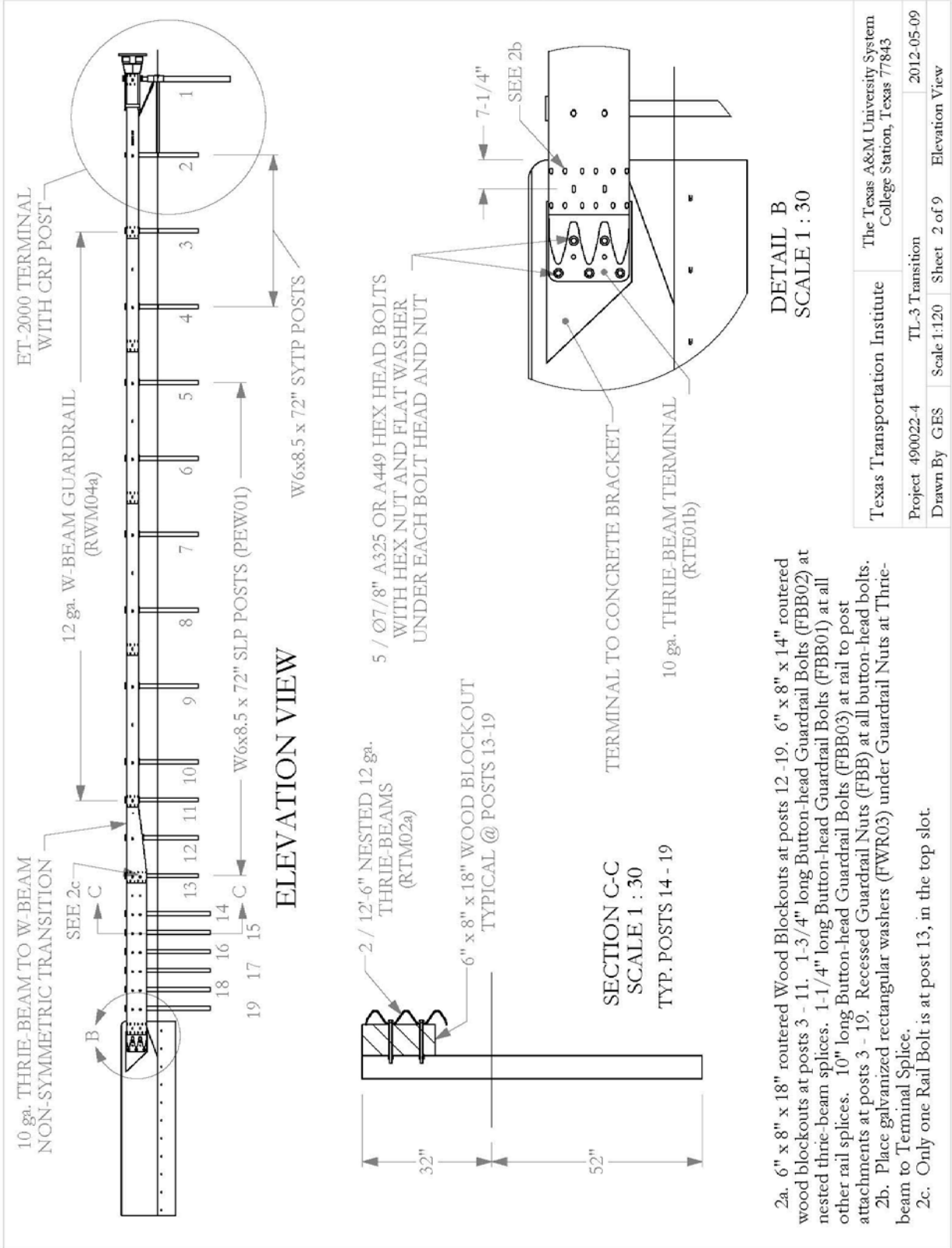

2a. 6" x 8" x 18" routed Wood Blockouts at posts 12 - 19. 6" x 8" x 14" routed wood blockouts at posts 3 - 11. 1-3/4" long Button-head Guardrail Bolts (FBB02) at nested thrie-beam splices. 1-1/4" long Button-head Guardrail Bolts (FBB01) at all other rail splices. 10" long Button-head Guardrail Bolts (FBB03) at rail to post attachments at posts 3 - 19. Recessed Guardrail Nuts (FBB) at all button-head bolts.

2b. Place galvanized rectangular washers (FWR03) under Guardrail Nuts at Thrie-beam to Terminal Splice.

2c. Only one Rail Bolt is at post 13, in the top slot.

Texas Transportation Institute	The Texas A&M University System College Station, Texas 77843
Project 490022-4	TL-3 Transition
Drawn By GES	Scale 1:120 Sheet 2 of 9 Elevation View
	2012-05-09

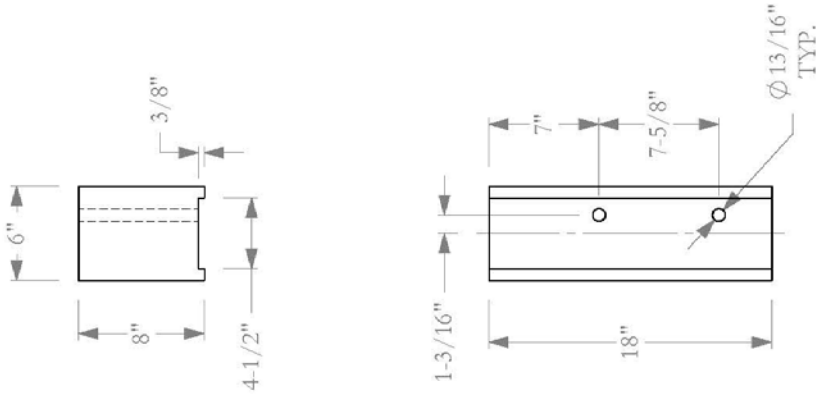

**6" x 8" x 18" BLOCKOUT**  
TYP. POSTS 12 - 19

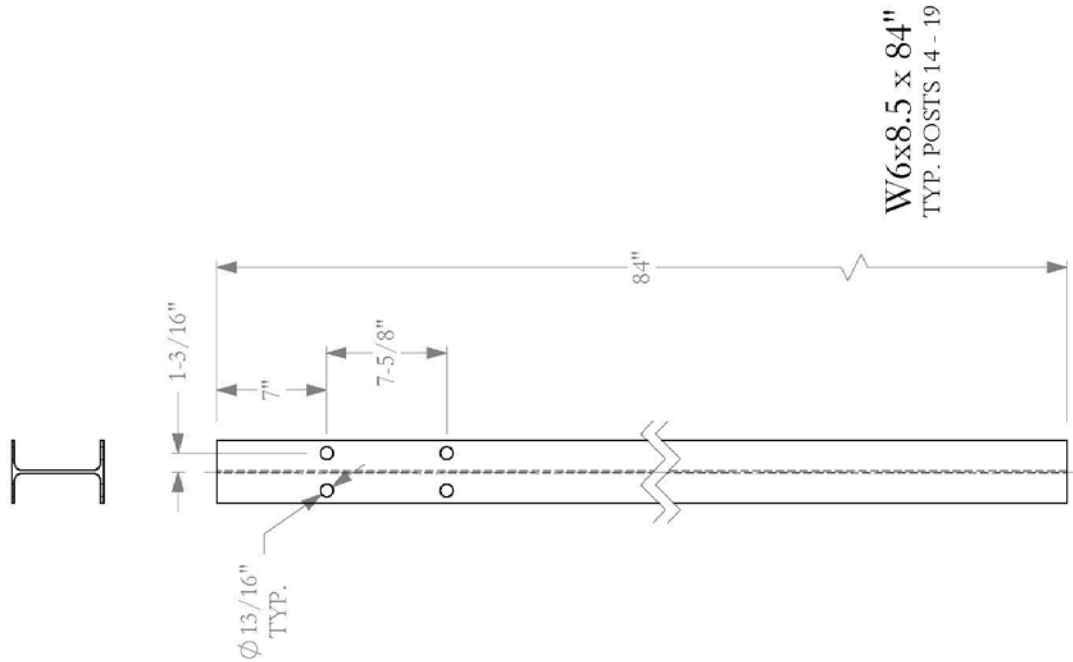

**W6x8.5 x 84"**  
TYP. POSTS 14 - 19

Texas Transportation Institute	The Texas A&M University System College Station, Texas 77843
Project 490022-4	2012-05-09
Drawn By GES	TL-3 Transition
Scale 1:10	Sheet 3 of 9
Part Details	

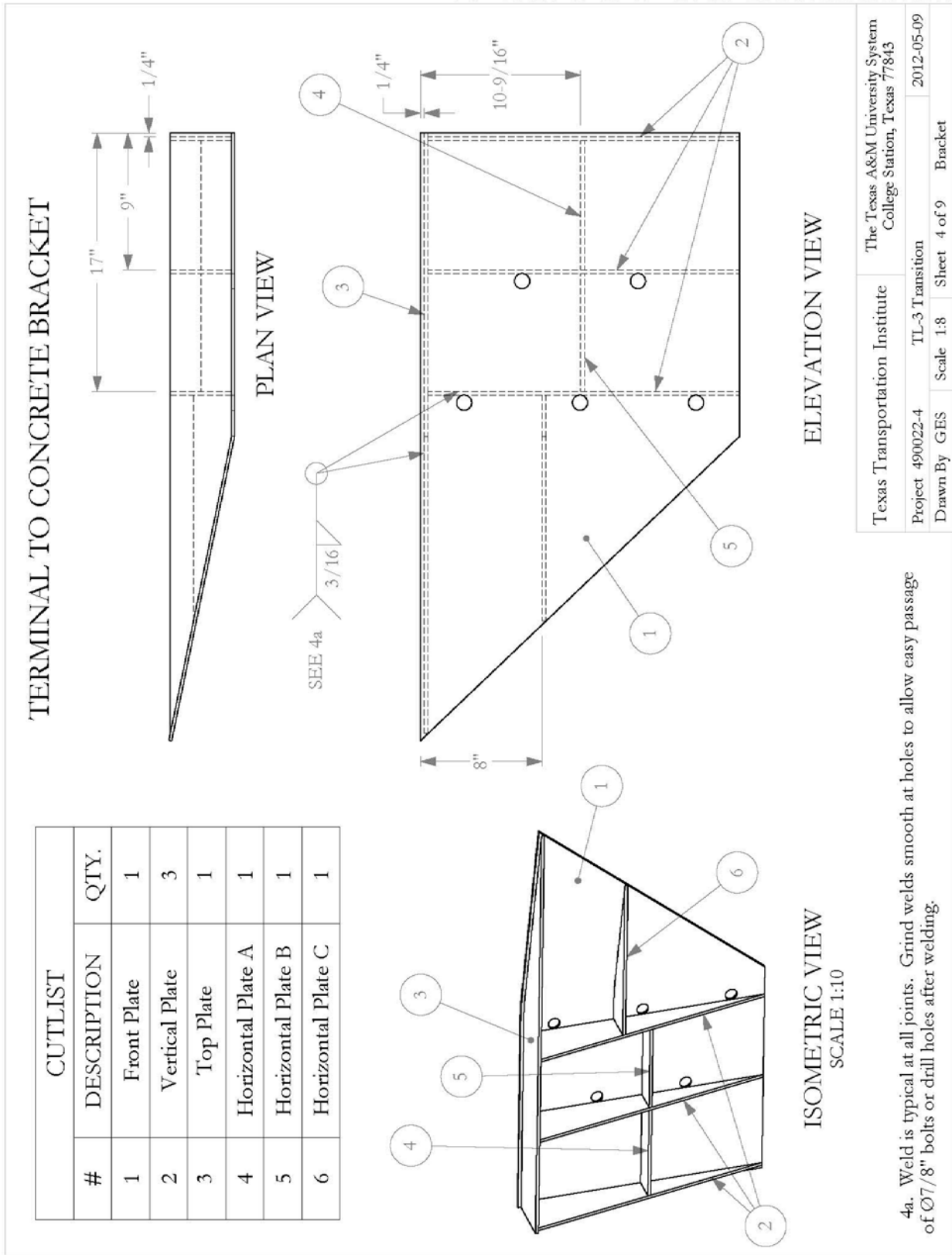

Texas Transportation Institute	The Texas A&M University System College Station, Texas 77843	
Project 490022-4	TL-3 Transition	2012-05-09
Drawn By GES	Scale 1:8	Sheet 4 of 9 Bracket

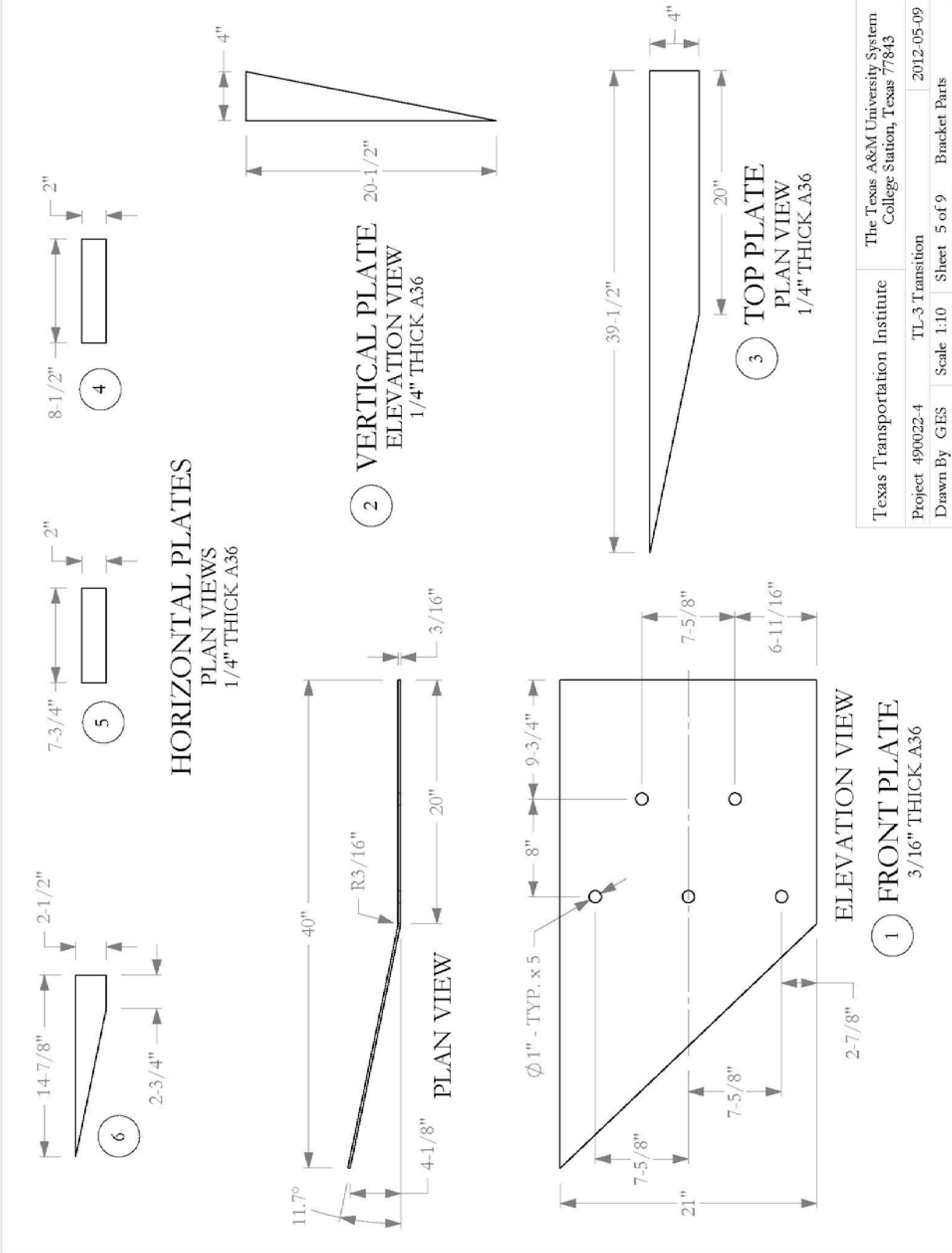

Texas Transportation Institute	The Texas A&M University System College Station, Texas 77843
Project 490022-4	TL-3 Transition
Drawn By GES	Scale 1:10 Sheet 5 of 9 Bracket Parts
2012-05-09	

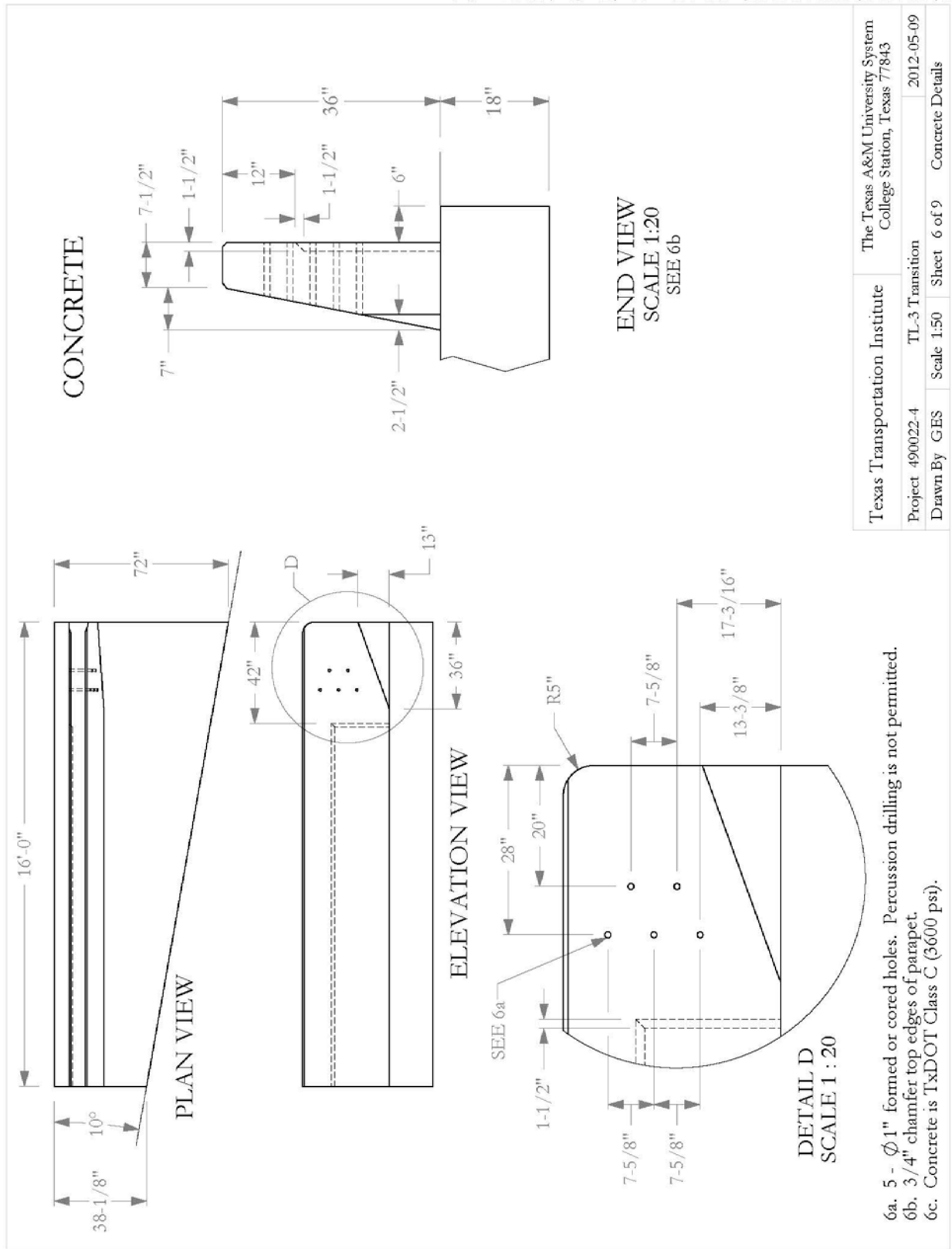

T:\2011-2012\490022 TxDOT\4 TL-3 Transition\Drafting\TL-3 Installation

Texas Transportation Institute	The Texas A&M University System College Station, Texas 77843
Project 490022.4	TL-3 Transition
Drawn By GES	Scale 1:50 Sheet 6 of 9 Concrete Details
	2012-05-09

- 6a. 5 - Ø 1" formed or cored holes. Percussion drilling is not permitted.
- 6b. 3/4" chamfer top edges of parapet.
- 6c. Concrete is TxDOT Class C (3600 psi).

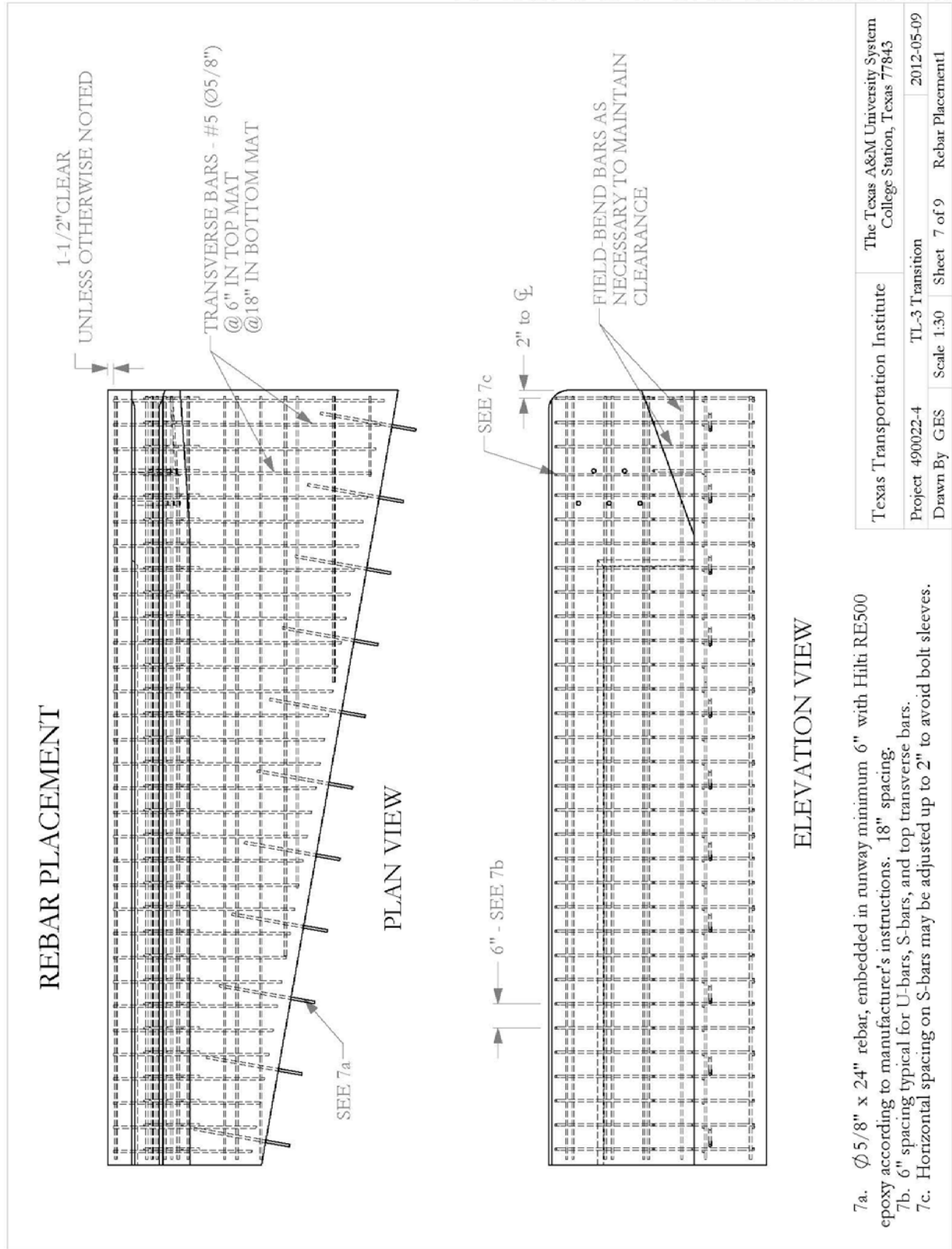

- 7a.  $\phi$  5/8" x 24" rebar, embedded in runway minimum 6" with Hilti RE500 epoxy according to manufacturer's instructions. 18" spacing.
- 7b. 6" spacing typical for U-bars, S-bars, and top transverse bars.
- 7c. Horizontal spacing on S-bars may be adjusted up to 2" to avoid bolt sleeves.

Texas Transportation Institute	The Texas A&M University System College Station, Texas 77843
Project 490022-4	TL-3 Transition
Drawn By GES	Scale 1:30
Sheet 7 of 9	Rebar Placement
2012-05-09	

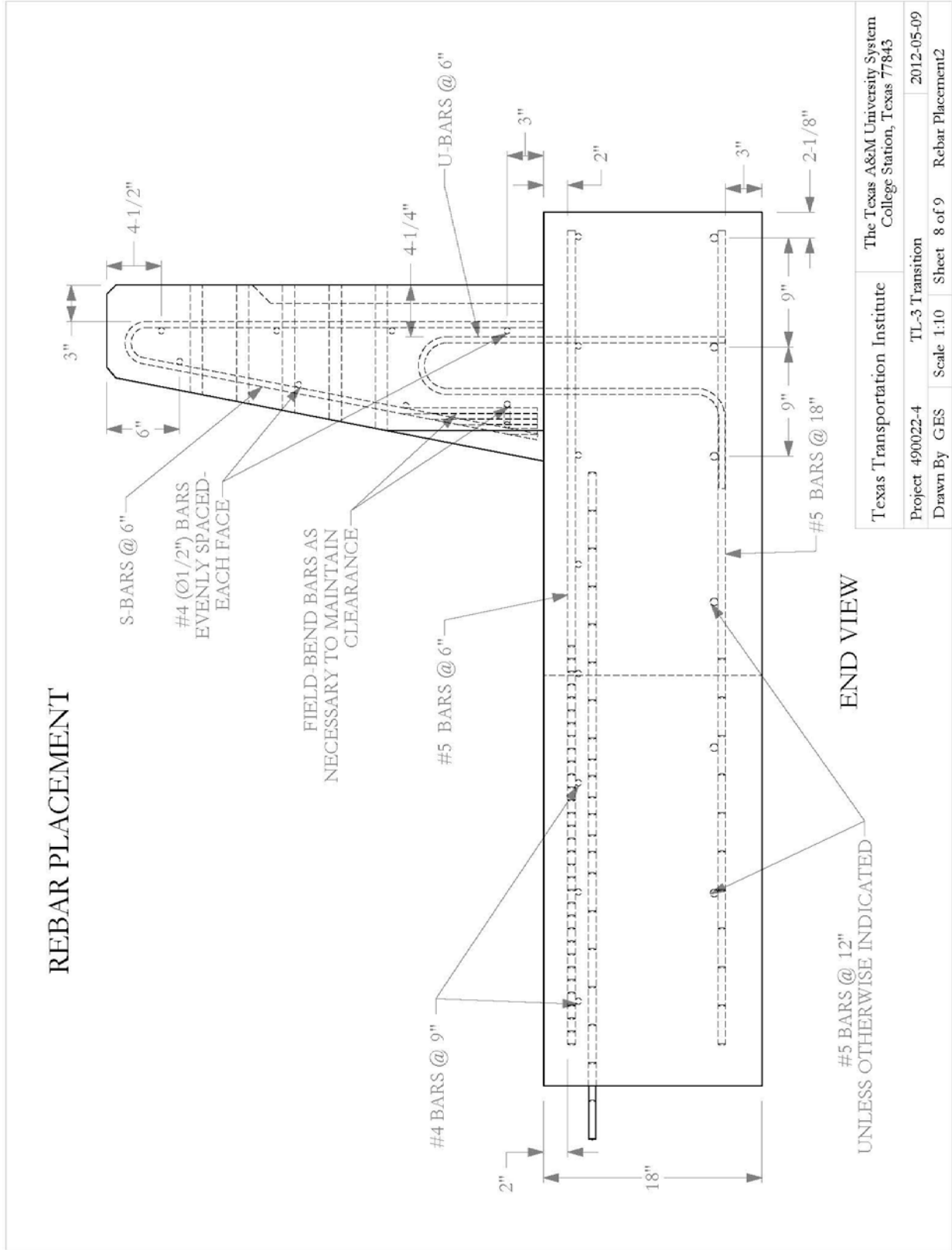

T:\2011-2012\490022 T&DOT\4 TL-3 Transition\Drafting\TL-3 Installation



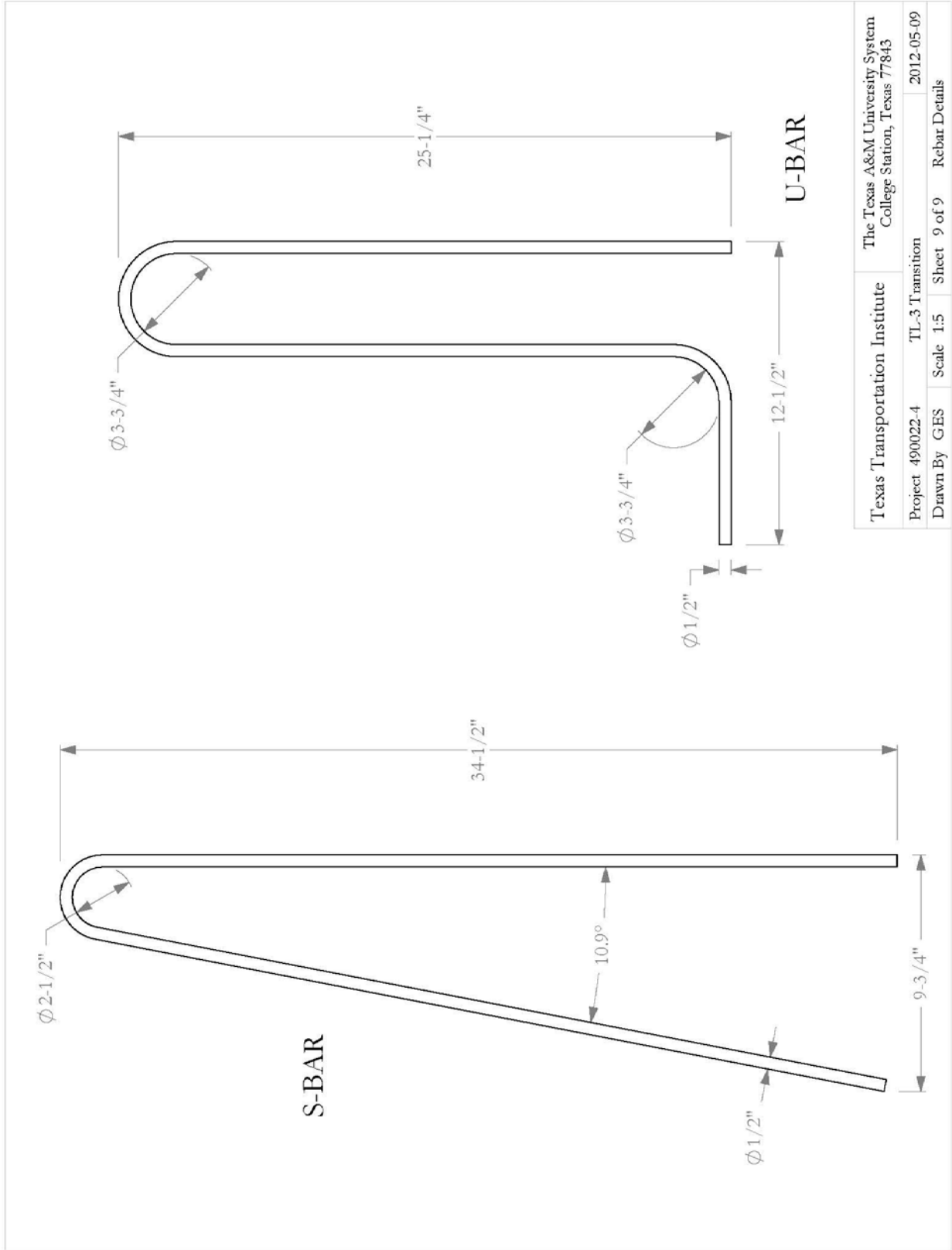

T:\2011-2012\490022 TXDOT\4 TL-3 Transition\Drafting\TL-3 Installation

Texas Transportation Institute	The Texas A&M University System College Station, Texas 77843
Project 490022-4	2012-05-09
Drawn By GES	TL-3 Transition
Scale 1:5	Sheet 9 of 9
Rebar Details	



## APPENDIX B. CERTIFICATION DOCUMENTATION

		MATERIAL USED		
TEST NUMBER	490022-4			
TEST NAME	TL-3 Transition			
DATE	2012-05-14			
DATE RECEIVED	ITEM NUMBER	DESCRIPTION	SUPPLIER	HEAT #
2012-02-08	Parts-16	Guardrail Parts	Trinity	see file
2012-02-23	Rebar 04-26	1/2" x 20' gr 60	CMC-Sheplers	3029770
2012-02-23	Rebar 05-15	5/8" x 20' grd 60	CMC-Sheplers	3028494

**This Memorandum**

is an acknowledgment that a Bill of Lading has been issued and is not the original Bill of Lading, nor a copy or duplicate, covering the property named herein, and is intended solely for filing or record.

Carrier: **16-40479**  
 Shipper's No. **1164772**  
 S/O No. **1164772**  
 Received, subject to the classifications and tariff in effect on the date of receipt by the carrier of the property described in this Original Bill of Lading, at **Waco, TX** on **2/11/12** from **Trinity Highway Products, LLC** 9  
 the property described below in accordance with the conditions of contracts of purchase, shipment, carriage and delivery as stated herein, which said contracts comprise the terms, conditions, notices, receipts and delivery of the property named herein, and as to any other conditions, notices, receipts or delivery of the property named herein, the carrier shall be held harmless, and as to any other conditions, notices, receipts or delivery of the property named herein, the carrier shall be held harmless, and as to any other conditions, notices, receipts or delivery of the property named herein, the carrier shall be held harmless.

Subject to Section 7 of Conditions of applicable Bill of Lading, if this shipment is to be delivered to the consignee without recourse on the consignor, the consignor shall sign the following statement:  
 The carrier shall not make delivery of this shipment without payment of freight and all other lawful charges.

Consigned to: **SAMPLES TESTING TRAINING MTRLS** Cust. P.O. **TTI-ET 2000** Load No **96-1**  
 Destination: **TTI - ATTN: GARY GERKE** **3100 STATE HWY 47** Total Weight: **896.97**  
**SAFETY & STRUCT. SYST. DIV.** **BLDG. 7090**

City: **BRYAN** State: **TX** Zip: **77907** Ship: **2/7/12**  
 Arrive: **2/8/12 8:00:00AM**

Contact: **Gary Gerke** Phone: **936-825-4661** **513268**

Delivering Carrier: **FedEx FX FE** Vehicle or Car Initial: \_\_\_\_\_ No. \_\_\_\_\_

Collect On Delivery:  C.O.D. charge Shipper  
 and remit to: \_\_\_\_\_ to be paid by Consignee  
 Street \_\_\_\_\_ City \_\_\_\_\_ State \_\_\_\_\_

**TRINITY HIGHWAY PRODUCTS, LLC**  
**Trinity Highway Products, LLC**  
 (Signature of Consignor)

If charges are to be prepaid, write or stamp here: "To be Prepaid."  
**TO BE PREPAID**

Received \$ \_\_\_\_\_  
 to apply in prepayment of the charges on the property described hereon.

Agent or Cashier \_\_\_\_\_

Per \_\_\_\_\_  
 (The signature here acknowledges only the amount prepaid.)  
 Charges advanced: \_\_\_\_\_

No. Pkgs.	Piece Count	Description of Articles	Wt.	Class or Rate	Col.	No. Pkgs.	Piece Count	Description of Articles	Wt.	Class or Rate	Col.
Upon delivery, all materials subject to Trinity Highway Products, LLC Storage Stain Policy No. LG-002.											
Project info: <b>SAMPLES &amp; TESTING TTI ET-2000 OIL CHRIST/SHRB COURTYARD</b>											
2		32G 12/12*6*3/8 ET2000 ANC				2	33795G	SYT-3"AN STRT 3-HL 66			
2		704A CABLE ANCHOR BRKT									
2		3600G CBL 3/4X6*6/DL									
22		3340G 5/8" OR HEX NUT									
18		3350G 5/8"X1.25" GR BOLT									
4		3500G 5/8"X10" GR BOLT A307									
4		3701G 3/4" ROUND WASHER F436									
4		3704G 3/4" HVY HEX NUT A563 DH									
4		3717G 3/4"X2.5" HEX BOLT A325									
4		3900G 1" ROUND WASHER F844									
4		3910G 1" HEX NUT A563									
4		4076B WD BLK RTD 6X8X14									
8		4254G 3/8" ROUND WASHER F436									
4		4255G 3/8" FENDER WASHER F844									
4		4258G 3/8" LOCK WASHER									
4		4261G 3/8"X1.5" HEX BOLT GR-5									
4		4389G 7/16" WASHER F844									
4		4390G 7/16"X1.5" HEX BOLT GRD 5									
4		4393G 7/16" LOCK WASHER									
4		4396G 7/16" HEX NUT A563 DH									
4		4699G 3/4" LOCK WASHER									
4		6321G 3/8"X2" HEX BOLT GR-5 HDG									
8		6405G 3/8" HVY HEX NUT									
2		10967G 12/9*4.5/3" 5/8									
6		13000G 60 SYT PST/8.5/31" GR HT									
2		19258A HEA-BRO PL/WELDED TABS									
4		19948G .135(10G)X1.75X1.75 WSHR									

**1 - CRATE**  
**1 - BUNDLE**  
**2 - PHILLES**  
**GUARDRAIL HWY STEEL**  
**NMFC ITEM 105460**  
**CLASS 50**

SPECIAL INSTRUCTIONS: **SHIPPER LOAD - CONSIGNEE UNLOAD** **16-40479** **Total Weight** **896** **3**

\*If the shipment (moves between two ports by a carrier) by water, the law requires that the bill of lading shall state whether it is "carrier's or shipper's weight."  
 NOTE - Where the rate is dependent on value, shippers are required to state specifically in writing the agreed or declared value of the property.  
 The agreed or declared value of the property is hereby specifically stated by the shipper to be not exceeding \_\_\_\_\_  
 OR AGENT I hereby authorize the shipment and make the declaration of value (if any) and agree to the contract terms and conditions hereof. DATE: **2/11/12**  
 OR DRIVER This shipment received subject to exceptions as noted and according to the terms and conditions hereof. DATE: \_\_\_\_\_  
 OR DRIVER DATE: \_\_\_\_\_

Permanent post-office address of shipper: \_\_\_\_\_  
 (This Bill of Lading is to be signed by the shipper and agent of the carrier issuing same.) **CONSIGNEE/CUSTOMER COPY**

**This Memorandum**

is an acknowledgment that a Bill of Lading has been issued and is not the original Bill of Lading, nor a copy or duplicate, covering the property named herein, and is intended solely for filing or record.

Carrier: **Trinity Highway Products, LLC**  
 Shipper's No.: **16-40480**  
 S/O No.: **1164715**  
 Received subject to the classifications and tariffs in effect on the date of receipt by the carrier of the property described in the Original Bill of Lading at **Fort Worth, TX** on **2/17/12** from **Trinity Highway Products, LLC** in **3** pieces.  
 The property described below, in apparent good order, except as noted (contents and condition of packages unknown), packed, counted and declared as shown below, which said company the ware company being understood throughout this bill of lading as having any person or corporation in possession of the property under the contract, agrees to carry to its final place of delivery, at said destination, if on its own railroad, water line, highway route or route, or within the territory of its highway business, otherwise to deliver to another carrier on the route to said destination. It is mutually agreed, as to each carrier of all or any of said property, that the carrier of said property shall be liable to the conditions not prohibited by law, whether printed or written, herein contained, including the conditions of back-haul, which are hereby agreed to by the shipper and accepted for forward and his assigns.

Consigned to: **SAMPLES, TESTING, TRAINING MTRLS** Cust. P.O. **Samples** Load No.: **96-2**  
 Destination: **ATTN: GARY GERKE** **3100 STATE HWY 47**  
**SAFETY & STRUCT. SYST. DIV.** **BLDG. 7090** Total Weight: **3,971.83**

City: **Bryan** State: **TX** Zip: **77817** Ship: **2/7/12**  
 Arrive: **2/8/12 8:00:00AM**

Contact: **Gary Gerke** Phone: **936-825-4661**  
 Delivering Carrier: **FedEx EX 1E** Vehicle or Car Initial: **32926** No.

Collect On Delivery:  C.O.D. charge Shipper   
 \$ \_\_\_\_\_ and remit to: \_\_\_\_\_ to be paid by Consignee   
 Street \_\_\_\_\_ City \_\_\_\_\_ State \_\_\_\_\_

Subject to Section 7 of Conditions of applicable Bill of Lading, if this shipment is to be delivered to the consignee without recourse on the consignor, the consignor shall sign the following statement:  
 The carrier shall not make delivery of this shipment without payment of freight and all other lawful charges.  
**TRINITY HIGHWAY PRODUCTS, LLC**  
 Per: \_\_\_\_\_  
 (Signature of Consignor)  
 If charges are to be prepaid, write or stamp here: **To be Prepaid**  
**TO BE PREPAID**  
 Received \$ \_\_\_\_\_  
 to apply in prepayment of the charges on the property described herein.  
 Agent or Cashier \_\_\_\_\_  
 Per: \_\_\_\_\_  
 (The signature here acknowledges only the amount prepaid.)  
 Charges advanced: \_\_\_\_\_

No. Pkgs.	Piece Count	Inventory, all units	Description of Goods	Mod.	Class or Rate	Col.	No. Pkgs.	Piece Count	Inventory, all units	Description of Articles	Wt.	Class or Rate	Col.
Project Info: <b>SAMPLES &amp; TESTING TRAINING MTRLS</b>													
6	110	12/126/31.5/S											
14	533G	60 POST/8.5/DR											
2	980G	T10/END SHOE/SLANT 1"HO.											
42	3300G	5/8" RD WASHER 1 3/4 OD											
24	3320G	3/16"X1.75"X3" WASHER											
154	3340G	5/8" GR HEX NUT											
64	3360G	5/8"X1.25" GR BOLT											
48	3400G	5/8"X2" GR BOLT											
42	3500G	5/8"X10" GR BOLT A307											
10	3725G	7/8" WASHER F844 TYPE A/N											
10	3735G	7/8" HEX NUT A-563											
14	4076B	WD BLK RTD 6X8X14											
16	6149B	WD BLK RTD 6X8X18											
10	6900G	7/8"X15.5" HXBLT A449 5" T											
4	12227G	T12/126/31.5:6@16.75/B											
12	14784G	70 POST/8.5#3HI TX											
2	14785G	60 POST/8.5#3HI TX											
2	14786G	60 POST/8.5#TRANS TX											
2	32218G	T10/TRAN/TB:WB/ASYM/RT											
2	33247A	CONN PL 40"X20" RT MO											
<b>1 CRATE</b>													
<b>GUARDRAIL HWY STEEL</b>													
<b>NMFC ITEM 105460</b>													
<b>CLASS 50</b>													
<b>16-40480</b>													

**SPECIAL INSTRUCTIONS:**  
**SHIPPER LOAD - CONSIGNEE UNLOAD**  
 # **Total Weight** **3**  
 3,971  
 If the shipment moves between two ports by a carrier by water, the law requires that the bill of lading shall state whether it is "carrier's or shipper's weight."  
 NOTE - Where the rate is dependent on value, shippers are required to state specifically in writing the agreed or declared value of the property. The agreed or declared value of the property is hereby specifically stated by the shipper to be not exceeding \_\_\_\_\_ per \_\_\_\_\_  
 SHIPPER OR AGENT: I hereby authorize the shipment and make the declaration of value (if any) and agree to the contract terms and conditions hereof.  
 CONSIGNEE OR AGENT: Received the above described property in good condition except as noted on the back hereof and agree to the foregoing contract terms and conditions.  
 ORIGIN: SIGN HERE DATE: **2/7/12**  
 DESTINATION: SIGN HERE DATE: \_\_\_\_\_ TIME: \_\_\_\_\_  
 (S/GN HERE) DATE: \_\_\_\_\_ DRIVER: \_\_\_\_\_ NO: \_\_\_\_\_  
 Permanent post-office address of shipper: \_\_\_\_\_  
 (FBI 808-RF (R 10/93)) (This Bill of Lading is to be signed by the shipper and agent of the carrier issuing same.) **CONSIGNEE/CUSTOMER COPY**

Trinity Highway Products, LLC  
 2548 N.E. 28th St.  
 Ft Worth, TX 76111



Customer: SAMPLES, TESTING, TRAINING MTRLS  
 2525 STEMMONS FRWY

Sales Order: 1164772  
 Customer PO: TTI-ET 2000  
 BOL # 40479  
 Document # 1

Print Date: 2/7/12  
 Project: SAMPLES & TESTING TTI ET-2000 GILCHRIST/SHI  
 Shipped To: TX  
 Use State: TX

DALLAS, TX 75207

Trinity Highway Products, LLC  
 Certificate Of Compliance For Trinity Industries, Inc. \*\* E.T. PLUS EXTRUDER TERMINAL \*\*  
 NCHRP Report 350 Compliant

Pieces	Description	Part No
2	12/12/6'3/S ET2000 ANC	000032G
2	CABLE ANCHOR BRKT ET-2000	000704A
2	CBL 3/4X6/6/DBL SWG/NOHWD	003000G
22	5/8" GR HEX NUT	003340G
18	5/8"X1.25" GR BOLT	003360G
4	5/8"X10" GR BOLT A307	003500G
4	3/4" ROUND WASHER F436	003701G
4	3/4" HVY HEX NUT A563 DH	003704G
4	3/4"X2.5" HEX BOLT A325	003717G
4	1" ROUND WASHER F844	003900G
4	1" HEX NUT A563	003910G
4	WD BLK RTD 6X8X14	004076B
8	3/8" ROUND WASHER F436	004254G
4	3/8" FENDER WASHER F844	004255G
4	3/8" LOCK WASHER	004258G
4	3/8"X1.5" HEX BOLT GR-5	004261G
4	7/16" WASHER F844	004389G
4	7/16"X1.5" HEX BOLT GRD 5	004390G
4	7/16" LOCK WASHER	004393G
4	7/16" HEX NUT A563 DH	004396G
4	3/4" LOCK WASHER	004699G
4	3/8"X2" HEX BOLT GR-5 HDG	006321G
8	3/8" HVY HEX NUT A563GRDH	006405G
2	12/9/4.5/3/1.5/S	010967G
6	60 SYT PST/8.5/31" GR HT	015000G
2	HBA-BRG PL/WELDED TABS	019258A
4	.135(10Ga)X1.75X1.75 WSHR	019948G
2	SYT-3"AN STRT 3-HL 6/6	033795G



Trinity Highway Products, LLC  
2548 N.E. 28th St.  
Ft Worth, TX 76111

Customer: SAMPLES, TESTING, TRAINING MTRLS  
2525 STEMMONS FRWY  
DALLAS, TX 75207  
Sales Order: 1164772  
Customer PO: TTI-ET 2000  
BOL # 40479  
Document # 1  
Print Date: 2/7/12  
Project: SAMPLES & TESTING TTI ET-2000 GILCHRIST/SHI  
Shipped To: TX  
Use State: TX

Trinity Highway Products, LLC  
Certificate Of Compliance For Trinity Industries, Inc. \*\* E.T. PLUS EXTRUDER TERMINAL \*\*  
NCHRP Report 350 Compliant

Upon delivery, all materials subject to Trinity Highway Products, LLC Storage Stain Policy No. LG-002.  
TL -3 or TL-4 COMPLIANT when installed according to manufactures specifications

ALL STEEL USED WAS MELTED AND MANUFACTURED IN USA AND COMPLIES WITH THE BUY AMERICA ACT  
ALL GUARDRAIL MEETS AASHTO M-180, ALL STRUCTURAL STEEL MEETS ASTM A36  
ALL COATINGS PROCESSES OF THE STEEL OR IRON ARE PERFORMED IN USA AND COMPLIES WITH THE "BUY AMERICA ACT"  
ALL GALVANIZED MATERIAL CONFORMS WITH ASTM-123, UNLESS OTHERWISE STATED.  
BOLTS COMPLY WITH ASTM A-307 SPECIFICATIONS AND ARE GALVANIZED IN ACCORDANCE WITH ASTM A-153, UNLESS OTHERWISE STATED.  
NUTS COMPLY WITH ASTM A-563 SPECIFICATIONS AND ARE GALVANIZED IN ACCORDANCE WITH ASTM A-153, UNLESS OTHERWISE STATED.  
WASHERS COMPLY WITH ASTM F-436 SPECIFICATION AND/OR F-844 AND ARE GALVANIZED IN ACCORDANCE WITH ASTM F-2329.  
3/4" DIA CABLE 6X19 ZINC COATED SWAGED END AISI C-1035 STEEL ANNEALED STUD 1" DIA ASTM 449 AASHTO M30, TYPE II BREAKING STRENGTH --49100LB

State of Texas, County of Tarrant. Sworn and Subscribed before me this 7th day of February, 2012

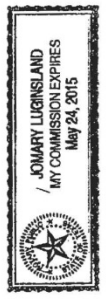

Notary Public:  
Commission Expires:

*Jonary Luginland*

Trinity Highway Products, LLC  
Certified By: *Quinn O'Leary*  
Quality Assurance



# Certified Analysis

Trinity Highway Products, LLC  
 2548 N.E. 28th St.  
 Ft Worth, TX 76111

Order Number: 1164715  
 Customer PO: Samples  
 BOL Number: 40480

Customer: SAMPLES, TESTING, TRAINING MTRLS  
 2525 STEMMONS FRWY

As of: 2/7/12

Document #: 1  
 Shipped To: TX  
 Use State: TX

DALLAS, TX 75207  
 Project: SAMPLES & TESTING TRAINING MTRLS

Qty	Part #	Description	Spec	CL	TY	Heat Code/Heat #	Yield	TS	Elg	C	Mn	P	S	Si	Cu	Ch	Cr	Vn	ACW
6	11G	12/12/63/1.5/S	A-300		2	202248	53,600	75,500	29.0	0.190	0.780	0.011	0.020	0.120	0.120	0.00	0.050	0.002	4
			M-180	A	2	101800	50,000	73,300	30.0	0.190	0.750	0.012	0.002	0.020	0.120	0.000	0.070	0.002	4
			M-180	A	2	101802	51,800	74,700	29.0	0.190	0.770	0.009	0.002	0.020	0.120	0.000	0.050	0.002	4
			M-180	A	2	101804	54,500	75,800	28.0	0.190	0.800	0.011	0.002	0.020	0.120	0.000	0.050	0.002	4
			M-180	A	2	102475	58,700	79,800	25.0	0.200	0.820	0.010	0.010	0.007	0.130	0.000	0.050	0.000	4
			M-180	A	2	102476	58,100	77,900	26.0	0.190	0.750	0.009	0.001	0.020	0.130	0.000	0.060	0.002	4
			M-180	A	2	202249	51,800	74,500	30.0	0.190	0.790	0.010	0.002	0.020	0.120	0.000	0.050	0.002	4
			M-180	A	2	202250	54,100	76,100	27.0	0.200	0.820	0.012	0.002	0.020	0.120	0.000	0.050	0.003	4
			M-180	A	2	202938	57,600	80,400	25.0	0.190	0.830	0.009	0.001	0.020	0.130	0.000	0.050	0.003	4
			M-180	A	2	202939	56,800	78,400	25.0	0.190	0.770	0.009	0.004	0.020	0.130	0.000	0.050	0.003	4
14	533G	60 POST/8.5/DDR	A-36			1017017	53,642	71,899	26.8	0.110	0.960	0.008	0.038	0.180	0.260	0.00	0.090	0.004	4
			A-36			1017007	53,613	72,244	25.7	0.120	0.930	0.012	0.040	0.180	0.360	0.00	0.140	0.003	4
			A-36			1016666	56,666	73,288	29.7	0.110	0.940	0.013	0.037	0.190	0.320	0.00	0.150	0.004	4
			A-36			1017003	55,742	71,204	24.3	0.100	0.950	0.014	0.046	0.180	0.300	0.00	0.160	0.004	4
2	980G	T10/END SHOE/SLANT	A-36			125745	58,100	66,100	31.9	0.050	0.570	0.012	0.003	0.030	0.100	0.01	0.050	0.000	4
4	12227G	T12/12/63/1.5/6@16.75/S	M-180	A	2	150054	61,580	80,600	25.0	0.190	0.720	0.010	0.003	0.010	0.130	0.00	0.060	0.001	4
12	14784G	70 POST/8.5#/3HI TX	A-36			1014849	50,787	69,032	25.6	0.100	0.960	0.015	0.037	0.180	0.310	0.00	0.180	0.003	4
			A-36			1014844	53,141	69,983	28.3	0.110	0.960	0.010	0.037	0.180	0.330	0.00	0.110	0.003	4
			A-36			1014840	57,069	73,001	30.4	0.110	0.960	0.010	0.035	0.170	0.320	0.00	0.150	0.004	4





# Certified Analysis

Trinity Highway Products, LLC  
 2548 N.E. 28th St.  
 Ft Worth, TX 76111

Customer: SAMPLES, TESTING, TRAINING MTRLS  
 2525 STEMMONS FRWY

DALLAS, TX 75207

Project: SAMPLES & TESTING TRAINING MTRLS

Order Number: 1164715

Customer PO: Samples

BOL Number: 40480

Document #: 1

Shipped To: TX

Use State: TX

As of: 2/7/12

Qty	Part #	Description	Spec	CL	TY	Heat Code/ Heat #	Yield	TS	Elg	C	Mn	P	S	Si	Cu	Cr	Yn	ACW	
	14784G		A-36			1014843	55,191	72,737	29.7	0.110	0.950	0.010	0.035	0.180	0.310	0.00	0.120	0.003	4
2	14785G	6'0 POST/8.5#/3HI TX	A-36			1013710	50,597	70,003	26.7	0.110	0.970	0.012	0.032	0.180	0.270	0.00	0.140	0.004	4
2	14786G	6'0 POST/8.5#/TRANS TX	A-36			1014843	55,191	72,737	29.7	0.110	0.950	0.010	0.035	0.180	0.310	0.00	0.120	0.003	4
2	32218G	T10/TRAN/TB-WB/ASYM/R	M-180	B	2	24240	66,000	77,100	33.1	0.060	1.250	0.011	0.004	0.021	0.030	0.04	0.030	0.004	4
2	35247A	CONN PL 40"x20" RT MO	A-36			B056774	59,800	70,100	31.9	0.200	0.410	0.010	0.007	0.060	0.290	0.00	0.080	0.001	4

TL-3 or TL-4 COMPLIANT when installed according to manufactures specifications

Upon delivery, all materials subject to Trinity Highway Products, LLC Storage Stain Policy No. LG-002.

ALL STEEL USED WAS MELTED AND MANUFACTURED IN USA AND COMPLIES WITH THE BUY AMERICA ACT.

ALL GUARDRAIL MBETS AASHTO M-180, ALL STRUCTURAL STEEL MBETS ASTM A36

ALL COATINGS PROCESSES OF THE STEEL OR IRON ARE PERFORMED IN USA AND COMPLIES WITH THE "BUY AMERICA ACT"

ALL GALVANIZED MATERIAL CONFORMS WITH ASTM-123, UNLESS OTHERWISE STATED.

BOLTS COMPLY WITH ASTM A-307 SPECIFICATIONS AND ARE GALVANIZED IN ACCORDANCE WITH ASTM A-153, UNLESS OTHERWISE STATED.

NUTS COMPLY WITH ASTM A-563 SPECIFICATIONS AND ARE GALVANIZED IN ACCORDANCE WITH ASTM A-153, UNLESS OTHERWISE STATED.

WASHERS COMPLY WITH ASTM F-436 SPECIFICATION AND/OR F-844 AND ARE GALVANIZED IN ACCORDANCE WITH ASTM F-2329.

3/4" DIA CABLE 6X19 ZINC COATED SWAGED END AISI C-1035 STEEL ANNEALED STUD 1" DIA ASTM 449 AASHTO M30, TYPE II BREAKING

STRENGTH - 49100 LB



# Certified Analysis

Trinity Highway Products, LLC  
2548 N.E. 28th St.  
Ft Worth, TX 76111

Order Number: 1164715  
Customer PO: Samples  
BOL Number: 40480  
Document #: 1  
Shipped To: TX  
Use State: TX

As of: 2/7/12

Customer: SAMPLES, TESTING, TRAINING MTRLS  
2525 STEMMONS FRWY  
DALLAS, TX 75207

Project: SAMPLES & TESTING TRAINING MTRLS

State of Texas, County of Tarrant. Sworn and subscribed before me this 7th day of February, 2012

Notary Public:  
Commission Expires: / /



*Jonary Luginsland*

Trinity Highway Products, LLC  
*Jonary Luginsland*  
Certified By: \_\_\_\_\_  
Quality Assurance



CMC STEEL TEXAS  
1 STEEL MILL DRIVE  
SEGUIN TX 78155-7510

CERTIFIED MILL TEST REPORT  
For additional copies call  
830-372-8771

We hereby certify that the test results presented here  
are accurate and conform to the reported grade specification

*Daniel J. Schacht*  
Daniel J. Schacht

Quality Assurance Manager

HEAT NO.: 3029770 SECTION: REBAR 13MM (#4) 20'0" 420/60 GRADE: ASTM A615-09b Gr 420/60 ROLL DATE: 01/22/2012 MELT DATE: 01/15/2012		S	O	L	D	T	O
CMC Construction Svcs College Stati 10650 State Hwy 30 College Station TX US 77845-7950 979 774 5900		S	H	I	P	T	O
CMC Construction Svcs College Stati 10650 State Hwy 30 College Station TX US 77845-7950 979 774 5900		CMC Construction Svcs College Stati 10650 State Hwy 30 College Station TX US 77845-7950 979 774 5900					
Delivery#: 80681077 BOL#: 70240462 CUST PO#: 53534v CUST P/N: DLVRY LBS / HEAT: 43820.000 LB DLVRY PCS / HEAT: 3280 EA							
Characteristic	Value	Characteristic Value					
C	0.45%						
Mn	0.83%						
P	0.009%						
S	0.034%						
Si	0.18%						
Cu	0.41%						
Cr	0.15%						
Ni	0.22%						
Mo	0.070%						
V	0.002%						
Cb	0.002%						
Sn	0.014%						
Al	0.002%						
Yield Strength test 1	65.7ksi						
Tensile Strength test 1	102.8ksi						
Elongation test 1	12%						
Elongation Gage Lgth test 1	8IN						
Bend Test Diameter	1.750IN						
Bend Test 1	Passed						

THIS MATERIAL IS FULLY KILLED, 100% MELTED AND MANUFACTURED IN THE USA, WITH NO WELD REPAIR OR MERCURY CONTAMINATION IN THE PROCESS.  
REMARKS :



CMC STEEL TEXAS  
1 STEEL MILL DRIVE  
SEGUIN TX 78155-7510

**CERTIFIED MILL TEST REPORT**  
For additional copies call  
830-372-8771

We hereby certify that the test results presented here  
are accurate and conform to the reported grade specification

*Daniel J. Schacht*  
Daniel J. Schacht  
Quality Assurance Manager

HEAT NO.: 3028494 SECTION: REBAR 16MM (#5) 20'0" 420/60 GRADE: ASTM A615-09b Gr. 420/60 ROLL DATE: 11/18/2011 MELT DATE: 11/14/2011		S	CMC Construction Svcs College Stati	S	CMC Construction Svcs College Stati	H	CMC Construction Svcs College Stati	Delivery#: 80669347 BOL#: 70236513 CUST PO#: 5434V CUST P/N: DLVRY LBS / HEAT: 45990.000 LB DLVRY PCS / HEAT: 2205 EA	
Characteristic	Value	L	10650 State Hwy 30 College Station TX US 77845-7950 979 774 5900	P	10650 State Hwy 30 College Station TX US 77845-7950 979 774 5900	T		Characteristic	Value
C	0.38%	O		O					
Mn	1.00%								
P	0.015%								
S	0.030%								
Si	0.22%								
Cu	0.33%								
Cr	0.21%								
Ni	0.19%								
Mo	0.088%								
V	0.003%								
Cb	0.001%								
Sn	0.013%								
Al	0.002%								
Yield Strength test 1	68.3ksi								
Tensile Strength test 1	108.1ksi								
Elongation test 1	15%								
Elongation Gage Lgth test 1	8IN								
Bend Test Diameter	2.188IN								
Bend Test 1	Passed								

THIS MATERIAL IS FULLY KILLED, 100% MELTED AND MANUFACTURED IN THE USA, WITH NO WELD REPAIR OR MERCURY CONTAMINATION IN THE PROCESS.

REMARKS :



# APPENDIX C. SOIL STRENGTH DOCUMENTATION

**Table C1. Test Day Static Soil Strength Documentation for Test No. 490022-4.**

<p style="text-align: center;"><b>Comparison of Static Load Test Results and Required Minimum: Load versus Displacement at 25 inch Height</b></p>	<p style="text-align: center;"><b>Static Load Setup</b></p>
<p style="text-align: center;"><b>Percent Finer Vs. Grain Size of Fill Soil for Dynamic and Static Load Tests</b></p>	<p style="text-align: center;"><b>Post-Test Photo of Post</b></p>

Date ..... 2012-05-14  
 Test Facility and Site Location ..... TTI Proving Ground—3100 SH 47, Bryan, TX  
 In Situ Soil Description (ASTM D2487) ..... Sandy gravel with silty fines  
 Fill Material Description (ASTM D2487) and sieve analysis ..... AASHTO Grade B Soil-Aggregate (see sieve analysis)  
 Description of Fill Placement Procedure ..... 6-inch lifts tamped with a pneumatic compactor

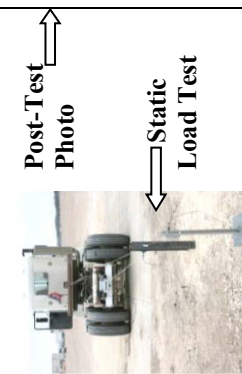
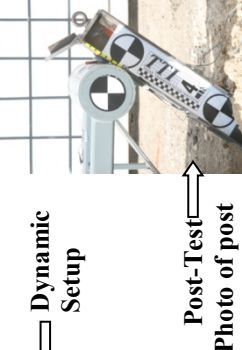
**Table C2. Summary of Strong Soil Test Results for Establishing Installation Procedure.**

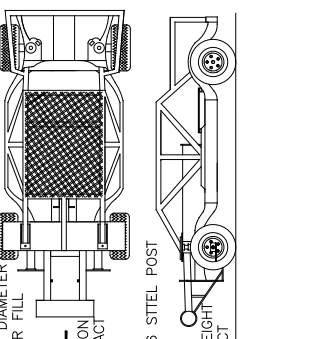
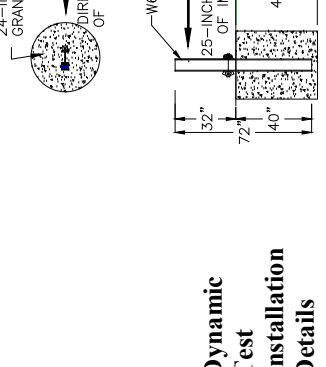
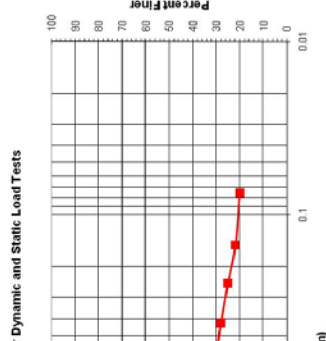
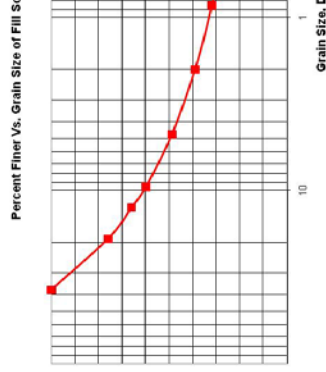
 <p style="text-align: center;"><b>Post-Test Photo</b></p>	 <p style="text-align: center;"><b>Static Load Test</b></p>	 <p style="text-align: center;"><b>Dynamic Setup</b></p>	 <p style="text-align: center;"><b>Post-Test Photo of post</b></p>
 <p style="text-align: center;"><b>Dynamic Test Installation Details</b></p>	 <p style="text-align: center;"><b>Static Load Test Installation Details</b></p>	 <p style="text-align: center;"><b>Percent Filter vs. Grain Size of Fill Soil for Dynamic and Static Load Tests</b></p>	 <p style="text-align: center;"><b>Comparison of Load vs. Displacement at 25-inch height</b></p>
<p>Date.....</p>	<p>2008-11-05</p>	<p>Test Facility and Site Location .....</p>	<p>TTI Proving Ground, 3100 SH 47, Bryan, TX 77807</p>
<p>In Situ Soil Description (ASTM D2487) .....</p>	<p>Sandy gravel with silty fines</p>	<p>Fill Material Description (ASTM D2487) and sieve analysis .....</p>	<p>AASHTO Grade B Soil-Aggregate (see sieve analysis above)</p>
<p>Description of Fill Placement Procedure .....</p>	<p>6-inch lifts tamped with a pneumatic compactor</p>	<p>Bogie Weight .....</p>	<p>5009 lb</p>
<p>Impact Velocity .....</p>	<p>20.5 mph</p>	<p></p>	<p></p>

# APPENDIX D. TEST VEHICLE PROPERTIES AND INFORMATION

**Table D1. Vehicle Properties for Test No. 490022-4.**

Date: 2012-05-11 Test No.: 490022-4 VIN No.: 1D7HA182365659981  
 Year: 2006 Make: Dodge Model: Ram 1500  
 Tire Size: P265/70R17 Tire Inflation Pressure: 35 psi  
 Tread Type: Highway Odometer: 180713

Note any damage to the vehicle prior to test: \_\_\_\_\_

• Denotes accelerometer location.

NOTES: \_\_\_\_\_  
 \_\_\_\_\_

Engine Type: V-8  
 Engine CID: 4.7 liter

Transmission Type:  
 Auto or \_\_\_\_\_ Manual  
 FWD  RWD  4WD

Optional Equipment: \_\_\_\_\_

Dummy Data:  
 Type: No dummy  
 Mass: \_\_\_\_\_  
 Seat Position: \_\_\_\_\_

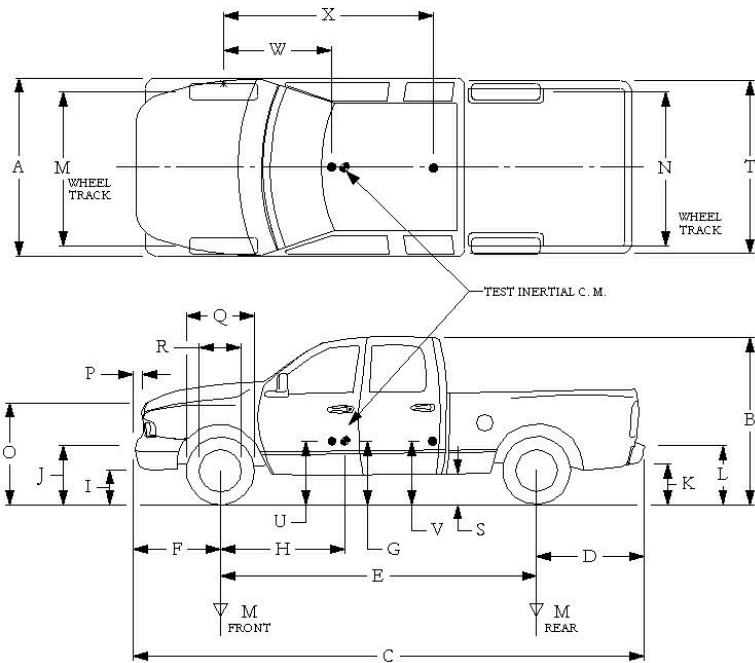

**Geometry:** inches

A	<u>78.25</u>	F	<u>36.00</u>	K	<u>20.50</u>	P	<u>2.88</u>	U	<u>28.50</u>
B	<u>75.00</u>	G	<u>28.31</u>	L	<u>29.12</u>	Q	<u>31.25</u>	V	<u>29.50</u>
C	<u>223.75</u>	H	<u>60.39</u>	M	<u>68.50</u>	R	<u>18.38</u>	W	<u>60.50</u>
D	<u>47.25</u>	I	<u>13.75</u>	N	<u>68.00</u>	S	<u>12.00</u>	X	_____
E	<u>140.50</u>	J	<u>25.38</u>	O	<u>44.50</u>	T	<u>77.00</u>		
Wheel Center Height Front	<u>14.75</u>	Wheel Well Clearance (Front)	<u>5.00</u>	Bottom Frame Height - Front	<u>17.12</u>				
Wheel Center Height Rear	<u>14.75</u>	Wheel Well Clearance (Rear)	<u>10.25</u>	Bottom Frame Height - Rear	<u>24.75</u>				

RANGE LIMIT: A=78 ±2 inches; C=237 ±13 inches; E=148 ±12 inches; F=39 ±3 inches; G = > 28 inches; H = 63 ±4 inches; O=43 ±4 inches; M+N/2=67 ±1.5 inches

GVWR Ratings:	Mass: lb	Curb	Test Inertial	Gross Static
Front <u>3700</u>	$M_{front}$ _____	<u>2875</u>	<u>2852</u>	_____
Back <u>3900</u>	$M_{rear}$ _____	<u>2151</u>	<u>2150</u>	_____
Total <u>6700</u>	$M_{Total}$ _____	<u>5026</u>	<u>5002</u>	_____

(Allowable Range for TIM and GSM = 5000 lb ±110 lb)

**Mass Distribution:**

lb LF: 1424 RF: 1428 LR: 1066 RR: 1084

**Table D2. Vehicle Parametric Measurements for Test No. 490022-4.**

Date: 2012-05-11 Test No.: 490022-4 VIN: 1D7HA182365659981  
 Year: 2006 Make: Dodge Model: Ram 1500  
 Body Style: Quad cab Mileage: 180713  
 Engine: 4.7 liter V-8 Transmission: \_\_\_\_\_  
 Fuel Level: Empty Ballast: 120 lb at front of bed (440 lb max)  
 Tire Pressure: Front: 35 psi Rear: 35 psi Size: 265/70R17

<b>Measured Vehicle Weights:</b> (lb)			
LF:	<u>1424</u>	RF:	<u>1428</u>
Front Axle:		<u>2852</u>	
LR:	<u>1066</u>	RR:	<u>1084</u>
Rear Axle:		<u>2150</u>	
Left:	<u>2490</u>	Right:	<u>2512</u>
Total:		<u>5002</u>	
5000 ±110 lb allowed			
Wheel Base:	<u>140.5</u> inches	Track: F:	<u>68.5</u> inches
148 ±12 inches allowed		R:	<u>68</u> inches
		Track = (F+R)/2 = 67 ±1.5 inches allowed	
<b>Center of Gravity, SAE J874 Suspension Method</b>			
X:	<u>60.39</u> in	Rear of Front Axle	(63 ±4 inches allowed)
Y:	<u>0.15</u> in	Left - Right +	of Vehicle Centerline
Z:	<u>28.31</u> in	Above Ground	(minimum 28.0 inches allowed)

Hood Height: 44.50 inches Front Bumper Height: 25.38 inches  
 43 ±4 inches allowed

Front Overhang: 36.00 inches Rear Bumper Height: 29.18 inches  
 39 ±3 inches allowed

Overall Length: 223.75 inches  
 237 ±13 inches allowed



**Table D3. Exterior Crush Measurements for Test No. 490022-4.**

Date: 2012-05-11 Test No.: 490022-4 VIN No.: 1D7HA182365659981  
 Year: 2006 Make: Dodge Model: Ram 1500

**VEHICLE CRUSH MEASUREMENT SHEET<sup>1</sup>**

Complete When Applicable	
End Damage	Side Damage
Undeformed end width _____  Corner shift: A1 _____ A2 _____  End shift at frame (CDC) (check one) < 4 inches _____ ≥ 4 inches _____	Bowing: B1 _____ X1 _____ B2 _____ X2 _____  Bowing constant $\frac{X1 + X2}{2} = \underline{\hspace{2cm}}$

Note: Measure C<sub>1</sub> to C<sub>6</sub> from Driver to Passenger side in Front or Rear impacts – Rear to Front in Side Impacts.

Specific Impact Number	Plane* of C-Measurements	Direct Damage		Field L**	C <sub>1</sub>	C <sub>2</sub>	C <sub>3</sub>	C <sub>4</sub>	C <sub>5</sub>	C <sub>6</sub>	±D
		Width** (CDC)	Max*** Crush								
1	Front plane at bumper ht	16.0	10.0	27	0	2	4	4	6	10	+10.5
2	Side plane at bumper ht	16.0	17.0	50	1	4	--	---	15	17	+69
	Measurements recorded										
	<b>in inches</b>										

<sup>1</sup>Table taken from National Accident Sampling System (NASS).

\*Identify the plane at which the C-measurements are taken (e.g., at bumper, above bumper, at sill, above sill, at beltline, etc.) or label adjustments (e.g., free space).

Free space value is defined as the distance between the baseline and the original body contour taken at the individual C locations. This may include the following: bumper lead, bumper taper, side protrusion, side taper, etc. Record the value for each C-measurement and maximum crush.

\*\*Measure and document on the vehicle diagram the beginning or end of the direct damage width and field L (e.g., side damage with respect to undamaged axle).

\*\*\*Measure and document on the vehicle diagram the location of the maximum crush.

Note: Use as many lines/columns as necessary to describe each damage profile.

**Table D4. Occupant Compartment Measurements for Test No. 490022-4.**

Date: 2012-05-11 Test No.: 490022-4 VIN No.: 1D7HA182365659981  
 Year: 2006 Make: Dodge Model: Ram 1500

**OCCUPANT COMPARTMENT DEFORMATION MEASUREMENT**

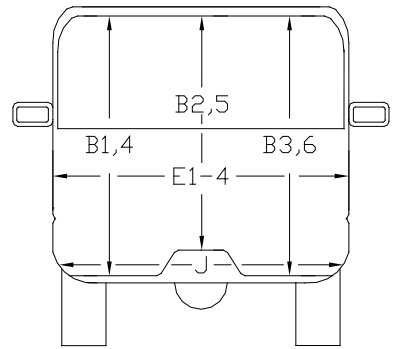
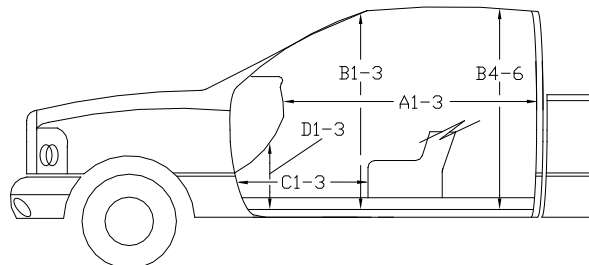
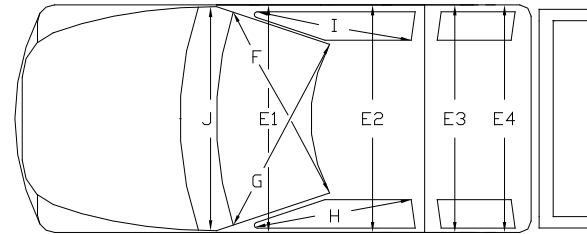

	<b>Before</b> ( inches )	<b>After</b> ( inches )
A1	64.50	64.50
A2	64.50	64.50
A3	65.00	65.00
B1	45.25	45.25
B2	39.25	39.25
B3	45.25	45.25
B4	42.00	42.00
B5	42.50	42.50
B6	42.00	42.00
C1	27.25	27.25
C2	----	----
C3	29.25	27.50
D1	12.75	12.75
D2	----	----
D3	11.25	11.75
E1	63.00	61.50
E2	64.50	64.00
E3	64.00	63.00
E4	64.50	63.75
F	60.00	59.50
G	60.00	60.00
H	39.00	39.00
I	39.00	39.00
J*	63.25	59.75

\*Lateral area across the cab from driver's side kickpanel to passenger's side kickpanel.

## APPENDIX E. SEQUENTIAL PHOTOGRAPHS



0.000 s



0.049 s



0.098 s

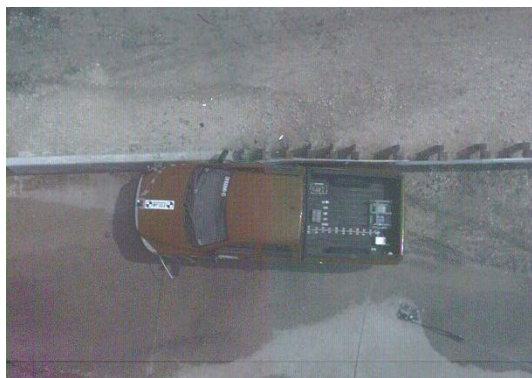

0.147 s



**Figure E1. Sequential Photographs for Test No. 490022-4  
(Overhead and Frontal Views).**



0.196s



0.245 s



0.294 s



0.343 s

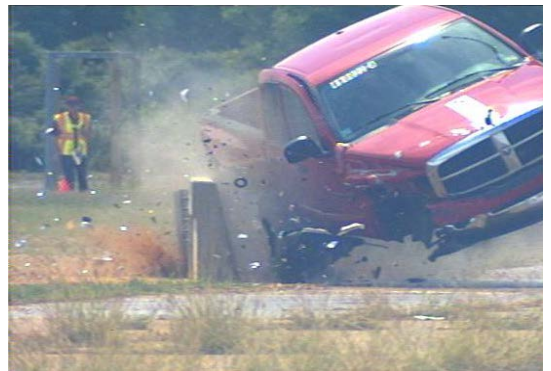

**Figure E1. Sequential Photographs for Test No. 490022-4 (Overhead and Frontal Views) (continued).**



0.000 s



0.196 s



0.049 s



0.245 s



0.098 s



0.294 s



0.147 s



0.343 s

**Figure E2. Sequential Photographs for Test No. 490022-4 (Rear View).**



# APPENDIX F. VEHICLE ANGULAR DISPLACEMENTS AND ACCELERATIONS

## Roll, Pitch, and Yaw Angles

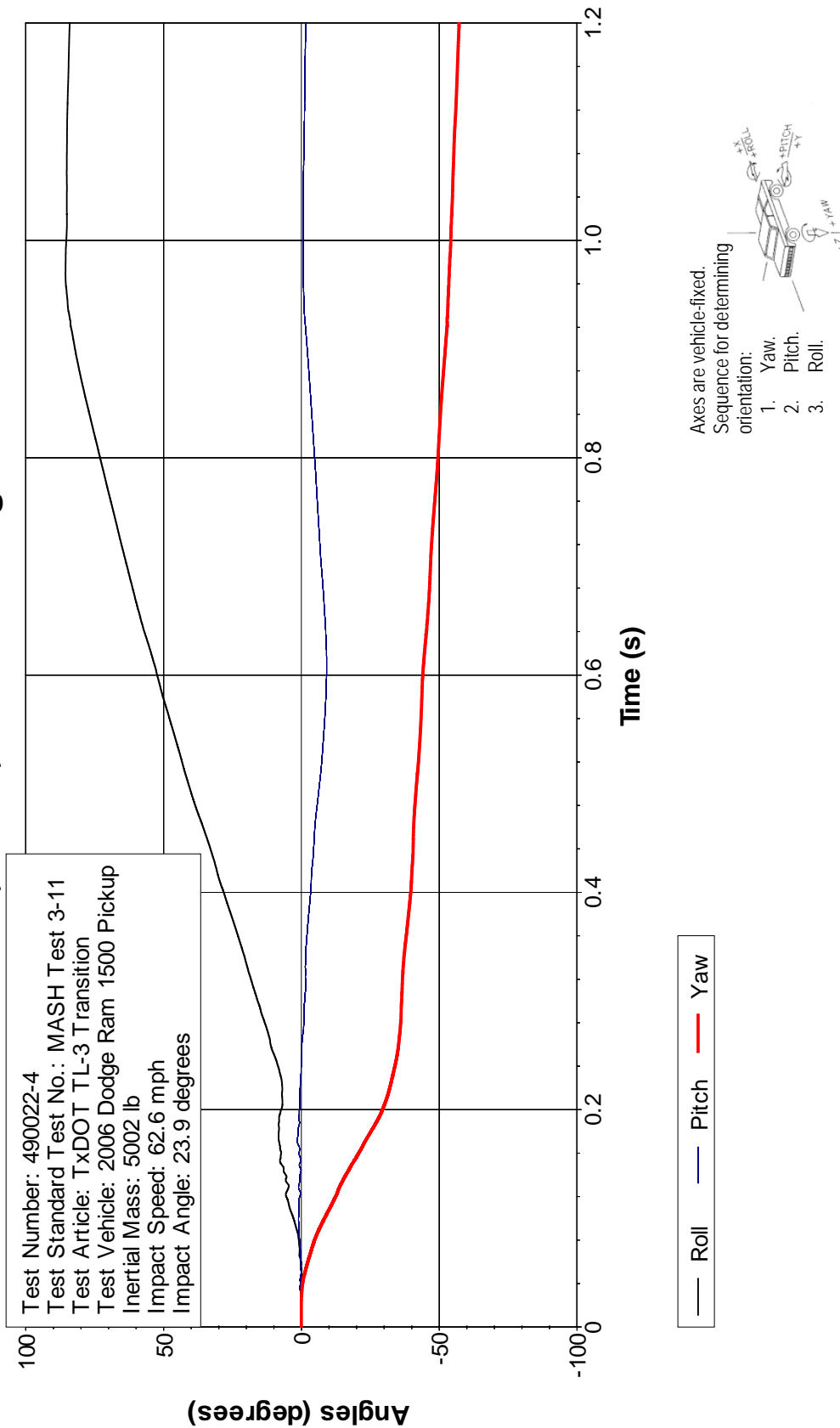
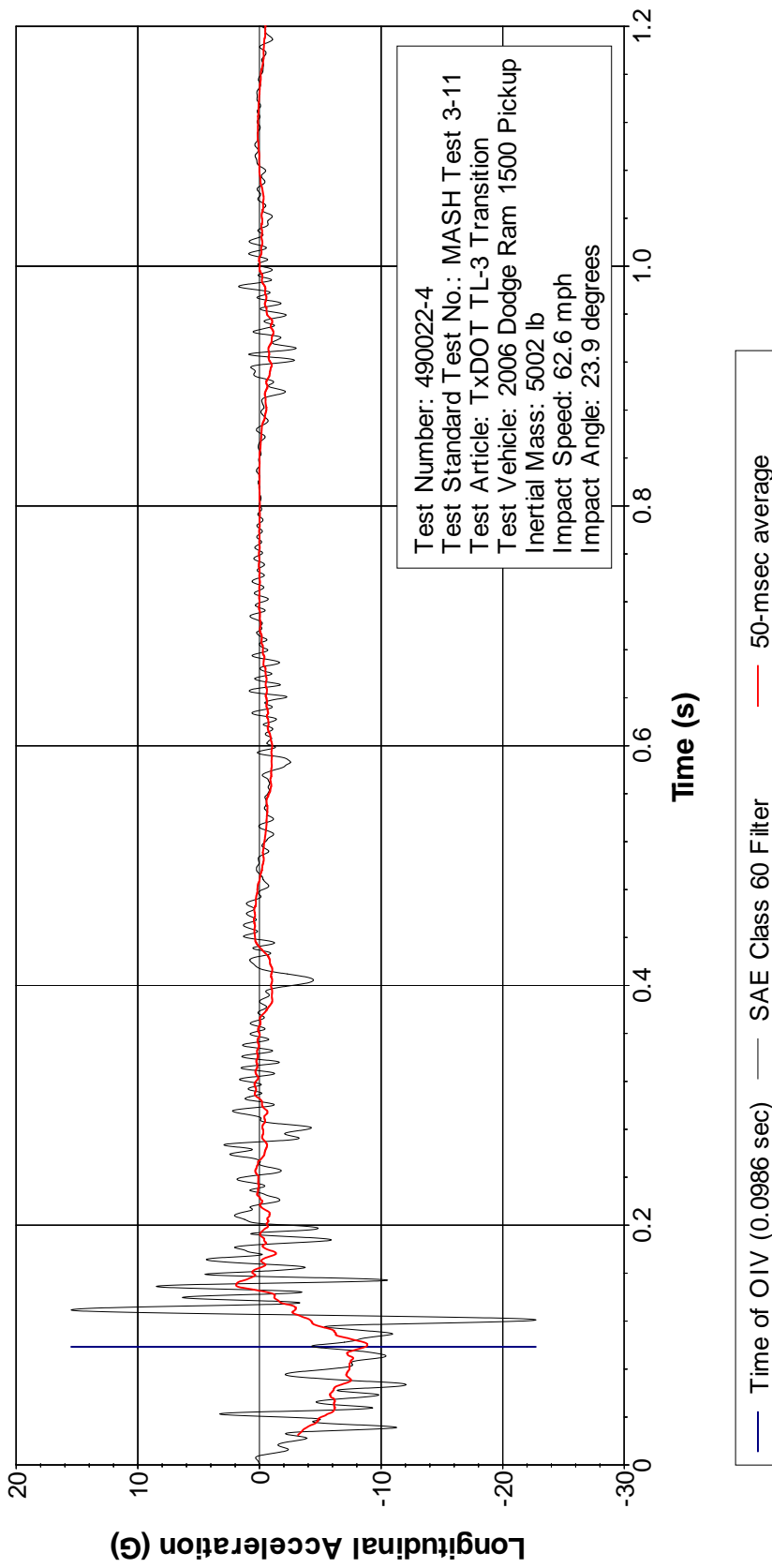

Figure F1. Vehicle Angular Displacements for Test No. 490022-4.

# X Acceleration at CG



**Figure F2. Vehicle Longitudinal Accelerometer Trace for Test No. 490022-4 (Accelerometer Located at Center of Gravity).**



# Y Acceleration at CG

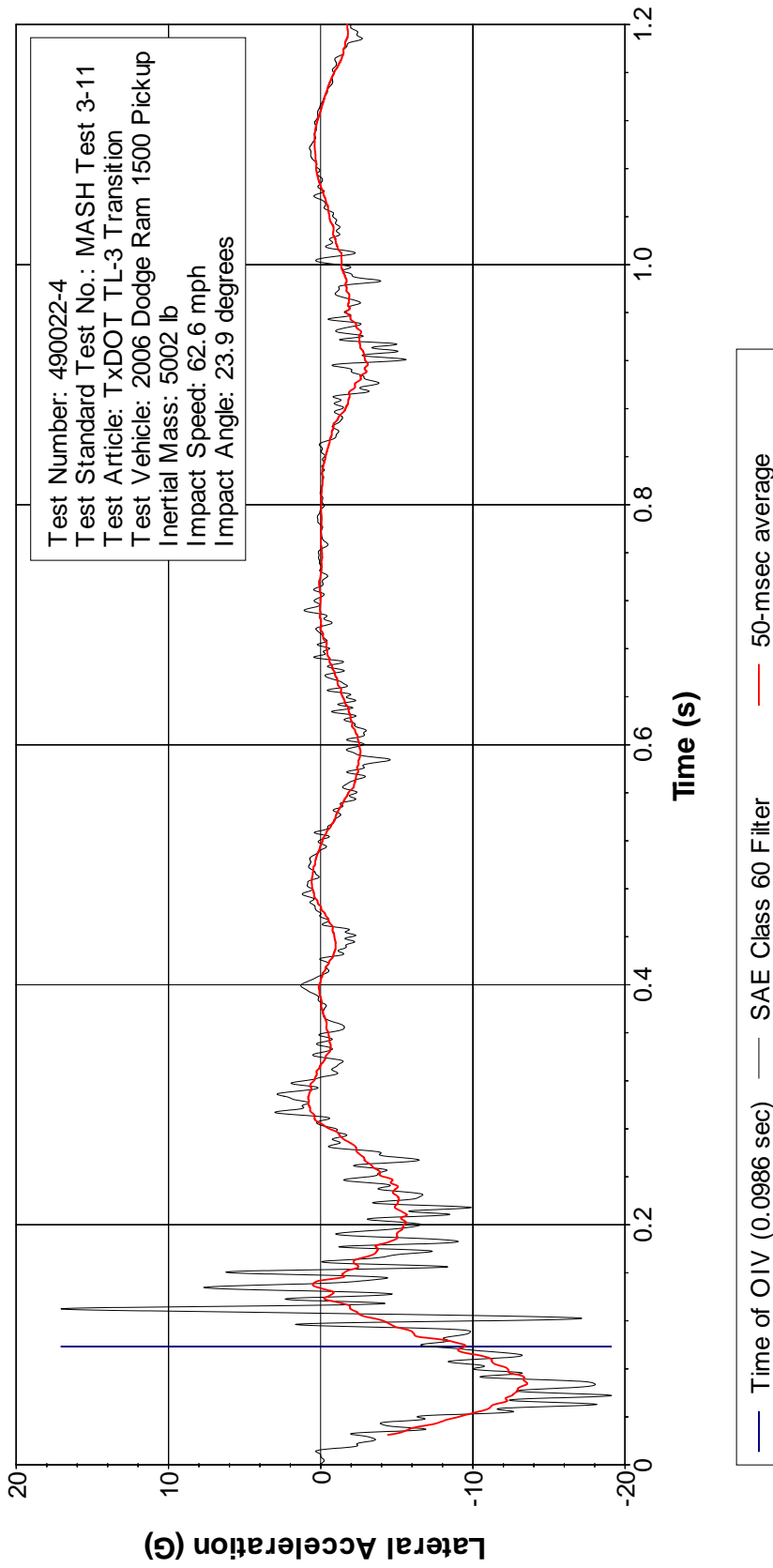

**Figure F3. Vehicle Lateral Accelerometer Trace for Test No. 490022-4 (Accelerometer Located at Center of Gravity).**

# Z Acceleration at CG

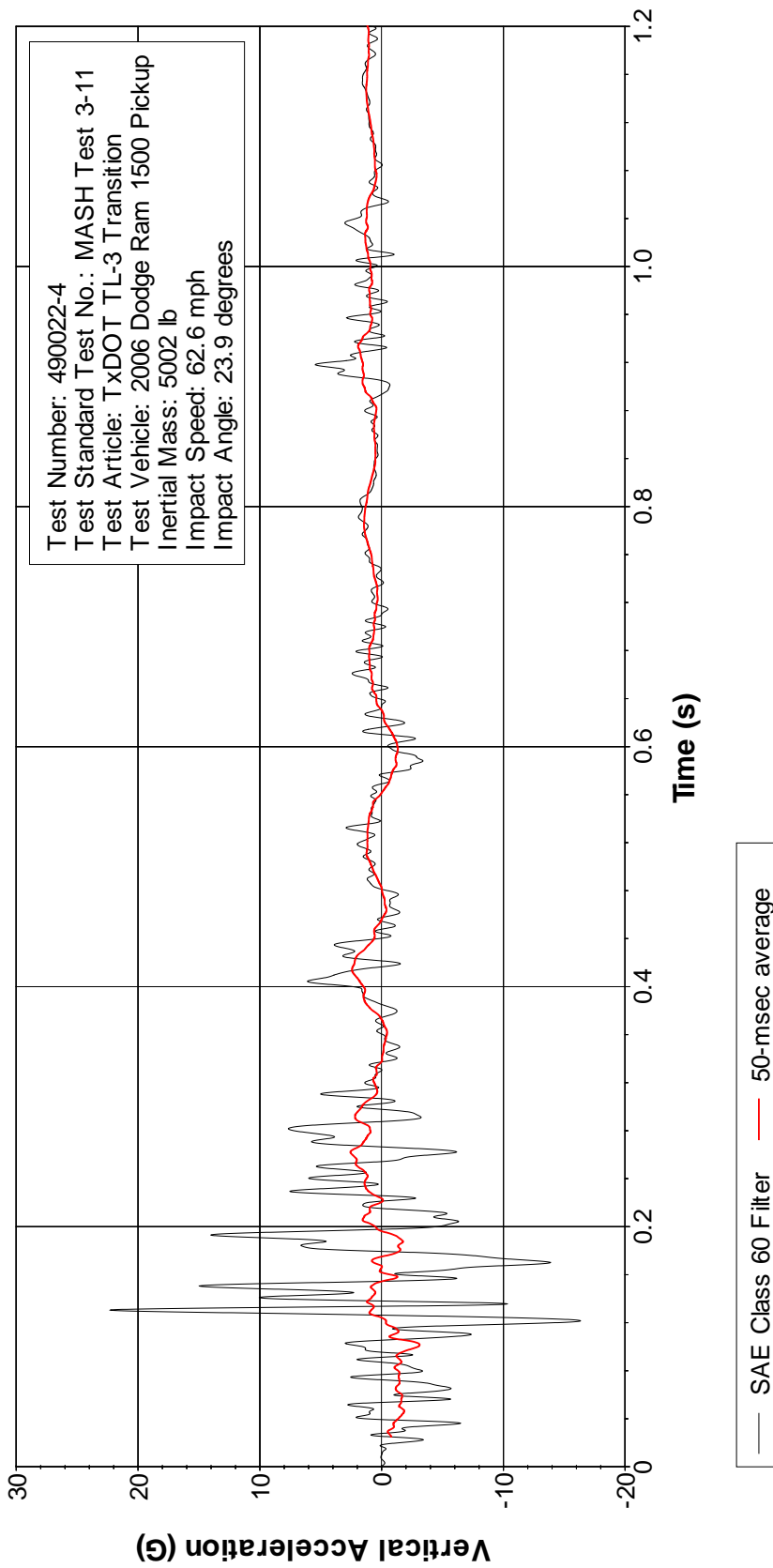

**Figure F4. Vehicle Vertical Accelerometer Trace for Test No. 490022-4 (Accelerometer Located at Center of Gravity).**

# X Acceleration Rear of CG

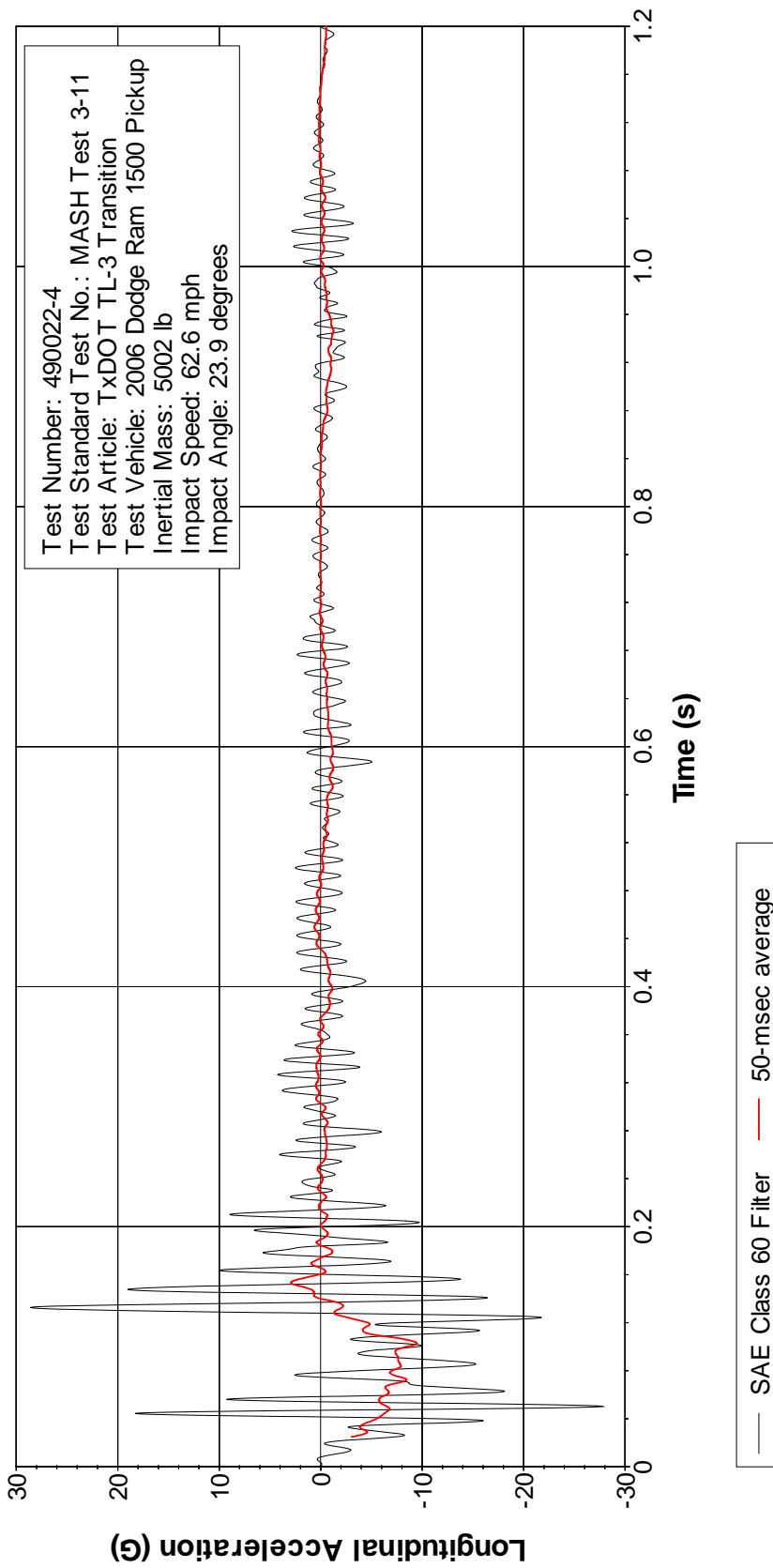

**Figure F5. Vehicle Longitudinal Accelerometer Trace for Test No. 490022-4 (Accelerometer Located Rear of Center of Gravity).**

# Y Acceleration Rear of CG

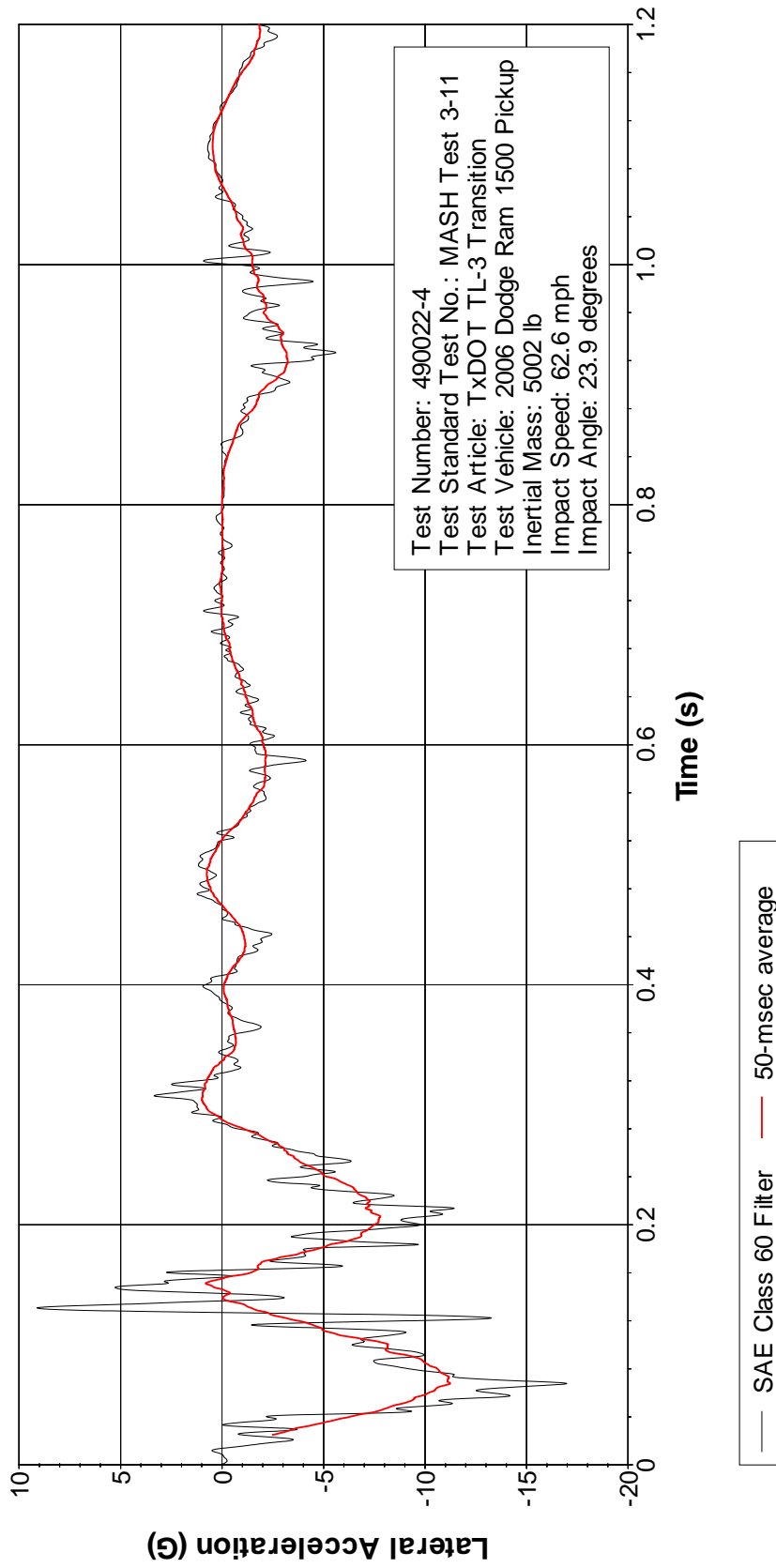
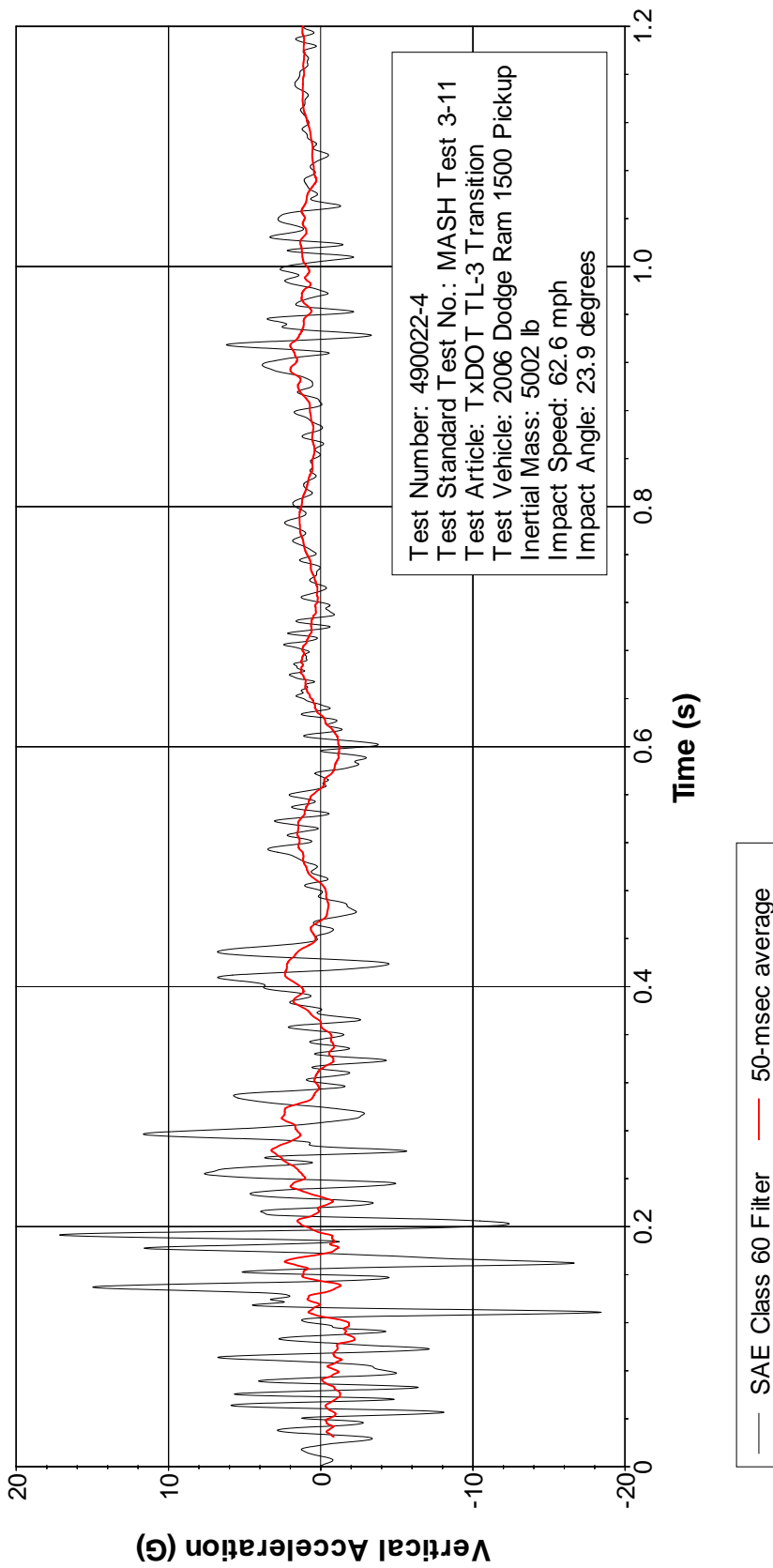

Figure F6. Vehicle Lateral Accelerometer Trace for Test No. 490022-4 (Accelerometer Located Rear of Center of Gravity).

# Z Acceleration Rear of CG



**Figure F7. Vehicle Vertical Accelerometer Trace for Test No. 490022-4 (Accelerometer Located Rear of Center of Gravity).**

